

SPECIAL ISSUE 02 | 2019

TOOLS,
TECHNOLOGIES
AND SYSTEM INTEGRATION FOR THE

SMART AND SUSTAINABLE CITIES

TO COME

on behalf of EERA Joint Programme
on Smart Cities



**International Journal of
Sustainable Energy Planning and Management**

Volume 24 2019

SPECIAL ISSUE 02 | 2019

TOOLS,
TECHNOLOGIES
AND SYSTEM INTEGRATION FOR THE

SMART AND SUSTAINABLE CITIES

TO COME

on behalf of EERA Joint Programme
on Smart Cities



**International Journal of
Sustainable Energy Planning and Management**

Volume 24 2019

SPECIAL ISSUE 02|2019

Tools, technologies and systems integration for the Smart and Sustainable Cities to come

on behalf of EERA JOINT PROGRAMME on SMART CITIES

Host Editor and Coordinator for the Integrative Scientific and Editorial Board Special Issue 02|2019 EERA JP on Smart Cities

Paola Clerici Maestosi, ENEA, Italy

Integrative Editorial Board for Special Issue 02|2019 EERA JP on Smart Cities

Laura Aeleni, LNEG, Portugal

Hans-Martin Neumann, AIT, Austria

Annemie Wyckmans, NTNU, Norway

Dorota Chwieduk ITC PW, Poland

Wojciech Bujalski, ITC PW, Poland

Assistant editor for Special Issue 02|2019 EERA JP on Smart Cities

Paolo Civiero, IREC, Spain

Journal editor in Chief

Poul Alberg Østergaard, Aalborg University - poul@plan.aau.dk - Rendsburggade 14, 9000 Aalborg, Denmark

Editorial Board

Isabel Soares, Universidade do Porto, Portugal

Erik O. Ahlgren, Chalmers University of Technology, Sweden

Christian Doetsch, Fraunhofer Institute for Environ., Safety, and Energy Technology UMSICHT, Germany

Frede Hvelplund, Aalborg University, Denmark

Bernd Möller, University of Flensburg, Germany

Brian Vad Mathiesen, Aalborg University, Denmark

Karl Sperling, Aalborg University, Denmark

Paula Varandas Ferreira, Universidade do Minho, Portugal

Sven Werner, Halmstad University, Sweden

Anthony Michael Vassallo, University of Sydney, Australia

Neven Duic, University of Zagreb, Croatia

H Yang, The Hong Kong Polytechnic University, Hong Kong

Henrik Lund, Aalborg University, Denmark

Jeremiah K Kiplagat, Kenyatta University, Kenya

Michael Saul Isaacson, University of California, United States

David Toke, University of Aberdeen, United Kingdom

Erling Holden, Sogn og Fjordane University College, Norway

David Connolly, Aalborg University, Denmark

Alice Moncaster, University of Cambridge, United Kingdom

Matthew Lockwood, University of Exeter, United Kingdom

Volkmar Lauber, University of Salzburg, Austria,

Robert Lowe, University College London, United Kingdom

Maarten Arentsen, University of Twente, Netherlands

Tao Ma, Shanghai Jiao Tong University, China

ISSN 2246-2929

DOI <https://doi.org/10.5278/ijsepm.vol24>

Published by Aalborg University Press

Journal website journals.aau.dk/index.php/sepm

Layout Esben Norby Clemens, Aalborg University, Denmark (Front page & Logo)

DiTech Process Solutions, Mumbai, India - www.ditechps.com

Sponsors Danfoss, PlanEnergi, and EMD International



EERA JPSC SPECIAL ISSUE 02|2019

SPECIAL ISSUE 02|2019

Tools, technologies and systems integration for the Smart and Sustainable Cities to come

on behalf of EERA JOINT PROGRAMME on SMART CITIES

OPENING

- 01 | Tools, technologies and system integration for the Smart and Sustainable Cities to come
by Poul Alberg Østergaard and Paola Clerici Maestosi
- 07 | European Union funding Research Development and Innovation projects on Smart Cities: the state of the art in 2019
by Paola Clerici Maestosi, Paolo Civiero and Gilda Massa

RESEARCH AND EXPERIMENTATION

- 21 | Modelling the future low-carbon energy systems – case study of Greater Copenhagen, Denmark
by Sara Ben Amer, Rasmus Bramstoft, Olexandr Balyk and Per Sievert Nielsen
- 33 | Low temperature district heating networks for complete energy needs fulfillment
by Maria Alessandra Ancona, Michele Bianchi, Lisa Branchini, Andrea De Pascale, Francesco Melino and Antonio Peretto
- 43 | Simulation of an alternative energy system for district heating company in the light of changes in regulations of the emission of harmful substances into atmosphere
by Maciej Widzinski, Patryk Chaja, Anders N. Andersen, Marta Jaroszewska, Sebastina Bykuc, and Jakub Sawicki
- 57 | Interconnection of the electricity and heating sectors to support the energy transition in cities
by Verena Heinisch, Lisa Goransson, Mikael Odenberger and Filip Johnsson
- 67 | How can urban manufacturing contribute to a more sustainable energy system in cities?
by Tanja Totzer, Romana Stollnberger, Roland Krebs, Mara Haas and Christoph Biegler
- 75 | Sustainable Energy Management: are tourism SMEs in Poland ready for Circular Economy solutions?
by Marta Jaroszewska, Patryk Chaja and Anna Dziadkiewicz
- 85 | Sharing Cities: from vision to reality. A people, place and platform approach to implement Milan's smart city strategy
by Elisa Cassinandri, Elisa Gambarini, Roberto Nocerino and Lucia Scopelliti
- 95 | Solutions and services for smart sustainable district: Innovative Key Performance Indicators to support transition
by Carola Clemente, Paolo Civiero and Marilisa Cellurale
- 107 | Experimental demonstration of a smart homes network in Rome
by Sabrina Romano, Martina Botticelli and Francesca Dionisi
- 115 | Spatial aggregation and visualization of urban heat demand using graph theory. An example from Hamburg, Germany
by Ivan Dochev, Hannes Seller and Irene Peters
- 125 | Supporting tool for multi-scale energy planning through procedures of data enrichment
by Francisco Javier Miguel-Herrero, Victor Ivan Serna-Gonzalez and Gema Hernandez-Moral
- 135 | Decision support system for smart urban management: resilience against natural phenomena and aerial environmental assessment
by Sergi Taraglio, Stefano Chiesa, Luigi La Porta, Maurizio Pollino, Marco Verdecchia, Barbara Tomassetti, Valentina Colaiuda and Annalisa Lomabardi
- 147 | Sustainable energy planning as a co-creative governance challenge. Lesson learnt from the Zero Village Bergen
by Savis Gohari and Stig Larssaether
- 155 | Smart community co-creation: the case of the centocelle project
by Francesca Cappellaro, Roberta Chiarini, Claudia Meloni and Claudia Snels

DIALOGUE

- 163 | Virtual round table on innovation for smart and sustainable cities
with the contribution of Paola Clerici Maestosi, Peter Berkowitz, Han Brezet, Jonas Bylund and Giovanni Vetrutto
- 164 | Foreword
by Peter Berkowitz
- 167 | Point of view
by Han Brezet, Jonas Bylund and Giovanni Vetrutto

CONTRIBUTIONS

- 179 | Opening authors
- 180 | Research and experimentation authors
- 181 | Acknowledgement of value stakeholders
- 182 | Dialogues virtual round table participants
- 183 | EERA Joint Programme on Smart Cities full members
- 184 | EERA Joint Programme on Smart Cities associated partners



OPENING

Tools, technologies and systems integration for the Smart and Sustainable Cities to come

Poul Alberg Østergaard^{a*} and Paola Clerici Maestosi^b

^aAalborg University, Rendsburgade 14, 9000 Aalborg, Denmark

^bENEA Italian National Agency for New Technologies, Energy and Sustainable Economic Development, Energy Technologies Department, via Martiri di Monte Sole 4, 40129 Bologna, Italy

ABSTRACT

This paper introduces contemporary research on smart cities from the special issue of the International Journal of Sustainable Energy Planning and Management organised in conjunction with the EERA Joint Programme on Smart Cities. The topic - *Tools, technologies and systems integration for the Smart and Sustainable Cities to come* – highlights the variety of research within this field. From a starting point in a discussion on smart cities and smart energy systems, the paper goes on to describe new research findings within the wider area of smart cities and smart energy systems starting with cases of transition, moving on to data requirements and data generation for designing transitions and ending with theories and methodologies for designing transitions.

Keywords:

Smart cities;
Smart energy systems;
Environmental impact;

URL: <http://doi.org/10.5278/ijsep.m.3405>

1. Introduction

Cities are faced with tremendous challenges arising from rapid population growth, decline outside economic hubs, environmental degradation, and social inequality but also increasing expectations of city services from citizens and businesses alike. In recent years, cities have started to recognize that Internet Communication Technology (ICT) could be essential for a vibrant social, economic and cultural life and that could play a central role in moving the energy systems towards a more sustainable path while limiting the dramatic increase in urban energy consumption and associated CO₂ emissions.

Thus, the paradigm of Smart Cities has marked research, development and innovation projects in the last five year. Now, however, it is time for the new paradigm of Smart Sustainable Cities that enable the decoupling of high quality life and economic growth from resource consumption and environmental impact. Thanks to, but not only to, ICT.

The European Energy Research Alliance (better known by its acronym EERA) Joint Programme on Smart Cities, which officially started in September 2010 as a network of researchers, experts and stakeholders, has been able to explore the multidimensional aspects which characterized first the paradigm of Smart Cities, now Smart and Sustainable Cities. Also, there are starting some reflections on Positive Energy District emerging as a future element of the Smart Cities paradigm.

The idea to create a special issue series on behalf of EERA Joint Programme on Smart Cities (JPSC) came in 2017 with the approval of new EERA JPSC Work Programme which organized the JPSC activities in seven Work Packages: the aim of *Work Package 4 Academy* - coordinated by Paola Clerici Maestosi – was and still is to boost academic interest and participation, and to strengthen cooperation among Research and Technologies Organizations and University partners as well as external stakeholders.

*Corresponding author e-mail address: poul@plan.aau.dk

Accordingly, the idea developed to create the special issue series, and subsequently a Scientific Board was established as well as a well-defined scientific-editorial work plan which main characteristic was to establish collaborations with existing scientific journals through the development of a special issue. Furthermore, the plan is to collaborate with scientific journals edited in different EU countries to ensure a geographic expansion of the work, and to boost discussion on:

- an European approach to Smart Cities, which is why firstly a special issue entitled *European pathways for the Smart Cities to come* was published with the journal *TECHNE* in 2018 [1,2];
- tools, technologies and system integration in Smart Cities which is why this second special issue entitled *Tools, technologies and systems integration for the Smart and Sustainable Cities to come* is published here in 2019
- Smart Cities as building block for tomorrow's low-carbon energy system for special issue 3 in 2020 with the potential title *Cities of tomorrow: Smart Sustainable Cities and Positive Energy District*.

So every year a new special issue is developed with a new host journal; 2018 was the time of *TECHNE*, an Italian scientific journal of technology on architecture and environment, while 2019 is the time of the Danish *International Journal of Sustainable Energy Planning and Management* which combines engineering with social science within energy system analyses, feasibility studies and public regulation.

Coming back to this special issue 2|2019 the decision to join IJSEPM relay on the opportunity to join two scientific communities oriented to complementary research fields with the mission to promote scientific dialogue in the field of technologies.

From the IJSEPM's perspective, energy systems in particular have a large impact on development and basically the human habitat, and a change needs to be planned and implemented [3], however there are more ways to address the challenge. On the one hand, the emission of greenhouse gasses may be limited by simply changing to carbon-neutral fuels, however this is often not optimal or within the constraints given by resource availability [4]. Integrated – or smart energy systems [5,6] – on the other hand, enables a further integration of renewable energy sources where the potential exploitation is limitless. This applies to e.g. wind power and

photo voltaics whose production shares are otherwise typically bounded by the temporal distribution of the electricity demand, the degree to which other production units in the system can regulate up and down and e.g. ancillary service supply. In smart energy system, such fluctuating energy sources are integrated using the entire energy system and drawing on low-cost energy storage particularly in the heating system [7].

While smart energy systems thus have a key-role to play in future energy systems, they also need to be coordinated with and coexist with smart cities, and indeed, the ICT solutions for Smart Cities will have as one its main requirements the ability to successfully coordinate the production, conversion, storage and consumption of all carriers of energy. This is a requirement for the successful transition to renewable energy sources, which are largely of a non-dispatchable nature.

In this special issue, a series of articles are presented, which advances the scientific knowledge within the nexus of Smart Cities, Smart Sustainable Cities and Smart Energy Systems with case of city or energy transition, data acquisition for planning purposes and tools and theories for transition studies.

The special starts with an article outlining European research projects and funding within smart cities [8] and ends with a virtual round table discussing the issues pertaining to smart cities [9].

2. Energy system transition

Outlining how cities have to take the lead due to inadequate national or international global warming mitigation policies, Ben Amer et al. investigate how an area may transition its energy system in their work *Modelling the future low-carbon energy systems - a case study of Greater Copenhagen, Denmark* [10]. Using the energy systems scenario development model Balmorel, they show how expanding the present district heating system in Copenhagen to a new development area is preferable. This article adds to the present body of work using the Balmorel model in the IJSEPM [11,12]

Ancona et al. take a starting point in how district heating combined with renewable energy usage can lead to energy savings in *Low temperature district heating networks for complete energy needs fulfillment* [13]. Further advances may be made through the lowering of the district heating supply temperature, which benefits both grid losses, the exploitation of heat sources and

efficiencies in the supply system. This work follows nicely in a tradition of low-temperature district heating studies published in the IJSEPM [14–16].

Using the energy plant design model energyPRO, Widzinski investigate the transition of a Polish coal-based power station to a natural-based cogeneration of heat and power station in the article *Simulation of an alternative energy system for district heating company in the light of changes in regulations of the emission of harmful substances into the atmosphere* [17]. This article follows up on previous work using the energyPRO model for simulating CHP systems published in this journal [18,19].

In *A city optimisation model for investigating energy system flexibility* [17], Heinisch et al. address the electrification of energy systems and how sector-integration using electricity as an system-internal energy carrier will play a more prominent role in future energy systems. The authors find amongst others that storage will increase the utility of power-to-heat technology. This is line with previous results on sector integration using the smart energy systems approach. [20–23]

Tötzer et al. investigate how urban manufacturing can be integrated into city energy systems in *How can Urban Manufacturing contribute to a more sustainable energy system in cities?* [24]. Manufacturing is changing, and while there on the one hand may be waste heat streams from industry to be tapped in, industry is also moving towards higher electricity demands. Thus in the future, urban manufacturing needs to be better integrated with other sectors and actors in the city.

Jaroszewska et al. address *A Sustainable energy management: are tourism SMEs in the South Baltic region ready?* [25] Their starting point is that the tourism industry needs to position itself, and that sustainability is one facet that European tourism industry can focus on. In their work, the authors focus on how energy management can assist the Polish tourism industry in developing. This article adds to the limited body of tourism-related work published in the IJSEPM [26].

In *Sharing Cities: from vision to reality. A people, place and platform approach to implement Milan's Smart City strategy* [27], Cassinadri et al. describes the first results of the project *Sharing Cities* aiming at developing smart districts in London, Lisbon and Milan.

Finally, in Cellurale et al.'s article *Solutions and services for smart sustainable district: an innovative approach in Key Performance Indicators to support*

transition [28], the authors look into Positive Energy Districts, and strategies for transitioning to smart energy districts.

3. Data for energy planning

In *Experimental demonstration of a smart homes network in Rome* [29], Romano describes a project in the Centocelle district in Rome where a so-called *Energy Box* collects data on energy consumption and indoor climate with a view to establishing the data foundation for a Urban Smart District. Data is gathered and may be used for monitoring the system, may be shared among citizens, and is intended to provide a sense of participation in the energy system. Ultimately, the Energy Box may also enable the citizens to participate in energy markets.

Dochev et al. take a starting point in the need for heat demand data in their article *Spatial aggregation and visualisation of urban heat demand using graph theory* [30]. While many municipalities in Germany are actively developing such heat maps, there are also potential privacy issues. In their work, the authors seek to transcend this complication by aggregating data using an algorithm based on graph theory. This article adds to the considerable body of literature on spatial data on heat demands [31], electricity demands [32], and energy sources [33–36] from the IJSEPM.

4. Tools and theories for transition

Miguel-Herrero et al. focus on the circumstance that data is a prerequisite for doing good local energy planning. In *Supporting tool for multi-scale energetic plan through procedures of data enrichment* [37], the authors focus on generating typologies of houses which can be used in the wider assessment of energy demands needs using geographical information tools. In this way, the authors expand on the knowledge already presented in the IJSEPM by authors like Grundahl and Nielsen [38] and Knies [39].

In *Decision Support System for smart urban management: resilience against natural phenomena and aerial environmental assessment* [40], Taraglio et al. present a new decision support system focusing on risk analysis including assessment of the consequences of events on citizens and more

Taking the case of Zero Energy Bergen as a starting point, Gohari & Larssæther investigate the governance structure surrounding the energy transition in the

article *Sustainable energy planning as a co-creative governance challenge. Lessons from the zero village Bergen* [41]. The character of the transition transcends current governance structures, thus the authors seek to develop a new theoretical understanding of the political and institutional challenges at hand.

Meloni et al. show how local governance must be strengthened in the article *Energy sustainability and social empowerment: the case of Centocelle smart community co-creation* [42]. However, innovation processes and participation are focused on in their analyses, showing how these may contribute to the transition. Based on the Centocelle district in Rome, their work shows how such elements can form part of a governance structure. This is in line with how previous work from the IJSEPM has indicated a need for appropriate governance structures [43].

Acknowledgements

The article presents work published in the IJSEPM EERA Joint Programme on Smart Cities special issue. The authors of this paper / editors of this special issue would like to thank all the reviewers who have assisted in making the contributing authors' work suitable for publication in this special issue.

References

- [1] Losasso M. Introduction. *Techne* 2018;5–5. <http://doi.org/10.13128/Techne-23559>.
- [2] Maestosi PC. Foreword. *Techne* 2018. <http://doi.org/10.13128/Techne-23560>.
- [3] Østergaard PA, Sperling K. Towards Sustainable Energy Planning and Management. *Int J Sustain Energy Plan Manag* 2014;1:1–5. <http://doi.org/10.5278/ijsepm.2014.1.1>.
- [4] Bačekočić I, Østergaard PA. A smart energy system approach vs a non-integrated renewable energy system approach to designing a future energy system in Zagreb. *Energy* 2018;155. <http://doi.org/10.1016/j.energy.2018.05.075>.
- [5] Lund H, Andersen AN, Østergaard PA, Mathiesen BV, Connolly D. From electricity smart grids to smart energy systems - A market operation based approach and understanding. *Energy* 2012;42:96–102. <http://doi.org/10.1016/j.energy.2012.04.003>.
- [6] Mathiesen BV, Lund H, Connolly D, Wenzel H, Østergaard PA, Möller B, et al. Smart Energy Systems for coherent 100% renewable energy and transport solutions. *Appl Energy* 2015;145:139–54. <http://doi.org/10.1016/j.apenergy.2015.01.075>.
- [7] Lund H, Østergaard PA, Connolly D, Ridjan I, Mathiesen BV, Hvelplund F, et al. Energy storage and smart energy systems. *Int J Sustain Energy Plan Manag* 2016;11:3–14. <http://doi.org/10.5278/ijsepm.2016.11.2>.
- [8] Maestosi PC, Civiero P, Massa G. European Union funding Research Development and Innovation projects on Smart Cities: the state of the art in 2019. *Int J Sustain Energy Plan Manag* 2019;24. <http://doi.org/10.5278/ijsepm.3493>.
- [9] Maestosi PC. Point of view. Dialogues: A virtual round table. *Int J Sustain Energy Plan Manag* 2019;24. <http://doi.org/10.5278/ijsepm.3502>.
- [10] Ben Amer S, Bramstoft R, Balyk O, Nielsen PS. Modelling the future low-carbon energy systems - a case study of Greater Copenhagen, Denmark. *Int J Sustain Energy Plan Manag* 2019;24. <http://doi.org/10.5278/ijsepm.3356>.
- [11] Trømborg E, Havskjold M, Bolkesjø TF, Kirkerud JG, Tveten ÅG. Flexible use of electricity in heat-only district heating plants. *Int J Sustain Energy Plan Manag* 2017;12:29–46. <http://doi.org/10.5278/ijsepm.2017.12.4>.
- [12] Tveten ÅG, Bolkesjø TF, Ilieva I. Increased demand-side flexibility: market effects and impacts on variable renewable energy integration. *Int J Sustain Energy Plan Manag* 2016;11:33–50. <http://doi.org/10.5278/ijsepm.2016.11.4>.
- [13] Ancona MA, Bianchi M, Branchini L, De Pascale A, Melino F, Peretto A. Low temperature district heating networks for complete energy needs fulfillment. *Int J Sustain Energy Plan Manag* 2019;24. <http://doi.org/10.5278/ijsepm.3340>.
- [14] Lund R, Østergaard DS, Yang X, Mathiesen BV. Comparison of Low-temperature District Heating Concepts in a Long-Term Energy System Perspective. *Int J Sustain Energy Plan Manag* 2017;12:5–18. <http://doi.org/10.5278/ijsepm.2017.12.2>.
- [15] Ianakiev AI, Cui JM, Garbett S, Filer A. Innovative system for delivery of low temperature district heating. *Int J Sustain Energy Plan Manag* 2017;12:19–28. <http://doi.org/10.5278/ijsepm.2017.12.3>.
- [16] Best I, Orozaliev J, Vajen K. Economic comparison of low-temperature and ultra-low-temperature district heating for new building developments with low heat demand densities in Germany. *Int J Sustain Energy Plan Manag* 2018;16. <http://doi.org/10.5278/ijsepm.2018.16.4>.
- [17] Widzinski M. Simulation of an alternative energy system for district heating company in the light of changes in regulations of the emission of harmful substances into the atmosphere. *Int J Sustain Energy Plan Manag* 2019;24. <http://doi.org/10.5278/ijsepm.3354>.
- [18] Sneum DM, Sandberg E. Economic incentives for flexible district heating in the Nordic countries. *Int J Sustain Energy Plan Manag* 2018;16. <http://doi.org/10.5278/ijsepm.2018.16.3>.

- [19] Sorknæs P, Lund H, Andersen AN, Ritter P. Small-scale combined heat and power as a balancing reserve for wind – the case of participation in the German secondary control reserve. *Int J Sustain Energy Plan Manag* 2014;4. <http://doi.org/10.5278/ijsepm.2014.4.4>.
- [20] Prina MG, Cozzini M, Garegnani G, Moser D, Oberegger UF, Vaccaro R, et al. Smart energy systems applied at urban level: the case of the municipality of Bressanone-Brixen. *Int J Sustain Energy Plan Manag* 2016;10:33–52. <http://doi.org/10.5278/ijsepm.2016.10.4>.
- [21] Lund H, Thellufsen JZ, Aggerholm S, Wichtten KB, Nielsen S, Mathiesen BV, et al. Heat Saving Strategies in Sustainable Smart Energy Systems. *Int J Sustain Energy Plan Manag* 2014;04:3–16. <http://doi.org/10.5278/ijsepm.2014.4.2>.
- [22] Østergaard PA, Lund H. Smart district heating and electrification. *Int J Sustain Energy Plan Manag* 2017;12. <http://doi.org/10.5278/ijsepm.2017.12.1>.
- [23] Østergaard PA, Lund H, Mathiesen BV. Smart energy systems and 4th generation district heating. *Int J Sustain Energy Plan Manag* 2016;10:1–2. <http://doi.org/10.5278/ijsepm.2016.10.1>.
- [24] Tötzer T, Stollnberger R, Krebs R, Haas M. How can Urban Manufacturing contribute to a more sustainable energy system in cities? *Int J Sustain Energy Plan Manag* 2019;24. <http://doi.org/10.5278/ijsepm.3347>.
- [25] Jaroszewska M, Chaja P, Dziadkiewicz A. Sustainable energy management: are tourism SMEs in the South Baltic region ready? *Int J Sustain Energy Plan Manag* 2019;24. <http://doi.org/10.5278/ijsepm.3342>.
- [26] Bose A, Ahmad MS, Kuzeva DD, van Kasteren J. Techno-Economic Design and Social Integration of Mobile Thermal Energy Storage (M-TES) within the Tourism Industry. *Int J Sustain Energy Plan Manag* 2019;22. <http://doi.org/10.5278/ijsepm.2544>.
- [27] Cassinadri E, Gambarini E, Nocerino R, Scopelliti L. Sharing Cities: from vision to reality. A people, place and platform approach to implement Milan's Smart City strategy. *Int J Sustain Energy Plan Manag* 2019;24. <http://doi.org/10.5278/ijsepm.3336>.
- [28] Cellurale M, Clemente C, Maestosi PC, Ciciero P. Solutions and services for smart sustainable district: an innovative approach in Key Performance Indicators to support transition. *Int J Sustain Energy Plan Manag* 2019;24. <http://doi.org/10.5278/ijsepm.3350>.
- [29] Romano S. Experimental demonstration of a smart homes network in Rome. *Int J Sustain Energy Plan Manag* 2019;24. <http://doi.org/10.5278/ijsepm.3335>.
- [30] Dochev I, Seller H, Peters I. Spatial aggregation and visualisation of urban heat demand using graph theory. *Int J Sustain Energy Plan Manag* 2019;24. <http://doi.org/10.5278/ijsepm.3346>.
- [31] Möller B, Nielsen S. High resolution heat atlases for demand and supply mapping. *Int J Sustain Energy Plan Manag* 2014;1:41–58.
- [32] Hülk L, Wienholt L, Cußmann I, Müller UP, Matke C, Kötter E. Allocation of annual electricity consumption and power generation capacities across multiple voltage levels in a high spatial resolution. *Int J Sustain Energy Plan Manag* 2017;13. <http://doi.org/10.5278/ijsepm.2017.13.6>.
- [33] Quiquerez L, Faessler J, Lachal B, Mermoud F, Hollmuller P. GIS methodology and case study regarding assessment of the solar potential at territorial level: PV or thermal? *Int J Sustain Energy Plan Manag* 2015;6:3–16. <http://doi.org/10.5278/ijsepm.2015.6.2>.
- [34] Mukherjee D, Cromley R, Shah F, Bravo-Ureta B. Optimal location of centralized biodigesters for small dairy farms: A case study from the United States. *Int J Sustain Energy Plan Manag* 2015;8:3–16. <http://doi.org/10.5278/ijsepm.2015.8.2>.
- [35] Oloo F, Olang L, Strobl J. Spatial Modelling of Solar energy Potential in Kenya. *Int J Sustain Energy Plan Manag* 2015;6:17–30. <http://doi.org/10.5278/ijsepm.2015.6.3>.
- [36] Korfiati A, Gkonos C, Veronesi F, Gak A, Grassi S, Schenkel R, et al. Estimation of the Global Solar Energy Potential and Photovoltaic Cost with the use of Open Data. *Int J Sustain Energy Plan Manag* 2016;9:Start-End. <http://doi.org/10.5278/ijsepm.2016.9.3>.
- [37] Miguel FJ, Hernández-Moral G, Serna-González VI. Supporting tool for multi-scale energetic plan through procedures of data enrichment. *Int J Sustain Energy Plan Manag* 2019;24. <http://doi.org/10.5278/ijsepm.3345>.
- [38] Grundahl L, Nielsen S. Heat atlas accuracy compared to metered data. *Int J Sustain Energy Plan Manag* 2019;23. <http://doi.org/10.5278/ijsepm.3174>.
- [39] Knies J. A spatial approach for future-oriented heat planning in urban areas. *Int J Sustain Energy Plan Manag* 2018. <http://doi.org/10.5278/ijsepm.2018.16.2>.
- [40] Taraglio S, Chiesa S, La Porta L, Pollino M, Verdecchia M, Tomassetti B, et al. Decision Support System for smart urban management: resilience against natural phenomena and aerial environmental assessment. *Int J Sustain Energy Plan Manag* 2019;24. <http://doi.org/10.5278/ijsepm.3338>.
- [41] Gohari S, Larssæther S. Sustainable energy planning as a co-creative governance challenge. Lessons from the zero village Bergen. *Int J Sustain Energy Plan Manag* 2019;24. <http://doi.org/10.5278/ijsepm.3353>.
- [42] Meloni C, Cappellaro F, Chiarini R, Snels C. Energy sustainability and social empowerment: the case of Centocelle smart community co-creation. *Int J Sustain Energy Plan Manag* 2019;24. <http://doi.org/10.5278/ijsepm.3339>.
- [43] Selvakkumaran S, Ahlgren E. Understanding the local energy transitions process: a systematic review. *Int J Sustain Energy Plan Manag* 2017;14:x-y. <http://doi.org/10.5278/ijsepm.2017.14.5>.

International Journal of Sustainable Energy Planning and Management

OPENING

European Union funding Research Development and Innovation projects on Smart Cities: the state of the art in 2019

Paola Clerici Maestosi^{a*}, Paolo Civiero^b and Gilda Massa^c

^a ENEA Italian National Agency for New Technologies, Energy and Sustainable Economic Development – Energy Technologies Department, Via Martiri di Monte Sole, 4, 40129 Bologna, Italy

^b IREC Catalonia Institute for Energy Research, Jardins de les Dones de Negre, 1, 08930 Sant Adrià de Besòs, Barcelona, Spain

^c ENEA Italian National Agency for New Technologies, Energy and Sustainable Economic Development – Energy Technologies Department, Piazzale Enrico Fermi, 1, 80055 Portici NA, Italy

ABSTRACT

European cities currently host 72% of the European population, which probably will rise to 80% by 2050.

European Union, Member States, National and Regions Authorities and different type of stakeholders have worked – and keep on doing – together to promote a sustainable urban development and to adapt policies to the needs of cities, thus make visible improvements to the daily lives of people.

According to this approach, many Member States decided to pool resources at European level, achieving more than by acting alone. It is thanks to the coordinated approach of European Union and Member State that Research Development & Innovation boost smart cities and smart specialization strategies as two novelties that have been adopted by policymakers.

Keywords:

Cities in EU policy;
Budget for smart cities;
Demonstration projects;
Positive Energy Districts;

URL: <http://doi.org/10.5278/ijsepm.3493>

1. The Smart City concept

Cities and urban areas have been a key issue in EU/ Member State policies and programs, in the light of the fact that over two thirds of the European population live in urban areas and that cities were and will be places where both problems emerge and solutions are found, places which are fertile ground for growth of science and technology, to stimulate culture and innovation, to support individual and collective creativity and where, more than elsewhere, climate change mitigation can be more easily understood. Cities play a crucial role as engines of the economy, places of connectivity, creativity and innovation, as well as centers of services for the surrounding areas. Therefore, cities represent a high

priority for the effective implementation of Europe itself.

Although European cities play a key role in the life of Europeans, it seems almost incongruent and senseless that there is no common definition for “urban” or even for “city”, and that the European Union has no explicit jurisdiction in urban development, as urban planning per se is not a European policy competence even if economic, social and territorial cohesion all have a strong urban dimension. Therefore, even if the “European model of the city” is a fascinating issue, it is clear that there is no need to adopt a single definition. However, it is possible to move towards a shared European vision of urban development, as noted by the paper “Cities of Tomorrow” (DG Regional Policy, 2011) which consider

*Corresponding author e-mail: paola.clerici@enea.it

Acronyms and Abbreviations

DG: Directorate General
EIP: European Industrial Partnership
ERDF: European Regional Development Fund
ESIF: European Structural and Investment Funds
EU: European Union;
H2020 Framework: Horizon 2020 Framework
KPIs: Key Performance Indicators
ICT: information and Communication Technologies

PED/PEN: Positive Energy Districts/Positive Energy Neighborhoods
RD&I: research, Development & Innovation
SCC: Smart Cities and Communities
SDGs: Sustainable Development Goals
SME: Small and medium Enterprise
SUD: Smart Urban Districts

that “there is not a single vision of the European city model but there might be as many visions as there are Europeans. These visions are diverse as they build on different realities, different strengths, weaknesses, opportunities and threats as well as different values”.

This means that Europe can play a role in defining and setting up of the framework and providing guiding principles for the growth of a shared vision of European cities, in which the dimension of a sustainable urban development is taken into account in an integrated way. In general terms, this is what took place with European funding in RD&I: even if EC has no explicit competence in urban development and policies Research Development & Innovation programs have undoubtedly contributed to promote and support a shared European vision for smart cities.

Many of these programs have become EU trademarks and trade names, making the EU visible and recognizable in the daily lives of its citizens.

The idea behind this shared vision is that European cities aspire to be places of green, ecological and environmental regeneration as well as places of advanced social progress, platforms for democracy, cultural dialogue and diversity.

Since 2007 discussions, workshops, white papers, DoW (documents of Work) have been written, created and developed about the future of cities, both at national and European level, as well as glossaries have been prepared according to the idea that in the transition from industrial to knowledge-based societies, the cities in the world are changing their shapes. As a result, new definitions were created such as: healthy citiesⁱ,

ⁱ Cities that, according to WHO, are continually creating and improving physical and social environments and expanding community resources. These efforts enable citizens to mutually support each other in performing all functions of life and developing to their maximum potential. For an increasing number of cities, the healthy city model is seen as particularly valuable because it attracts resourceful citizens; Huset Mandag Morgen, special edition on Futures of cities, may 2007, DK

slow citiesⁱⁱ, slum citiesⁱⁱⁱ, community cities^{iv}, shrinking cities^v, second cities^{vi}, historical cities^{vii},

ⁱⁱ Cities that respond to the high pulse of the modern metropolis by launching concepts that slow down the pace. These will typically be cities whose layout and amenities support a lifestyle that prioritises recreational activity, the possibility of relaxing and enjoying life. A number of these cities have joined the “Slow City Movement” inaugurated in 1999 in the Italian city of Orvieto. The original incentive for this movement was “slow food”, the wish to increase the knowledge about and demand for this type of cuisine; Huset Mandag Morgen, special edition on Futures of cities, may 2007, DK

ⁱⁱⁱ Cities that are affected by great poverty. Such cities will typically have districts where the poorest citizens live in miserable conditions with no access to adequate health services, medical and social help, education, work, etc. These harsh conditions often make these districts appear as a threat to their surroundings: the environing communities typically react by sealing themselves off from the slum district, Huset Mandag Morgen, special edition on Futures of cities, may 2007, DK

^{iv} Cities where citizens experience a special community feeling and interact closely with other people in their neighborhood. These cities create and maintain local values and ensure a sense of security for the individual citizen. They are characterized by strong cohesion that is defined by the citizens’ shared values and local attachment rather than by the functions the city is expected to fulfil; Huset Mandag Morgen, special edition on Futures of cities, may 2007, DK

^v Cities that are getting smaller in size, thus contradicting global urbanization trends. The decrease in size is often a consequence of a drop in birth rates and/or the closing of larger industrial workplaces that have contributed significantly to the growth of the cities. Many shrinking cities make dedicated efforts to adjust to the demands of the knowledge society, in which the ability to generate growth does not necessarily depends on size; Huset Mandag Morgen, special edition on Futures of cities, may 2007, DK

^{vi} Cities that stand in the shadow of the most important city in a given country or region. The definition “second city” is increasingly used about cities that have defied their status as “provincial” in recent years, and have managed to assert themselves in the competition for resources and growth, in some regions and countries, the strong first cities feel overtaken and intimidated because the combination of smaller size and independence make second cities move faster than their larger counterparts; Huset Mandag Morgen, special edition on Futures of cities, may 2007, DK

^{vii} Cities that have made significant historic contributions to urban development. This definition is typically used for cities listed on the UN’s World Heritage List. It is also used to define cities that have historic sites, buildings, landmarks, etc. that have contributed to significant events in the world history, hereby profiling the city to the outside world. The primary challenge for cities in this category is to retain their historic distinction while still meeting the needs of modern citizens; Huset Mandag Morgen, special edition on Futures of cities, may 2007, DK

and then green cities^{viii}, and - last but not least - quality-of-life cities^{ix}.

Besides all these one has started to prevail: the Smart City paradigm. Maybe because as a huge amount of funding - national, international and EC - has been dedicated to this topic, due to the large number of stakeholders that could be catalyzed in the design, scaling up and replicability of the smart city itself.

It is matter of fact that the definitions of Smart Cities have changed over the years based on aims and goals of different proponents, stakeholders and supporters but, the last definition that have been proposed by EIP in Smart Cities and Communities – Strategic and Implementation Plan, is probably the one which is better to mention here: “Smart cities should be regarded as systems of people interacting with and using flows of energy, materials, services and financing to catalyze sustainable economic development, resilience and high quality of life; these flows and interactions become smart through making strategic use of information and communication infrastructure and services in a process of transparent urban planning and management that is responsive to the social and economic needs of society”.

2. Smart Cities and Smart Cities related topic: state of the art in 2019

2.1. Numbers within the Smart Cities and Smart Cities related projects

Today Europe capitalize on over 30 years of investment in transnational Research and Innovation programmes on sustainable urban development. European Union budget has - indeed - contributed to deploy solutions on the “*things that matter*” for Europeans such as urban areas, which have been a key issue in European Community funding programmes.

^{viii} Cities that are based on a mindset of sustainability and energy-efficient solutions with a view to reducing CO₂ emission and bringing down the consumption of energy resources. This is seen in different ways, for instance by having a well-functioning public infrastructure that ensures minimal use of cars in the city, and dense building with defined standards for building materials, design, etc. that are as environmentally friendly as possible; Huset Mandag Morgen, special edition on Futures of cities, may 2007, DK

^{ix} Cities whose primary purpose is to ensure a high quality of life for their citizens. Their efforts range from high health standards to local initiatives that ensure a dignified life for all citizens. The latter is achieved by providing sufficient opportunities for education and work. It requires a balance between public and individual needs. Through their organization and physical layout, these cities wish to guarantee safety and security while ensuring that the individual citizen feels free and content as a member of a larger community; Huset Mandag Morgen, special edition on Futures of cities, may 2007, DK

In the last five years the EC promoted Research Development & Innovation on urban issues providing support through a wide range of funding programs - covering different funding opportunities according to main pillars in H2020 Framework, namely Excellence in Science, Industrial Leadership and Societal Challenges with following distribution [Figure 1]:

- 16 projects under program H2020-EU.3.3.1.3. - Foster European Smart cities and Communities;
- 2 project under program H2020-EU3.3 Societal Challenges - Secure, clean and efficient energy;
- 9 projects under program H2020-EU.2.1.1 Industrial Leadership - leadership in enabling and industrial technologies - Information and Communication technologies (ICT)
- 2 projects under program H2020-EU.2.1.1.7. – ECSEL
- 1 project under the Program H2020-EU.3.4.8.1. - Innovation Program 1 (IP1): Cost-efficient and reliable trains
- 2 project under program H2020-EU.3.4.8.3. - Innovation Program 3: Cost Efficient and Reliable High Capacity Infrastructure
- 1 project under Program H2020-EU.3.4.8.4. - Innovation Programme 4: IT Solutions for attractive railway services
- 1 project under Program H2020-EU.3.3.4. - A single, smart European electricity grid
- 1 project under Program H2020-EU.1.2.2. - FET Proactive
- 2 project under Program H2020-EU.3.3.7. - Market uptake of energy innovation - building on Intelligent Energy Europe

The overall budget related to H2020-EU.3.3.1.3. - Foster European Smart cities and Communities has been 357,675,069.34 with EU contribution for 302,892,122.37, while the overall budget related to the other cited programs has been €133.854.886,79 with EU contribution for €14.112.165,98 [Figure 2]. This data clearly states that if we refer to Smart Cities we automatically refers to H2020 – Foster European Smart Cities and Communities but, even if the amount of additional funded projects related to Smart Cities in different calls is less than the ones in H2020-EU.3.3.1.3., have been funded the same quantity of projects, which means the appealing of smart cities related topics.

Then, if we refer to the type of funded projects it is easy to see that:

37 projects funded cover all the projects type spectrum, as we have 59% of Innovation Actions; 19% of

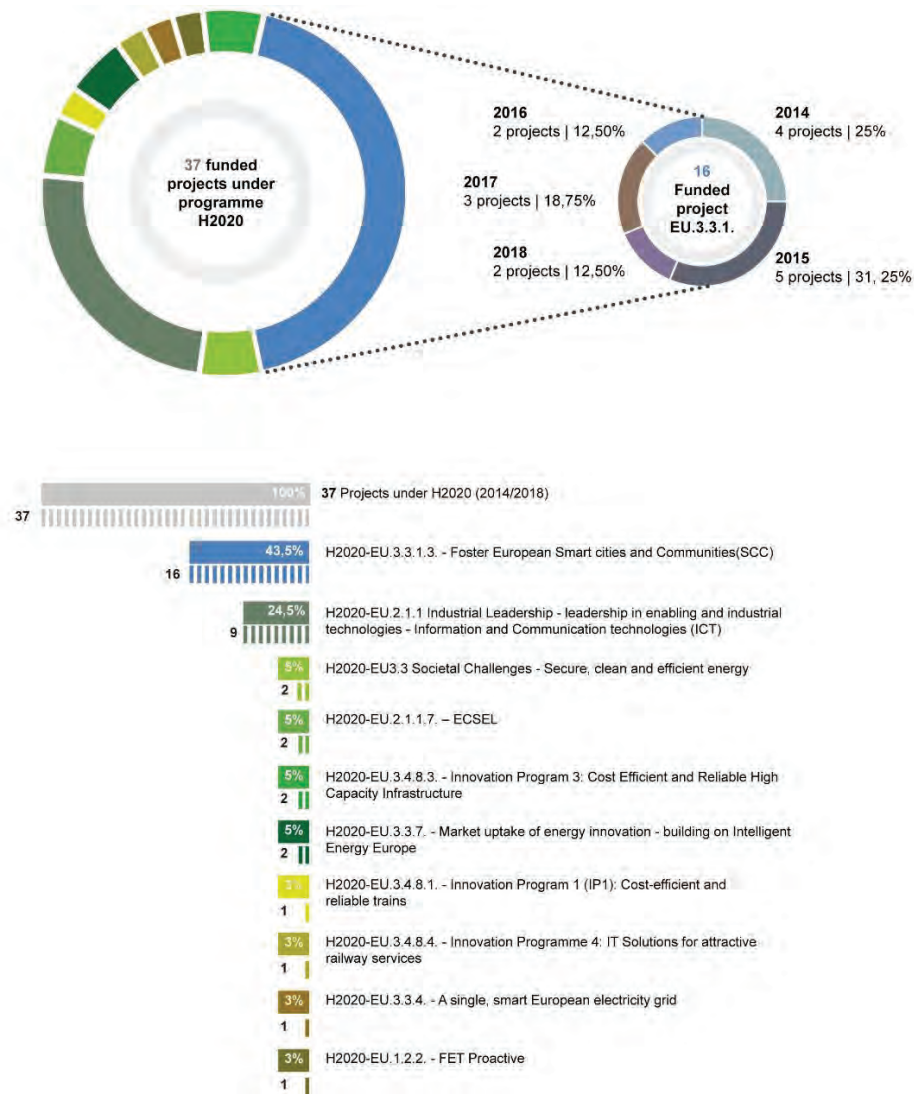

Figure 1: Smart Cities/Smart Cities related topics: project funded in H2020 (image elaborated by authors on a set of data source period 2014–2018 (end) [1,2,3])

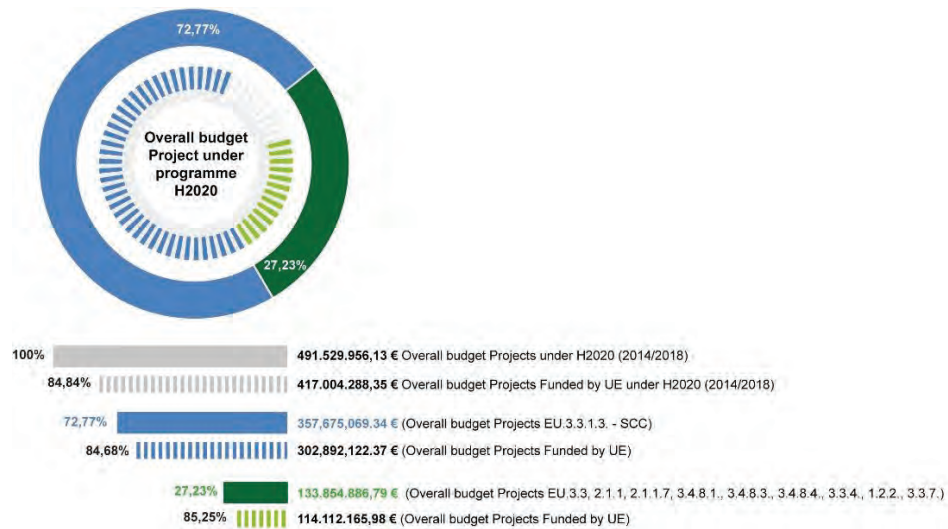

Figure 2: Smart Cities/Smart Cities related topics: overall budget funded in H2020 (image elaborated by authors on a set of data source period 2014–2018 (end) [1,2,3])

Research and Innovation Actions; 16% of Coordination and support action; 2% of Feasibility studies

Looking at project dimension the Innovation actions have received a funding of €380.081.613,52, the Research and Innovation stands at €30.218.711,83, whilst Coordination and Support Actions together with feasibility studies request an amount of €6.801.051,25 [Figure 3].

This is a clear indicator of the high Technology Redness Level of these project and how near they are to the market uptake.

It is also important to stress the fact that in the period 2014–2020 the urban dimension has been put at the very heart of EC Cohesion Policy, too.

Thanks to European Regional Development Fund (ERDF) and European Structural and Investment Funds (ESIF) Member States funded thematic objectives programmes with a strong focus on 4 key priority areas (Research and Innovation, Digital Economy, SME Competitiveness and Low Carbon Economy took place); so overall budget estimated for the period 2014-2020 has been €278,942,793,261.00 with an investment on topic related to sustainable urban development such as ICT, renewable energy and energy efficiency of €2,388,082,326.00. [3]

Thus European Union stimulated, in various and different ways, cities to be actors of Open Innovation in responding to the present environmental, social and economic challenges.

European Union, Member States, National and Regions Authorities and different type of stakeholders have worked - and keep on doing - together to promote a sustainable urban development and to adapt policies to

the needs of cities, thus make visible improvements to the daily lives of people.

As highlighted in EERA JPSC special issue 1|2018 Towards and European vision for the Smart Cities to come “According to this approach, many Member States pooled resources at European level, achieving more than by acting alone. Therefore, together with national budgets and a wide range of legislative and regulatory instruments, the EU budget has allowed to support shared objectives and tackle common challenges including CO₂ reduction in urban areas and a carbon-neutral economy thorough initiatives aimed at implementing the so-called ‘smart cities’. It is thanks to the coordinated EU/Member State approach that RD&I boost smart cities and smart specialization strategies as two novelties that have been quickly adopted by policymakers, then translated into specific policies and initiatives that were mainstreamed into regional policies.”

The EU Research and Innovation policy has been supported - and still it is - by Horizon 2020 Framework Programme, the main instrument in which new research and innovation on sustainable urban development has been designed. The main policy goals have been to spur novel solutions and partnerships to urban challenges and to create an open community of practice.

Thus, Horizon 2020 supported different solution-oriented initiatives to respond to the complexity of Societal Challenges related to cities and urban areas, indeed.

Multiple large scale demonstration projects were launched in the framework of the cross-cutting Focus Area on ‘Smart and Sustainable Cities’, which called for

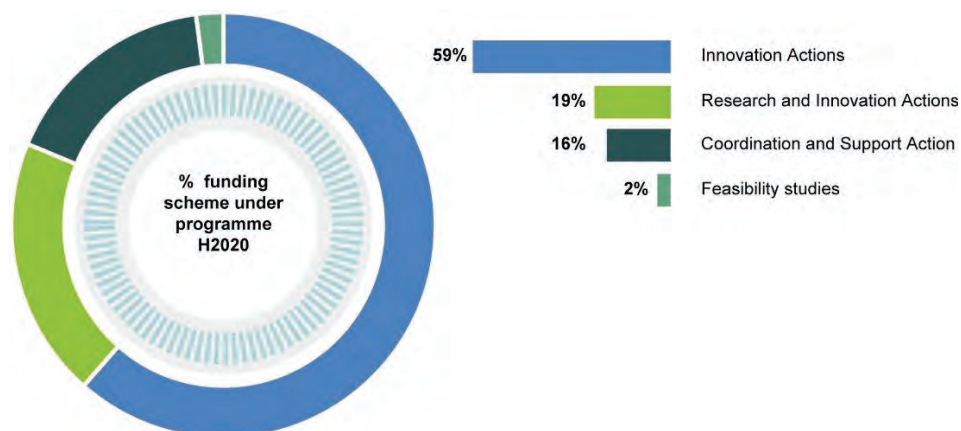

Figure 3: Smart Cities/Smart Cities related topics: type of actions funded in H2020 (image elaborated by authors on a set of data source period 2014–2018 (end) [1,2,3])

a systemic approach to stimulate sustainable urban development, in which cities act as living labs to create an open innovation ecosystem. “Frontrunner” cities develop and test innovative solutions. These solutions are deployed at a wider scale through peer-learning with dedicated “Follower” cities.

The most of these multiple large scale demonstration projects – supported by H2020 lighthouse call (SCC-2014/2018) are still ongoing (data referred to end 2018) while just CITYKEYS and ESPRESSO have been completed.

Nerveless, some interesting considerations follows:

- 38 cities have been or still are working as Lighthouse SCC pilot cities (Antalya, Bristol, Dresden, Eindhoven, Firenze, Glasgow, Goteborg, Groningen, Hamburg, Helsinki, Leeds, Limerick, Lisbon, London, Lyon, Manchester,

Milano, Munich, Nantes, Nice, Nottingham, Oulu, Pamplona, Rotterdam, San Sebastian, Sondeborg, Stavanger, Tampere, Tartu, Tepebasi/Eskisehir, Trento, Trondheim, Umea, Utrecht, Valencia, Valladolid, Vienna, Vitoria/Gasteiz), while 30 as Lighthouse SCC follower cities (Asenovgrad, Bordeaux, Brno, Burgas, Bydgoszcz, Cluj-Napoca, Derry, Essen, Gdansk, Herzliya, Kerava, Kozani, Lousanne, Lecce, Leipzig, Litomerice, Miskolc, Nilufer, Ostend, Palencia, Parma, Prague, Rijeka, Sabadell, Santiago de Compostela, Seraing, Skopje, Sofia, Venezia, Warsaw) [Figure 4];

- Project leader in Lighthouse SCC are located in Spain (7), Netherlands and UK (2), Finland, France, Germany, Norway and Sweden (1) [Figure 5];

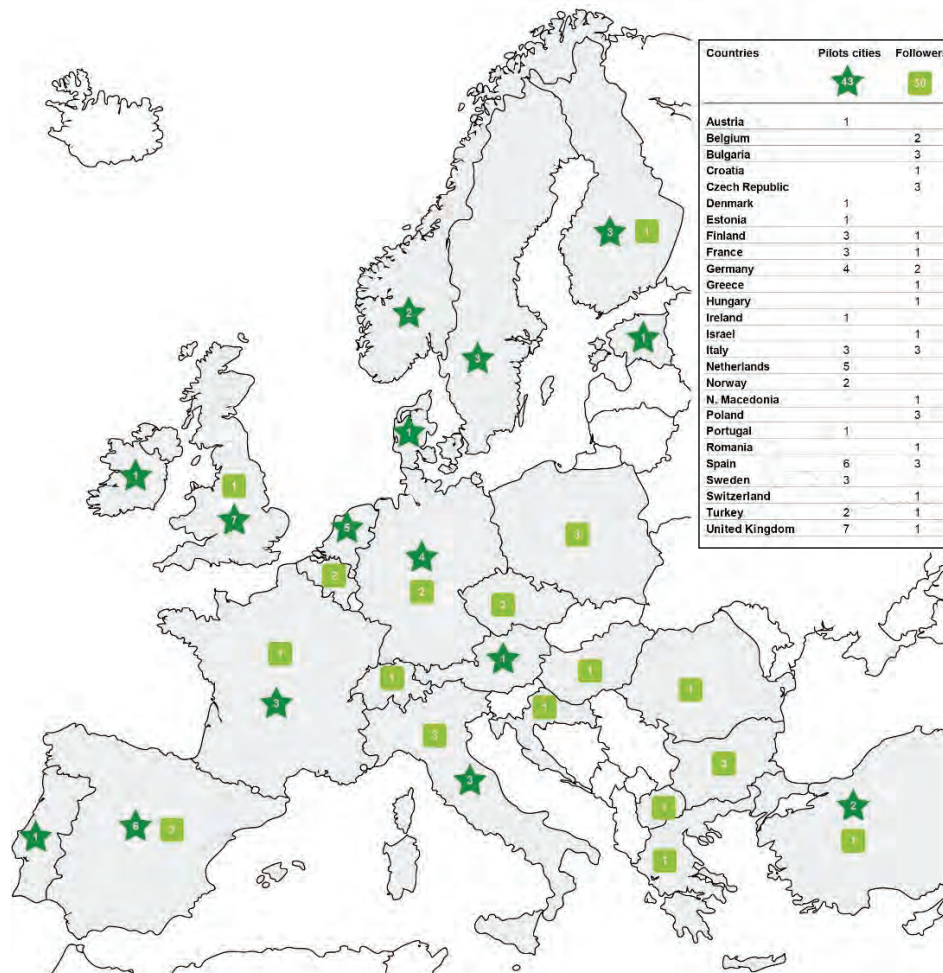

Figure 4: Pilot Cities/Follower Cities in Lighthouse SCC H2020 (image elaborated by authors on a set of data source period 2014–2018 (end) [1,2,3])

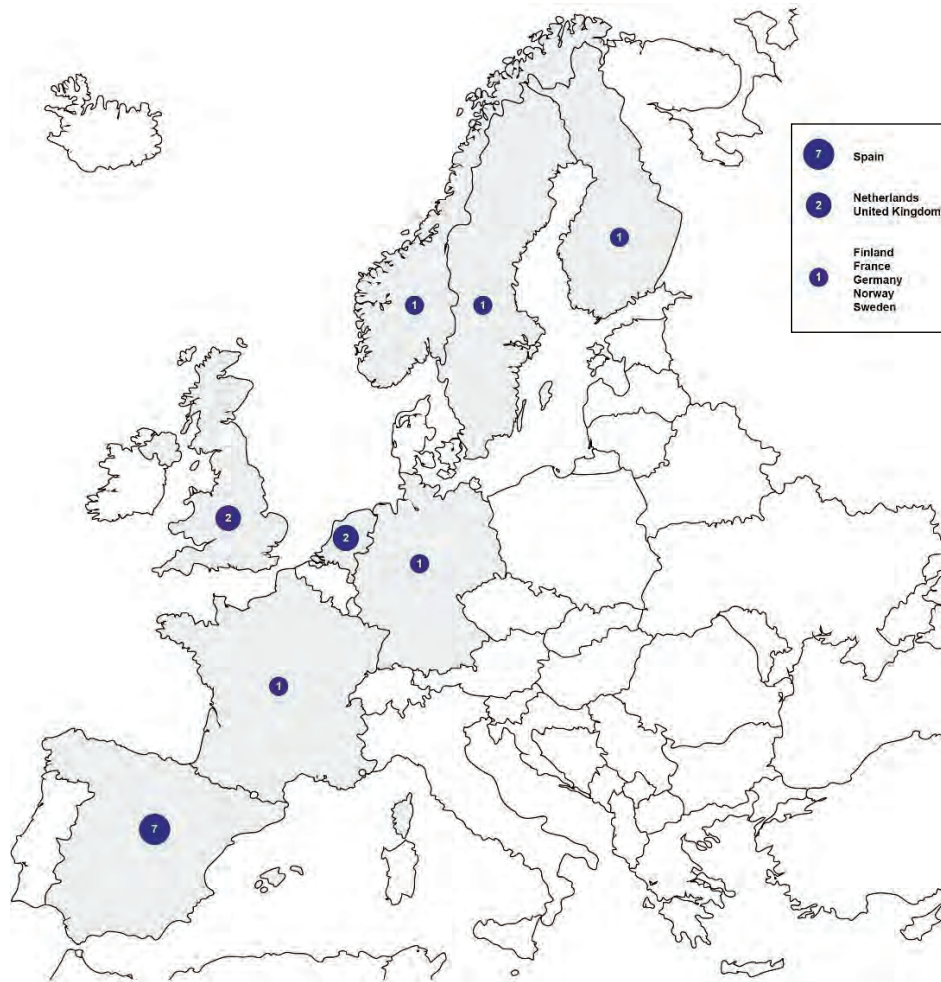

Figure 5: Project leader distribution in Lighthouse SCC H2020 (image elaborated by authors on a set of data source period 2014–2018 (end) [1,2,3])

- countries participation per projects in Lighthouse SCC is subdivided in Spain (14), Germany and Italy (11), Belgium (8), France Netherlands and UK (7), Bulgaria and Finland (6), Austria, Czech, Poland, Romania, Turkey (4), Denmark, Estonia, Greece, Sweden (3), Croatia, Hungary, Ireland, Norway, Portugal, Switzerland (2), North Macedonia, Israel, Malta, Slovakia (1) [Figure 6];
- participants stakeholders within the country ranks: Spain (88), Germany (48), UK (44), Italy (43), Netherlands (39), France (31), Sweden (29), Finland (28), Norway (16), Turkey (15), Austria (12), Estonia (11), Ireland and Denmark (10), Portugal, Bulgaria and Belgium (9), Poland (7), Romania (6), Greece and Czech (5), Switzerland, Slovakia, Hungary, Croatia (2), Malta, North Macedonia and Israel (1) [Figure 7].

If we consider that is highly desirable, for testing the coverage of Smart Cities concepts in Member State, the participation of Municipalities not only as Lighthouse Cities but also as Follower Cities, we discover that only few Member States (Finland, France, Germany, Italy, Spain, Turkey and United Kingdom) are well positioned; thus this could be indicative of a sort of implicit national roadmap supporting the experimentation and replication of Smart Cities concept. Another surprising data refers to the fact that there is not a direct correspondence among being a Lighthouse Cities and promoting the involvement of may stakeholders. If we refer to the Italian situation we will see that even if there are not Italian lighthouse cities, the number of stakeholders participating in lighthouse projects is significantly high. This again demonstrate how much pervasive the Smart Cities concept has been at a national level.

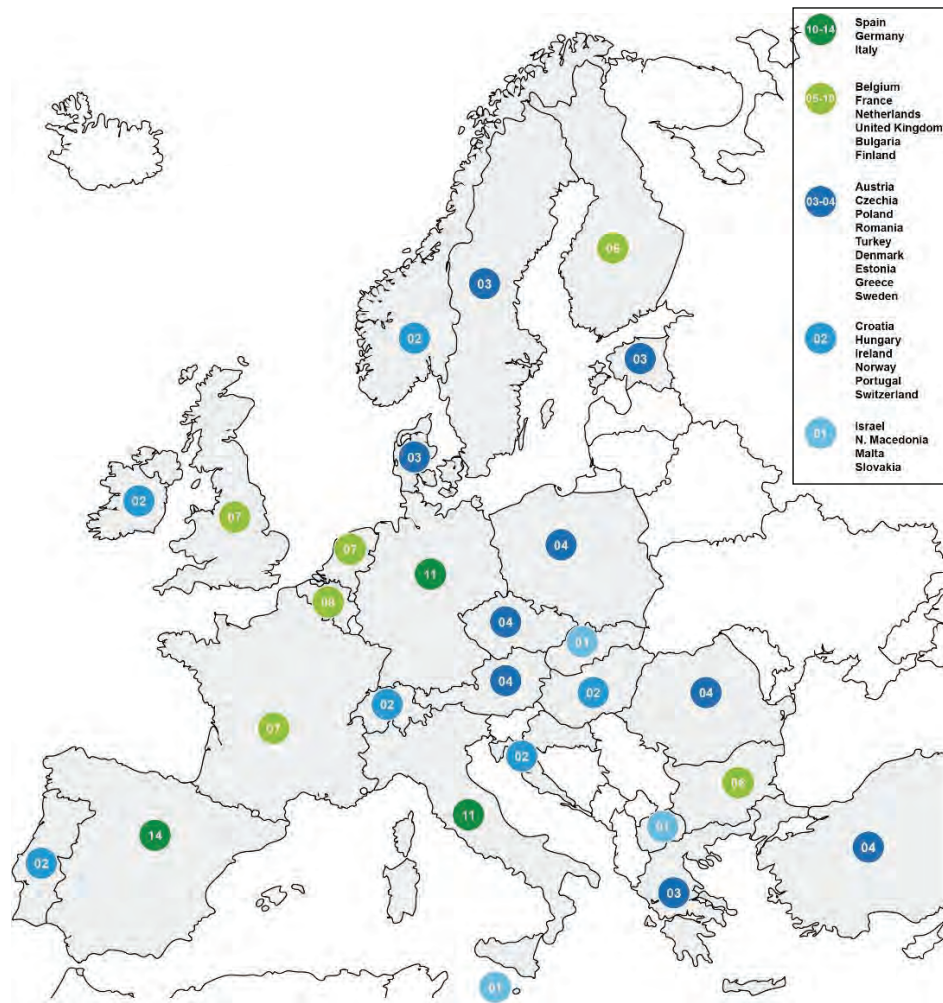

Figure 6: Countries participation in H2020 (image elaborated by authors on a set of data source period 2014–2018 (end) [1,2,3])

Then if we refer to Smart Cities related topics projects we highlight that we have 367 European partners while the biggest project SinchroniCity involves partners even from Mexico, South Korea and Switzerland with, as clear, no EU contribution.

Looking at data collected we can see that:

- Project leader are located in Spain (4), Germany, UK, Belgium, (2), Austria, Greece, Eire, Italy, Portugal, Denmark, Slovenia (1) [Figure 8];
- countries participation is Spain (71), Germany (49), Italy (36), France (28), Austria (24) UK (22), Greece (16), Belgium and Portugal (14), Switzerland (10), Ireland (8), Norway, Sweden and Slovenia (6), Czechia (5), Denmark and Mexico (4), Luxemburg, South Korea and Serbia (3), Turkey, Israele, Croazia, Bosnia and Herzegovina (2), Poland, Slovakia and Lituania (1) [Figure 9];

According to the data exposed we can express following consideration:

- Smart Cities related topics projects have involved 36 States: 2 extra Europe (Mexico and South Korea) and Switzerland, plus 33 among Member States and Observers.
- top five countries per participation in Smart Cities related project are Spain 19%, Germany 11%, Italy 9%, UK 8% and France 7% [Figure 10]

2.2. Topics within the Smart Cities and Smart Cities related projects

Smart Cities and Smart Cities related projects funded by H2020 lighthouse call (SCC-2014/2018) are focused on specific topics such as:

- Energy Efficiency in Buildings – among which the most successful topics has been Building Integrated

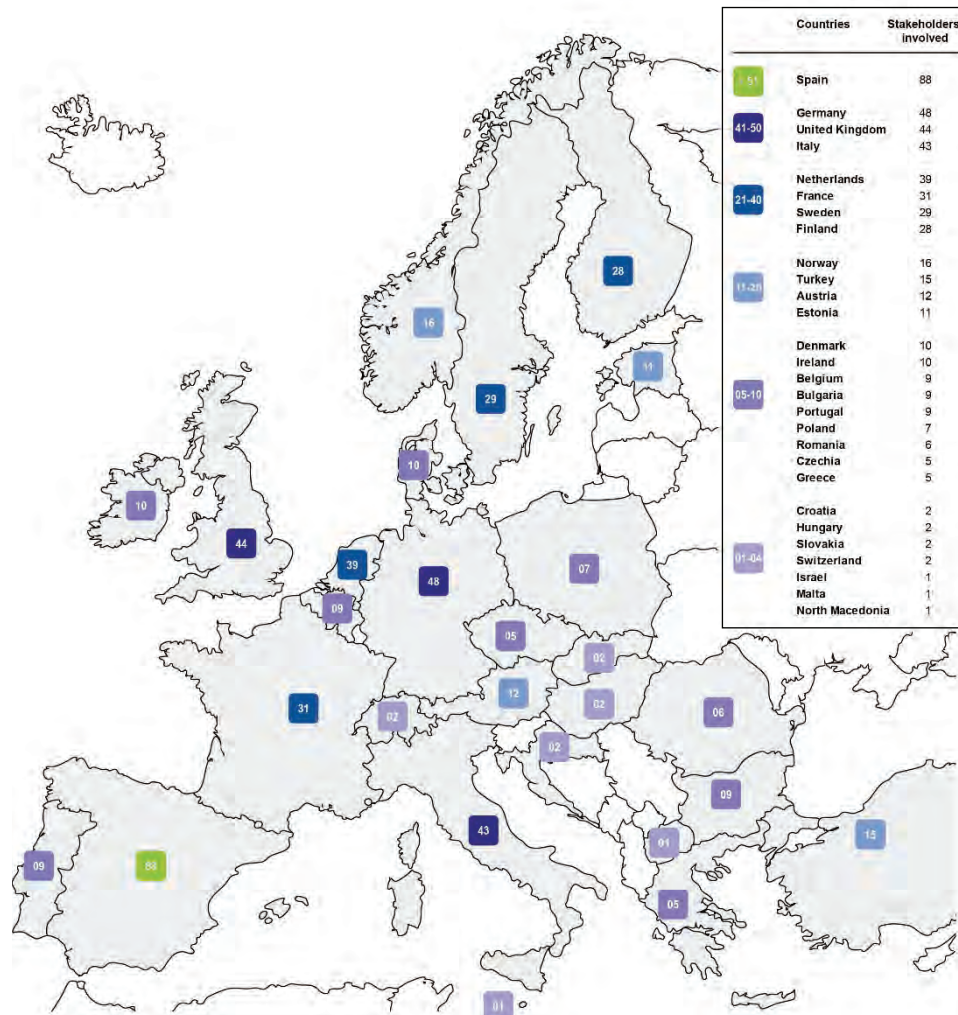

Figure 7: Participants stakeholders per Countries participation in H2020 (image elaborated by authors on a set of data source period 2014–2018 (end) [1,2,3])

Renewable Energy Sources and additionally Building Envelop retrofitting [Figure 11a];

- Mobility and Transport – among which the most successful topics has been Electric, Hybrid and Clean Vehicles and additionally Clean Fuels and Fueling Infrastructure[Figure 11b];
- ICT - among which the most successful topics has been Building Energy Management System and additionally ICT as Planning Support [Figure 11c];
- Energy System Integration – among which the most successful topics has been Electrical Energy Storage and additionally District heating and Cooling[Figure 11d];
- Others– among which the most successful topics has been Smart Cities and Communities and

additionally Demonstration Projects, and Integration of Energy Systems, ICT and transport in Cities [Figure 11e].

3. 2020 and beyond

The White Paper on the future of Europe and the previous reflection papers showed that the EU27 has faced and still will face a wide range of challenges in the period up to 2025 and beyond. Among these there are current trends that will last relevant for decades to come, such as demographic change e social cohesion, economic convergence, digital revolution, globalization and climate change.

Sustainable development has - for a long time - been a central and core topic of the European project. Today

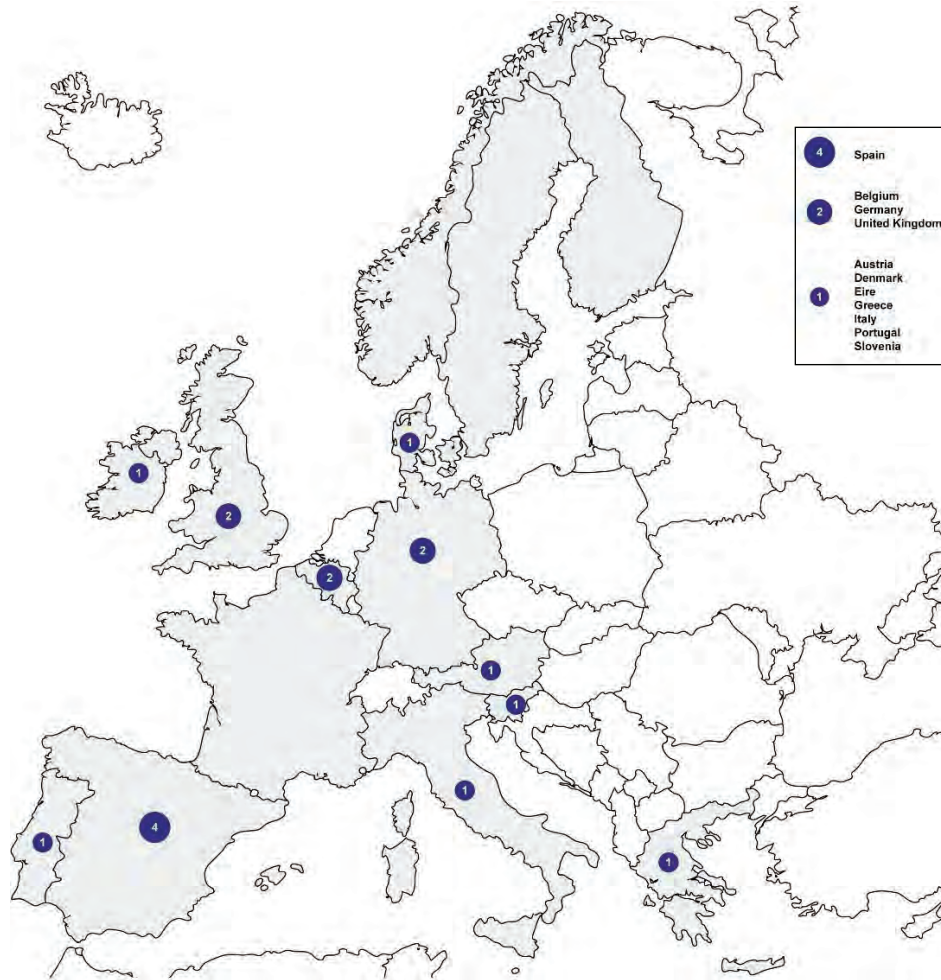

Figure 8: Project Leaders participating in Smart Cities related topics projects in H2020 (image elaborated by authors on a set of data source period 2014–2018 (end) [1,2,3])

European Member State face many challenges related to sustainability: youth unemployment, ageing population, climate change, pollution, sustainable energy and migration. The 2030 United Nation Agenda for Sustainable Development and the sustainable development goals (SDGs) represent a priority for EU policy, both internally and externally. The economic, social and environmental dimension, which are at the heart of SDGs, have been incorporated in several EU budget and spending programs. They have been central into the Europe 2020 strategy to boost education and innovation (smart), low carbon emissions, climate resilience and environmental protection (sustainable), job creation and poverty reduction (inclusive).

Many of the programs promoted by EU are now a sort of trademarks in the daily livfe of European citizens. Indeed, there is still room to further improve

their performance and increase their impact, avoiding overlap and stimulating combination of instruments thus promoting alignment. The current generation of programs have promoted major reforms providing more funding on key Europeans priorities such as employment, social inclusion, research and innovation skills, energy resource and efficiency. On the other side on the other side policies to manage have become increasingly complex, hampering on-ground implementation and creating delays: layers of controls and bureaucratic complexity make it difficult for beneficiaries to access these funds and deliver projects quickly.

Indeed, urban planning activities have changed thanks to technological development promoted also by Research Development & Innovation programs. The budget constraints and the complexity of urban investments needed

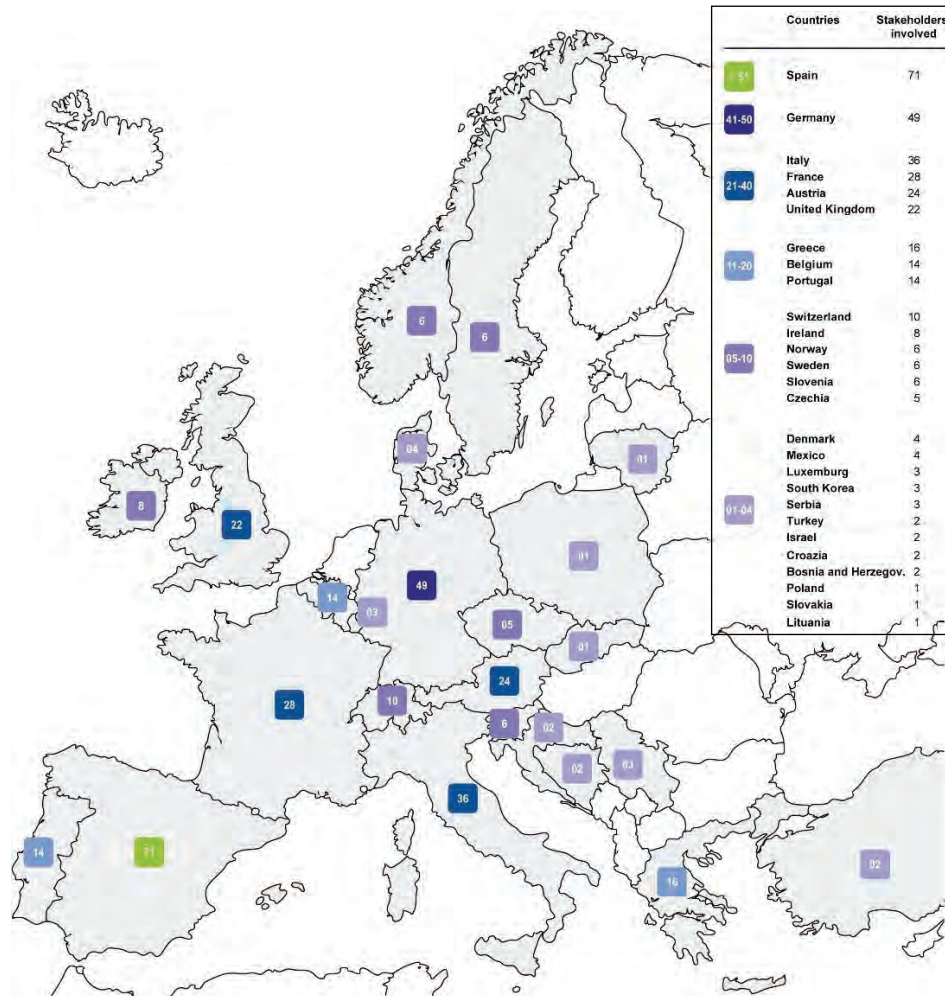

Figure 9: Stakeholders participation per countries in Smart Cities related topics projects in H2020 period 2014–2018 (end) (image elaborated by authors on a set of data source [1,2,3])

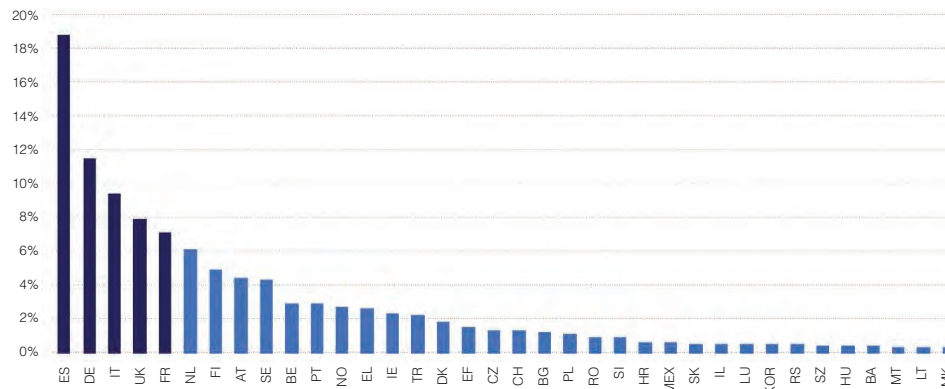

Figure 10: Countries per participation in Smart Cities related project (image elaborated by authors on a set of data source [1,2,3])

for Smart Cities and Communities solutions led city administrations to require the involvement of private players thus adapting the governance of cities in order to

attract them. Therefore, Smart Cities can evolve thanks new modes of value creation through the intermediation of public-private partnerships, cross-sectorial collabora-

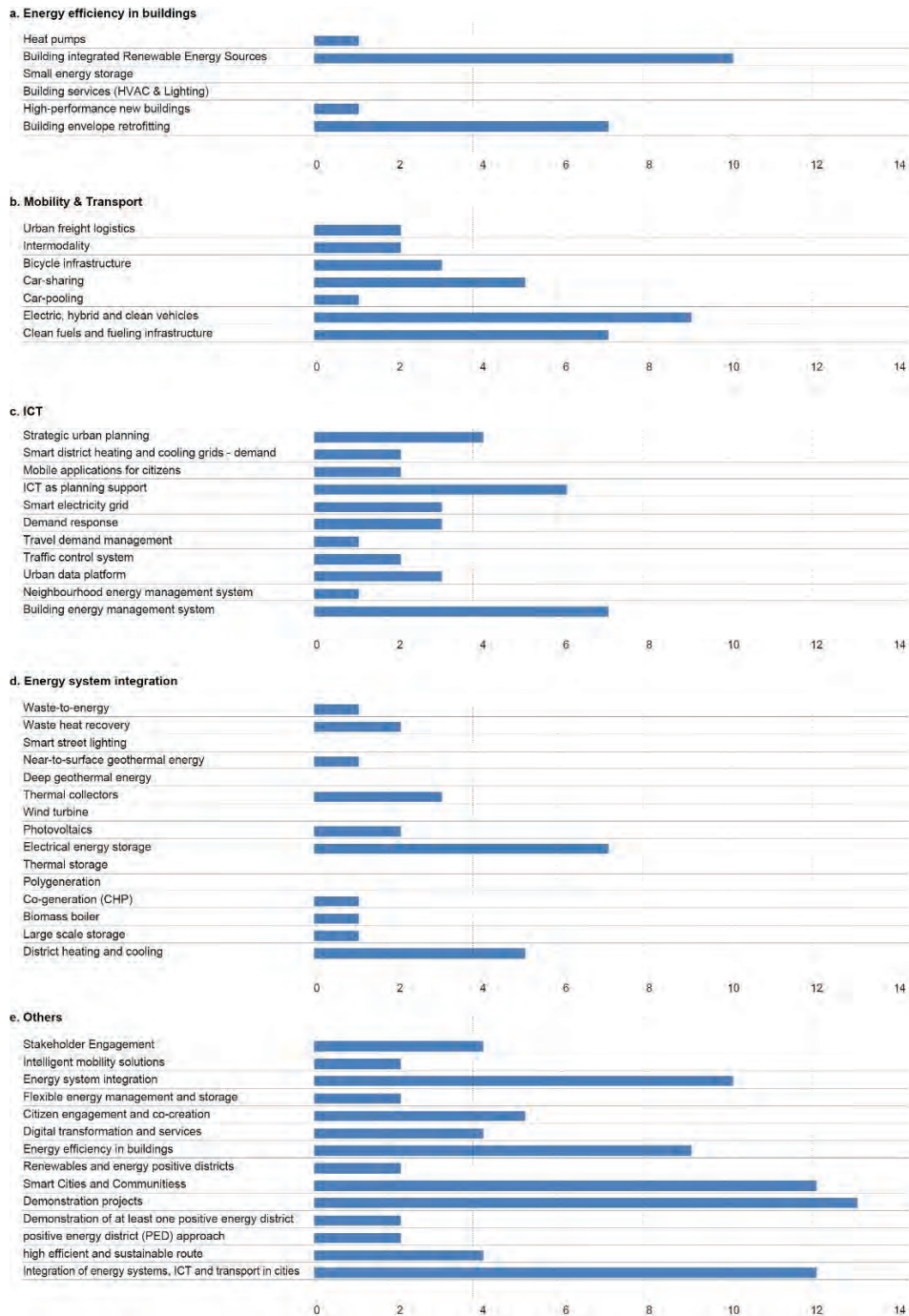

Figure 11: Keywords for specific topics: (a) Energy Efficiency in Buildings, (b) Mobility and Transport, (c) ICT, (d) Energy System Integration, (e) Others. (image elaborated by authors on a set of data source [1,2,3])

tions, city-led “open innovation marketplaces” and other forms of governance.

We assume that there is not a unique way or a single approach to stimulate transitions of a city into a smart city; cities in Europe have adopted different solutions, each of them reflecting specific circumstances.

4. Conclusion

According to above consideration, it appears that three basic elements could best describe the European vision about Smart Cities. The first is that there is not a single vision for the European Smart City, but there have been as many visions as there are Europeans, as social

realities within Europe differ greatly, depending on where people live and work. Then the second is that cities in Europe are and want to be places of advanced social progress, platforms for democracy, cultural dialogue and diversity as well as places of green, ecological and environmental regeneration. Last but not least that Smart cities should be regarded as systems able to catalyze sustainable economic development, resilience and high quality of life making a strategic use of information and communication infrastructure and/or services in a process of transparent urban planning and management.

Therefore if we refer to the European way to promote transition towards Smart Cities we could say that it has been in the last decade that cities started to become smart, not only because of automatic routine functions (serving end-users, traffic system and transport, buildings and/or energy providers) already in place, but moreover because data - deriving from ICT applications - have been used to understand, analyze and, recently, plan the city to improve efficiency, equity and quality of life for citizens.

According to this we believe that the transition process which will pave pathways towards smart cities to come will be mainly focus on setting up, deployment, roll out and scalability on a set of already existing smart solutions

Applying smart cities solutions to limited-scale contexts has certainly enabled the testing of SCC technologies, governance models and citizen involvement; however, what is needed now, in the next future, is to promote scalability and replicability of solutions, bearing in mind that “there is no single element that represents more than others an obstacle or an enabler to the roll-out of SCC solutions”.^x

For the near future, we need to focus on similarities in smart cities Research Development & Innovation projects (i.e. paradigmatic or technological enabling factors on which various solutions are based, ways to integrate single specific technology in a whole ecosystem of interoperable solutions,...). If we consider each SCC solution as a brick of Lego, we understand that while each brick has been made as a separate object, it needs to be assembled and integrated in a more structured system like the one which Smart City paradigm offers.

In next future Smart Cities are approaching a critical phase: behind many theoretical discussions, it is now

necessary to create a realistic pathway of SCC applications/solutions.

This is really the most challenging step of the pathway: it must be more pragmatic, as there will be select only those SCC solutions which have been experimented in the conceptual expansion phase. That's why, in the near future, urban projects requirements will evolve and specifications will be more compelling, allowing no more single, isolated interventions as highly technological islands, but interconnected ones. According to this, pilot RD&I projects will shortly change: not only a demonstration of technological effectiveness in achieving the desired performance or KPIs, but competitive business models with a high level of replicability and scalability, widely accepted by the largest group of stakeholders such as RD&I networks, government, real estate, process management, urban services, design and construction, e-commerce, analyst, ICT and Big data, financial/funding, social/civil society,...).

It is a fact that today we still do not have a smart city, or rather we have a limited-scale smart city context, and we have several SCC (Smart Cities and Communities) solutions where the use of ICT infrastructure promotes a better understanding of success factors for their deployment and roll-out.

Therefore, the next step to move towards a wider European idea of Smart Cities pass through the idea of positive energy district for a sustainable urbanization thanks SCC solutions - already experimented on a limited-scale context; this appears to be the most reliable opportunity.

Highlights about next European Research Development & Implementation programme on Smart Cities and Communities are described in the Implementation Plan SET-Plan Action 3.2 which focus on “Europe to become a global role model in integrated, innovative solutions for the planning, deployment and replication of Positive Energy District”; the aim is to support the 100 Positive Energy District by 2025 for a sustainable urbanization.

The approach to PED will require an open innovation model for planning, deployment and replication, different from the one adopted by the Smart Cities paradigm where tools, technologies and platform have been - mainly - designed among several stakeholders (Governmental, Research and Innovation, Design/Construction, Real Estate, urban Services, Analyst, IT project and Big data, Social/Civil Society, Municipality). In next future Cities and Municipalities will be the stakeholders who need to take a leading role in the integrated

^x Analysing the potential for wide scale roll-out of integrated SCC solution
- Final Report, 2016

and holistic planning of PEDs, aligning it with their long-term urban strategies, while all the others stakeholders (mentioned above) will play the vital role as solutions providers as well as Citizens will take a new role as prosumers with active participation.

Acknowledgement

This article is a part of the EERA Joint Programme on Smart Cities' Special issue on Tools, technologies and systems integration for the Smart and Sustainable Cities to come [5].

References

- [1] **Cordis, EU** [https://cordis.europa.eu/search/en?q=contenttype%3D'project'%20AND%20\(programme%2Fcode%3D'H2020'\)%20AND%20\(lighthouse'\)](https://cordis.europa.eu/search/en?q=contenttype%3D'project'%20AND%20(programme%2Fcode%3D'H2020')%20AND%20(lighthouse')&p=1&num=10&srt=contentUpdateDate:decreasing)
- [2] **SCIS, EU** <https://smartcities-infosystem.eu/scc-lighthouse-projects>
- [3] **European structural and investment funds, EU** <https://cohesiondata.ec.europa.eu/2014-2020/ESIF-2014-2020-FINANCES-PLANNED-DETAILS/e4v6-qrrq>
- [4] The making of Smart Cities: best practice across Europe, EU Smart Cities Information System, Empowering Smart Solutions for better cities, DG Energy, 2017
- [5] Østergaard PA, Maestosi PC. Tools, technologies and systems integration for the Smart and Sustainable Cities to come. *Int J Sustain Energy Plan Manag* 2019;24 2019. <http://dx.doi.org/10.5278/ijsepm.3450>



Modelling the future low-carbon energy systems - case study of Greater Copenhagen, Denmark

Sara Ben Amer*, Rasmus Bramstoft, Olexandr Balyk and Per Sieverts Nielsen

Department of Technology, Management and Economics, Technical University of Denmark, Produktionstorvet, building 424, 2800 Kgs. Lyngby, Denmark

ABSTRACT

In the light of insufficient climate policy on the global and national scale, some ambitious cities are becoming frontrunners of the climate action. Copenhagen, Denmark, is one of them and aims to achieve a CO₂-neutral energy system in 2025. Reaching this goal requires, among other, changes in energy supply portfolio, which can be assessed using energy systems modelling. The aim of this study is to construct and evaluate scenarios for sustainable electricity and heat supply in Greater Copenhagen with a particular focus on the new district, Nordhavn. The energy scenarios are modelled with the energy system model Balmorel, and they are assessed and compared with focus on heat and electricity prices and CO₂ emissions. Sensitivity analyses are conducted considering changes in the coefficient of performance (COP) of heat pumps and the discount rate. The results show that expanding Copenhagen's district heating system to Nordhavn is a promising solution from a socio-economic perspective. If it is chosen that the heating supply in Nordhavn should come from a local source, power-to-heat technologies are preferred. Despite the narrow geographical focus, the challenges discussed in this paper and the method developed are relevant for other urban areas in Europe that aspire to have sustainable energy systems.

Keywords:

Energy systems modelling;
Local energy planning;
Urban energy systems;
Energy scenarios;
Balmorel;

URL: <http://doi.org/10.5278/ijsepm.3356>

1. Introduction

CO₂ emissions from the energy sector contribute to the climate change significantly. While policies are required for setting the framework conditions, in an increasingly decentral energy sector, the involvement of local municipalities and communities is crucial.

Copenhagen aspires to become CO₂ - neutral by 2025 [1]. This goal encompasses power, heating and transportation. Heating uses up to 40% of the total energy consumption and is the sector over which Danish local municipalities have strongest influence. This paper focuses mainly on heating, electricity and fossil-fuel free transportation.

Copenhagen is one of 33 municipalities in the Capital Region and Region Zealand which are to be free from

fossil fuels in 2035 [2]. Devising Copenhagen's roadmap towards the carbon-neutrality goals requires a feasibility evaluation, which can be conducted with energy systems modelling. The role of combined heat and power plants (CHPs) and heat pumps (HPs) is considered here, in view of varying availability of biomass and waste and the possibility of wind power providing more than 100% of electricity supply. Compared to a simple feasibility study, modelling takes into account a dynamic system integration across energy sectors, cost-efficient utilization of storage facilities, cross-border electricity fluctuation and endogenously computed electricity prices. Therefore, the optimization of investment decisions is dynamic and coherent, because the model can calculate key input parameters determining the economic feasibility.

*Corresponding author – e-mail: sbea@dtu.dk

Acknowledgement of value

I am not formally involved in the research conducted by Sara Ben Amer et al., but I believe that both the methodology and results authored by them could have a positive effect on my own area of activity, by providing perspectives for planning the future CO₂-neutral Copenhagen.

Niels Bethlowsky Kristensen, Climate and energy planner in the City of Copenhagen

Abbreviations

CHP - combined heat and power
COP - coefficient of performance
DH - district heating
EV - electric vehicle

GC - Greater Copenhagen
HP - heat pump
P2H - power-to-heat

This paper's purpose is to construct and evaluate scenarios for energy supply in Greater Copenhagen (GC), by comparing different electricity and heating supply mixes, prices and CO₂ emissions. A similar approach for another town is taken e.g. by ref. [3]. The results form a basis for providing recommendations for the municipal energy planning activities, focusing on integrated energy supply. This study aims to answer the following research questions, focusing on Copenhagen and Nordhavn:

- What scenarios are plausible as of 2020, 2025, 2035 and 2050?
- Based on the results of the modelled scenarios, which energy mix is preferable from a socio-economic perspective?
- How sensitive are the results to selected assumptions?

Methods for modelling of decentralized and community energy systems have been reviewed e.g. by refs. [4,5]. This Special Issue contains articles which focus on modelling of a specific Swedish municipal energy system [6] and a local district heating system in Poland [7]. The Danish examples of municipal analyses are: modelling of energy scenarios implementing HPs, wind power, biomass and electrolyzers in Sønderborg [8] and heat supply and heat savings in Helsingør [9]. Ref. [10] found out that large-scale HPs operate better when connected to the distribution instead of transmission grid in Copenhagen's DH system. Ref. [11] showed how heat savings, HPs and low-temperature DH could be implemented in Copenhagen. Refs. [12,13] highlighted the need for aligning local energy planning with national strategies. Ref. [14] assessed options for locating a HP in Nordhavn. Ref. [15]

evaluated an integrated power, heat and transport system in Nordhavn, where HPs and electric vehicles (EVs) were implemented.

While all this literature has touched upon the future energy system in Copenhagen, to our knowledge there is no-peer reviewed research on energy planning and investment decision-making for the area of GC, which takes into account the synergies across energy sectors and geographical space. This article's contribution lies in developing and applying a modelling tool, which can be used for local energy planning in a national and regional energy system context – taking the future energy mix, the Nordic electricity market and electricity prices into account. Since the Balmorel tool used allows both investment and operation optimisation, this study also contributes to the area of energy scenario development, providing knowledge background for complex decisions of designing the future heating supply. Wider socio-economic consequences, such as employment, are out of scope of this article and are discussed e.g. in ref. [16].

This paper is structured as follows: Section 2 describes the methodology, Section 3 outlines the input data and assumptions, Section 4 presents the findings, and Section 5 discusses the results. The paper concludes in Section 6.

2. Methodology

2.1. Energy systems modelling with Balmorel

The overall methodology for this paper is scenario development and analysis. We use the energy system model, Balmorel, to model our scenarios. Balmorel is an open-source energy system optimisation tool,

implemented in GAMS language [17]. It is a partial equilibrium model, built upon a bottom-up approach. Balmorel simulates the energy system's supply and demand and optimizes the operation of and investments into production units, calculating the most cost-effective mix of technologies for a given scenario [18] by minimizing the total system costs, including annualized investment costs, operation and maintenance and fuel costs, incorporating constraints e.g. heat and electricity coverage for each time period, emission limits. To represent the costs and technical bottlenecks in electricity and heat transportation, Balmorel distinguishes geographical levels (countries, regions and areas) [18]. Using time series, the model represents variation in intermittent technologies such as wind and solar power, demands and storages.

Balmorel is a deterministic model, which allows optimising the energy system with varying yearly foresight, i.e. myopic, partial, and full foresight. Myopic foresight refers to a situation where no information regarding future years is given. In full foresight mode, the model contains detailed assumptions about future energy targets, cost reductions, fuels prices etc., and thus can provide globally optimal solutions. In reality, we have a limited knowledge about the future: policy frameworks, fuel prices, technology costs developments etc. Therefore, in this paper, a partial foresight looking at one simulated period ahead is applied, reflecting a partial knowledge about the future: the situation that decision-makers have perfect foresight only within the simulated year and within the following simulated year.

Except for applications mentioned in ref. [17], Balmorel has been used in the context of Copenhagen in refs. [2,19].

In this paper, we build upon the existing Balmorel model and further extend the modelling framework to include Nordhavn, as a separate part of the GC area. Such an approach allows local energy planning in an integrated national and Nordic energy systems context. Moreover, by implementing specific technological options - energy scenarios, we conduct a comprehensive assessment, supporting future decision making for local energy planning. The modelling framework is adapted to the specific case of GC, but could be applied for other cities around the world.

Energy systems modelling requires the generation technologies, space and time to be aggregated so that the non-linear and complex reality is represented. Due the high computational time of the optimisation in Balmorel,

a trade-off between technological details and spatial and temporal resolution is necessary. The geographical area for this paper includes Nordhavn, the GC area, the rest of Denmark, constituted by nine other areas, and countries linked with Denmark via transmission lines and the common Nordic electricity market: Germany, Sweden and Norway. In this study, the temporal resolution is 4 representative seasons (weeks) and 56 time periods (representing every 3rd hour throughout the selected seasons), within each season. Thus, the full year is represented by 224 chronological time-steps. The chronological order of the selected time-steps enables the mathematical model to use stretching methods, ensuring that the production and storage levels i.e. both energy and capacity, are sufficiently replicated, as compared to a time resolution of a full year.

2.2. Energy scenarios

This article focuses on GC: the City of Copenhagen and surrounding municipalities, inhabited by 1.3 million people [20]. Nordhavn is a new district in the City of Copenhagen, expected to have 40,000 new residents and 40,000 workplaces by 2030 [21]. The DH network will be extended in the part of Nordhavn closest to the already existing pipes, but more remote areas may use other solutions, due to the expected low energy consumption of buildings. We model and evaluate the following energy scenarios for GC and Nordhavn, analysing years 2020, 2025, 2035 and 2050:

- Reference: the model chooses freely to invest in Nordhavn in either technology: seawater HP, heat storage, solar heating and ground-source HPs.
- Seawater HP: investing in a large seawater HP with thermal storage in Nordhavn.
- DH extension: extension of Copenhagen's DH capacity to cover all Nordhavn¹.
- Individual solutions: optimizing investments in Nordhavn in: solar thermal collectors, ground-source HPs, thermal storage and electric boilers.

In this study, we exclude air-to-air and air-to-water HPs, because the first one can only cover up to 80 % of the space heating demand and can only deliver heat in the room where it is installed, and the latter is likely to exceed required noise levels in dense city areas [22]. Although expensive, ground-source HPs suit the urban environment best, because they are silent and perform stably over the

¹ The DH network is assumed here to be already expanded, thus the cost of expansion is not part of the optimisation

year. To reduce the size of area required for drilling, vertical pipes instead of horizontal can be used.

We assess the scenarios with the following criteria: average heat and electricity price and CO₂ emissions.

3. Input data and assumptions

3.1. Energy demand and supply

The Balmorel model contains data for electricity and district heat demand for Denmark, Sweden, Norway and Germany. This article focuses on the Copenhagen area, represented in the model as two areas: GC and Nordhavn. The district heating network in GC covers 17 municipalities and is one coherent system, where heat can be exchanged among different district heating providers. In GC heat is produced primarily in 4 CHP plants (using biomass, natural gas and coal) and 3 waste incineration plants and, if needed, stored in heat accumulators. There are also 30 peak load units [14]. Recently, CHPs in GC have undergone a retrofit to enable burning biomass.

The projected heat demand for Nordhavn is based on ref. [17].

Figure 1 shows the yearly values for heat and electricity demand modelled in this paper. The heat demand curves shown in the upper part of Figure 1 (please note the axes) are different because in GC the demand decreases, while no additional heat savings are expected in Nordhavn, which predominantly consists of new energy-efficient buildings.

Figure 1 also depicts the projected electricity demand for the two areas, represented by the demand profile from Eastern Denmark. The electricity demand is contained within Eastern Denmark, corresponding to a bidding area in the power market Nord Pool. This demand covers both the “classical” demand and demand for EVs and is adopted from the ENTSO-E Global Climate Action scenario [23].

We assume that the transportation sector is decarbonised in the future, calling for biofuels especially for long-haul transportation. To simulate this, we have

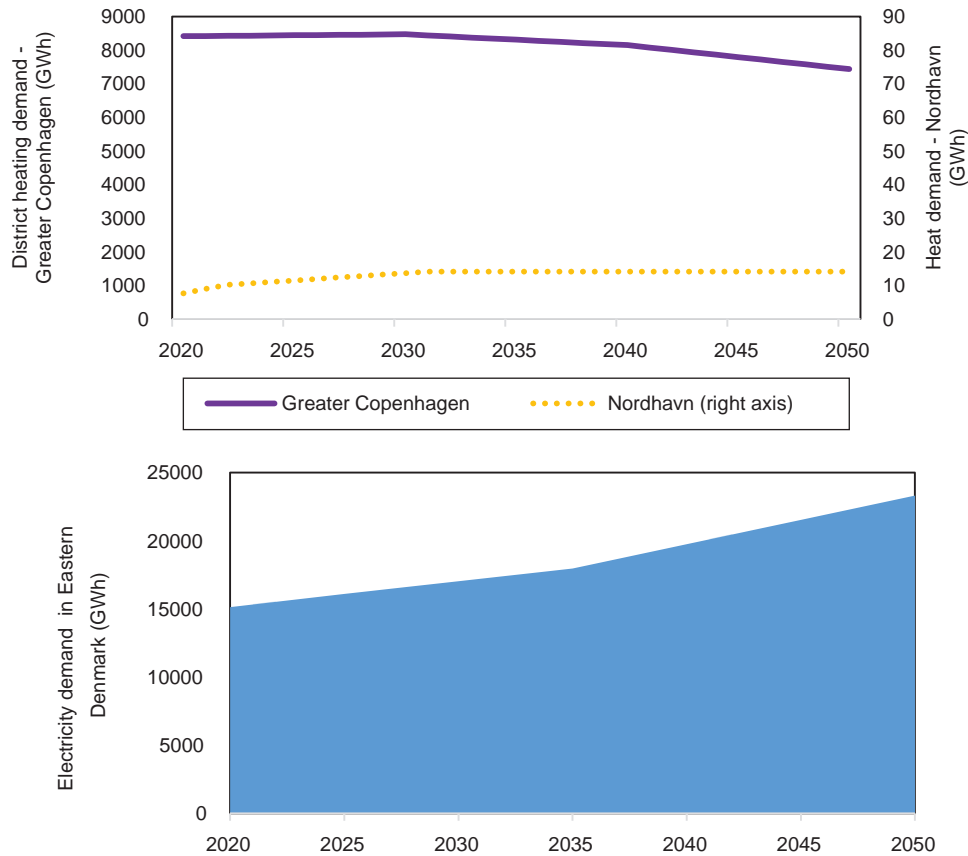

Figure 1: Projected heat demand in GC and Nordhavn (top) and electricity demand (down) in Eastern Denmark (GWh). Please note that heat demand values for Nordhavn are presented on the right axis

implemented excess heat production of 14 PJ for Denmark, which represents the excess heat supply for producing 50 PJ biofuels in Denmark [24]. The transition to electric vehicles is, as mentioned, included in the projected electricity demand.

3.2. Techno-economic data

Ref. [25] describes the data applied in the modelling, except for data on Nordhavn, based on ref. [26]. The investment and O&M costs and efficiencies come from refs. [22, 27], except for the seawater HP, whose investment cost is based on refs. [28, 29]. The COP of 3 is based on ref. [30], O&M costs are the same as the ground-source HP, considering that sea temperature is constant at depth.

Fossil fuel prices are based on ref. [23], biomass prices on ref. [31]. This study is conducted from the socio-economic perspective: excluding subsidies and taxes and applying 4% discount rate over 20 years of investment.

4. Results

4.1. Electricity production

The optimised electricity generation portfolio influences the electricity prices, which are essential for determining the optimised heat production mix, seen from a socio-economic perspective. Figure 2 illustrates

the resulting transition of the electricity generation mix over time, for all the simulated countries and for Denmark, with a split between Western and Eastern Danish grids i.e. DK1 and DK2, respectively. The general trend in the decarbonisation pathway of the power system is the increased penetration of the variable renewable energy sources: wind and solar. Moreover, in DK2, where GC is located, an increased penetration of solar and wind power causes biomass to be phased out in 2035.

4.2. Heat production

Figure 3 illustrates the resulting transition of the heating sector in Denmark, GC and Nordhavn. In Denmark and GC, a decrease in DH demand is expected, mainly due to the assumed heat savings, see also section 3.1. Currently, a large share of heat in the Copenhagen DH network is produced using biomass, municipal waste and coal. However, due to CO₂ emission reduction and renewable energy targets, coal is to be phased out. Figure 3, similarly to Figure 2, illustrates that a phase out of biomass in Copenhagen after 2025 is socio-economically optimal. This result complies with the expectation that scarce biomass needs to be freed up for decarbonising the part of transport where electricity is not technically possible yet. The results also show that power-to-heat (P2H) has a promising socio-economic potential.

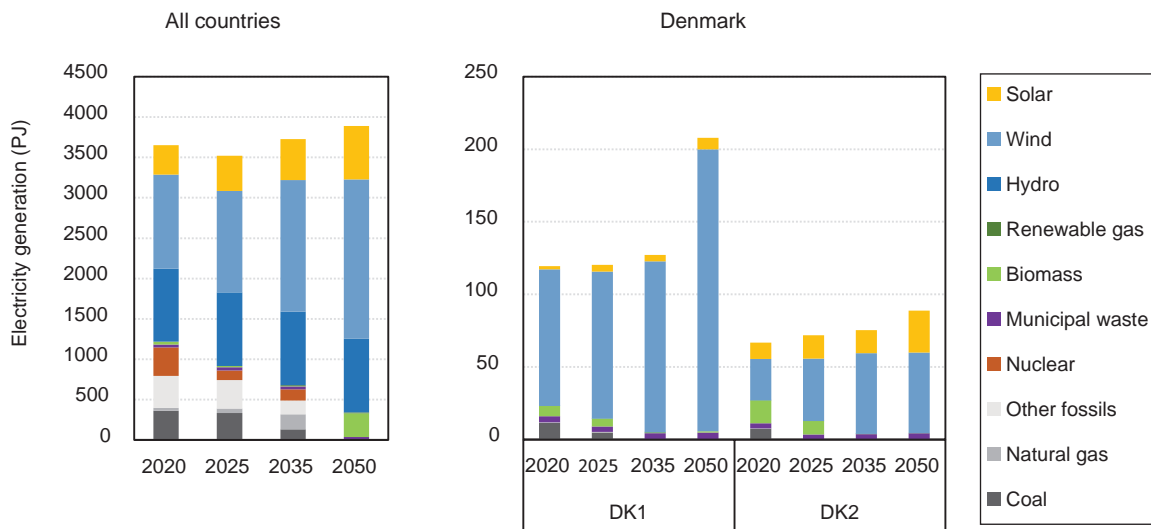

Figure 2: Electricity production per fuel in 2020, 2025, 2035 and 2050 in all the simulated countries (left) and in Denmark (right), divided into Western (DK1) and Eastern Denmark (DK2) (PJ)

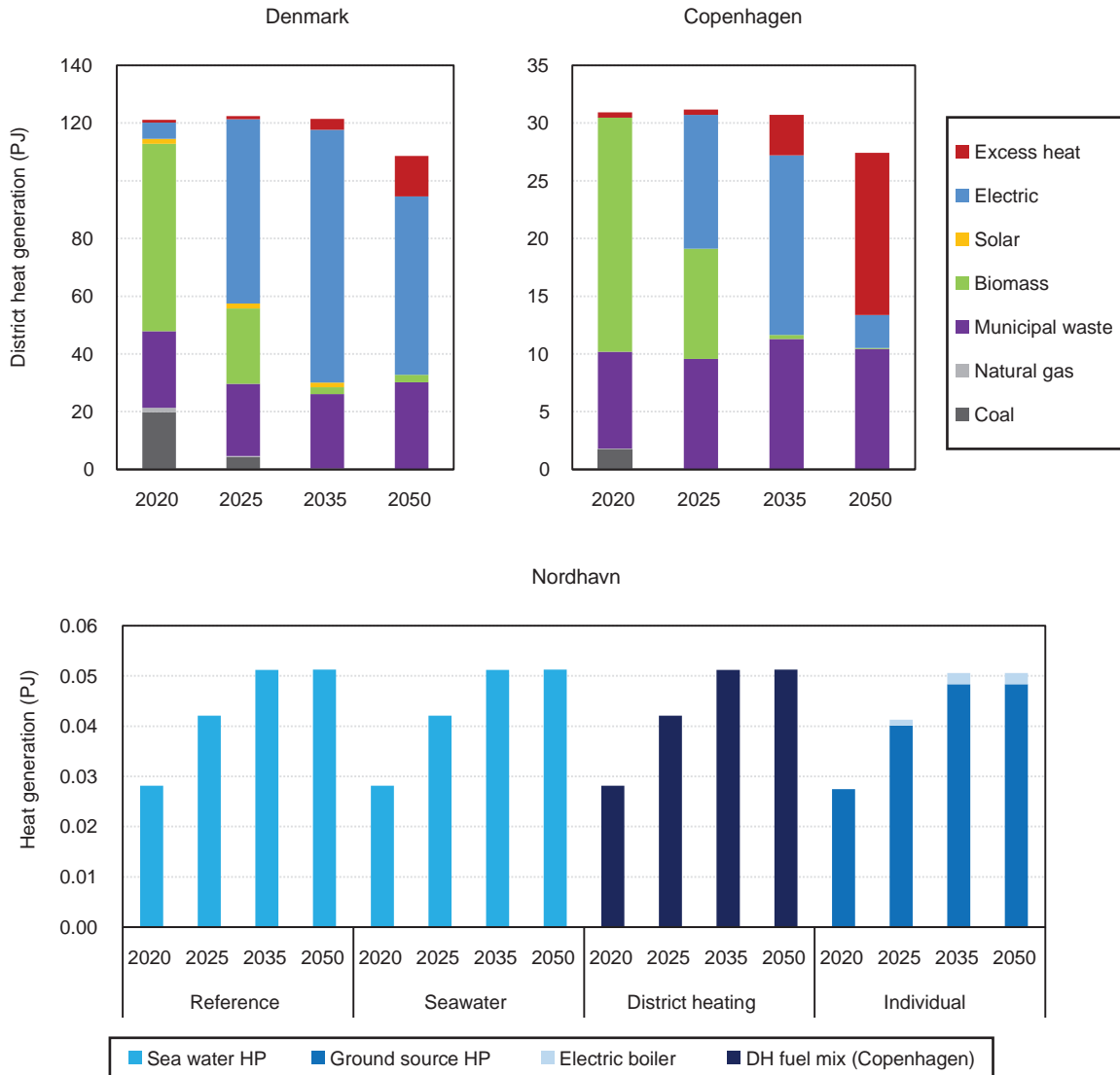

Figure 3: Heat production mix in 2020, 2025, 2035 and 2050 in Denmark, GC and Nordhavn (PJ)

Focusing on Nordhavn, a local seawater HP seems to be a promising technology in case the Copenhagen’s DH network is not extended there. Local HP technologies are socio-economically viable if the area is not connected to the Copenhagen DH network, however, in case a connection is possible, the model finds this solution more feasible than installing HPs.

As discussed in section 3.1, transport is expected to use biofuels in long-haul transportation. We simulate this by implementing excess heat production (biorefineries) in the model. The GC area has highest potentials for cost-efficient utilisation of the excess heat in the DH

network, so all of the Danish excess heat capacities are located here, see also ref. [32].

4.3. Heat and electricity price

Table 1 shows the simple annual average heat and electricity prices obtained from the modelling and indicates that prices vary over years. Since the excess heat production covers a high share of the DH demand in Copenhagen, the annual average heat prices are lower in Copenhagen than Nordhavn in all modelled years except for 2035. This indicates that DH expansion to Nordhavn could be a relevant solution. Moreover, P2H technologies are

Table 1: Annual average heat in Copenhagen and Nordhavn (EUR/GJ) and electricity prices in Eastern Denmark (EUR/MWh)

		Average heat price (EUR/GJ)		Average electricity price (EUR/MWh)
		Copenhagen	Nordhavn	Eastern Denmark (DK2)
Reference	2020	1.5	1.9	22.5
	2025	1.8	1.9	21.7
	2035	4.1	3.7	38.1
	2050	1.5	6.0	62.1

heavily invested in, so the correlation between electricity and heat prices is visible and the rise in the price of heat in Nordhavn follows the projected increase in the electricity price.

To provide a deeper understanding of this correlation, Figure 4 illustrates the dynamics between heat production and electricity and heat prices for Copenhagen and Nordhavn in 2035. Figure 4 shows that waste incineration plants and excess heat are supplied continuously as base load production throughout the year in Copenhagen. Moreover, P2H technologies generate heat at periods with low electricity prices, and heat storages are used when economically feasible. The correlation between P2H generation and electricity prices is evident when focusing on Nordhavn in 2035.

4.4. CO₂ emissions

The pathway of CO₂ reduction in Denmark and Copenhagen shows a steep reduction already between 2020 and 2025 in the electricity and district heating systems, followed by the transition to carbon-neutrality. In the simulations, the CO₂ emissions by 2020 are calculated to be 4860 kt/y in Denmark, where GC contributes with 640 kt/y. Compared to the 2018 data from the City of Copenhagen, which shows 925 kt/y from electricity and DH sectors [33], the calculated number (encompassing all municipalities in GC) is low. However, the recent conversion to biomass is expected to reduce the CO₂ emissions from DH and electricity substantially. The model shows that GC can reach zero emissions in the DH and electricity sectors in 2025, whereas Denmark still emits 1200 kt/y CO₂ in 2025. Copenhagen achieves its target by phasing out fossil fuels. By 2035 the model projects Denmark to be nearly carbon-neutral regarding electricity and district heating production.

4.5. Sensitivity analyses

We have conducted sensitivity analyses to examine how results change depending on altering the COP of the

seawater HP to 2.8, and of the ground-source HPs to 3.5, and changing discount rate to 2% and 6% instead of 4%. Table 2 shows the resulting differences in heat and electricity prices.

Overall, changes occur both in average heat and electricity prices. The influence of COP is mainly visible in Nordhavn (where a seawater HP would be installed) and is within the range of 5-9% increase in average heat price.

As expected, a lower discount rate results in a lower heat price in both Copenhagen and Nordhavn. The opposite happens for a higher discount rate. This effect is especially visible in 2025 and 2035, where many new investments take place. This result shows that our findings highly depend on the choice of discount rate.

5. Discussion

In this paper, we find that the expansion of Copenhagen's DH network to Nordhavn shows a promising perspective seen from a socio-economic point of view. In case the heating demand in Nordhavn is supplied by a local source, P2H technologies are chosen. These results are in line with the findings in ref. [26], where analyses of heat supply alternatives for Nordhavn, focusing on changing electricity price, COP of HPs, investment cost and heat demand, were conducted. In that report, almost all the cases showed that expanding the Copenhagen's DH network would pay off from a socio-economic perspective, but lower electricity prices would significantly improve the cost-effectiveness of HPs.

The results in this article are obtained by using the energy system model Balmorel. Although it is a detailed model, it uses a number of assumptions and simplifications. To show how results depend on some of the assumptions, we conducted sensitivity analysis. The choice of heat supply may also depend on qualitative aspects, such as security of supply and comfort, which were excluded in this analysis. Moreover, our socio-economic analysis does not include taxes, while

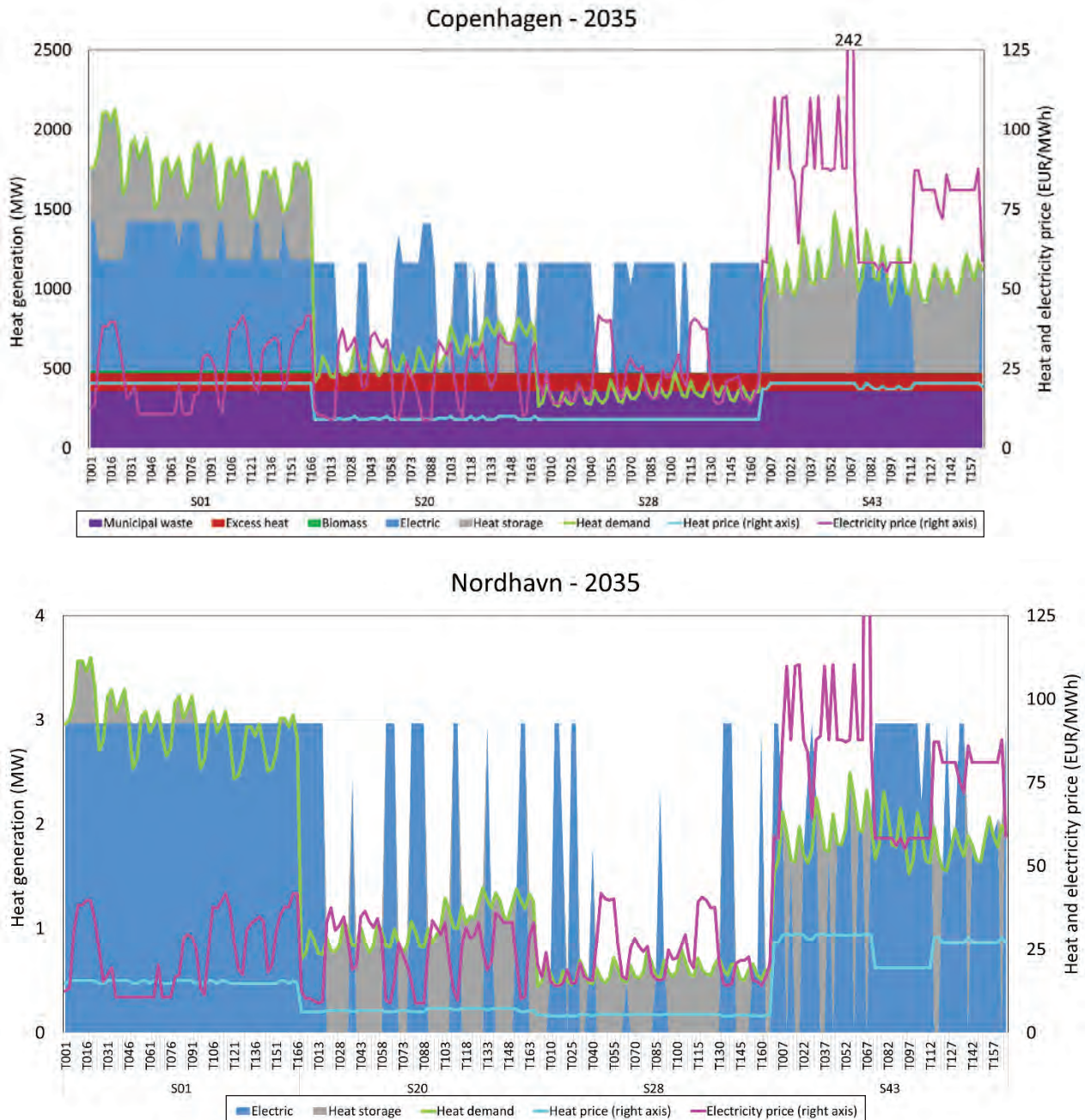

Figure 4: Dynamics between heat production and electricity and heat prices for GC (top) and Nordhavn (down) in 2035 in the reference scenario

the economic attractiveness, seen from a private-economic perspective, may be reduced for e.g. P2H technologies. This is because taxes constitute about 50% of the final electricity tariff for customers. On the other hand, there are exemptions for users that consume more than 4000 kWh electricity for HPs a year. A real-life illustration of the current tax structure

is the biomass base power and heating production. The current tax structure, where biomass is free from taxes, means that it is a more profitable solution than e.g. HPs, which are affected by electricity taxes. For comparison, ref. [34] has conducted a detailed modelling of the framework conditions for DH in the Nordics.

Table 2: Changes in average heat and electricity prices due to the lower COP of HP and discount rate, as compared to the Reference (%)

	Year	Average heat price		Average electricity price
		Copenhagen	Nordhavn	Eastern Denmark
Seawater HP COP=2.8; ground-source HP COP=3.5	2020	0%	9%	0%
	2025	0%	9%	0%
	2035	0%	5%	0%
	2050	2%	7%	0%
2% disc. rate	2020	-3%	-6%	-4%
	2025	-36%	-28%	-28%
	2035	-35%	-26%	-24%
	2050	-7%	-9%	-3%
6% disc. rate	2020	0%	9%	5%
	2025	47%	32%	34%
	2035	25%	14%	17%
	2050	-3%	4%	4%

Although this analysis is conducted for Denmark - specifically for GC, the method and tools applied can be used for a similar analysis of other geographical location. In this way, the perspectives can be broadened, creating valuable insights into energy planning in smart sustainable cities.

6. Conclusions

In this paper, we have developed and applied a method for energy system modelling of Greater Copenhagen with the Balmorel model. We consider the developed model a suitable tool to represent an urban area while keeping connections to the rest of Denmark and Nordic electricity market.

We have constructed and evaluated scenarios for energy supply of Nordhavn focusing on heat and electricity generation mixes and prices, and CO₂ emissions. All of the scenarios resulted in a steep reduction in CO₂ emissions already between 2020 and 2025 in the electricity and district heating systems, followed by a transition to carbon-neutrality. We found that DH expansion to Nordhavn and a seawater HP are plausible solutions. P2H technologies, municipal waste, heat storages and excess heat would be main supply technologies in the future energy transition. To examine the sensitivity of the scenarios, we conducted a sensitivity analysis, where we reduced the COP of HP technologies and tested how discount rates of 2% and 6%, influenced the results.

Slight changes in COPs of the HPs modelled only have little influence on the results, but our findings highly depend on the choice of discount rate.

Despite the narrow geographical focus, the challenges discussed in this paper and the method developed are relevant for other urban areas in Europe that aspire to have sustainable energy systems. By assessing a number of scenarios for energy supply, their consequences can be compared to provide recommendations for the planning process not only in GC, but also in other similar projects elsewhere.

The method developed could be also used by energy planners in other cities, beyond Copenhagen, especially where a decision on planning with socio-economic perspective has to be made. It is useful for developing sustainable energy plans for new urban developments and, especially in cities with high DH penetration, to decide for a relevant heat supply option. Recently, more and more cities are creating development projects-urban labs, which will encompass residential, commercial and industrial buildings, as well as smart and sustainable infrastructure, including energy systems.

Acknowledgements

This article was invited and accepted for publication in the EERA Joint Programme on Smart Cities' Special issue on *Tools, technologies and systems integration for the Smart and Sustainable Cities to come* [35]. This

work is part of the CITIES (Centre for IT–Intelligent Energy System in Cities) project funded in part of the Danish Innovation found. Grant DSF 1305-00027B (Det Strategiske Forskningsråd).

References

- [1] City of Copenhagen, CPH 2025 Climate Plan. A green, smart and carbon neutral city, 2012. <https://stateofgreen.com/files/download/1901> (accessed June 1, 2016)
- [2] Energi på Tværs, Fælles strategisk energiplan for Hovedstadsområdet (Common strategic energy plan for the Capital Region), 2018. https://www.gate21.dk/wp-content/uploads/2018/05/EPT_Fælles-Strategisk-Energiplan_WEB_low.pdf
- [3] M.G. Prina, M. Cozzini, G. Garegnani, D. Moser, U.F. Oberegger, R. Vaccaro, W. Sparber, Smart energy systems applied at urban level: the case of the municipality of Bressanone-Brixen, *Int. J. Sustain. Energy Plan. Manag.* 10 (2016) 33–52. <http://doi.org/10.5278/ijsepm.2016.10.4>
- [4] R.B. Hiremath, S. Shikha, N.H. Ravindranath, Decentralized energy planning; modeling and application—a review, *Renew. Sustain. Energy Rev.* 11 (2007) 729–752. <http://doi.org/10.1016/j.rser.2005.07.005>
- [5] G. Mendes, C. Ioakimidis, P. Ferrão, On the planning and analysis of Integrated Community Energy Systems: A review and survey of available tools, *Renew. Sustain. Energy Rev.* 15 (2011) 4836–4854. <http://doi.org/10.1016/j.rser.2011.07.067>.
- [6] V. Heinisch, L. Göransson, M. Odenberger, F. Johannson, A city optimisation model for investigating energy system flexibility, *Int. J. Sustain. Energy Plan. Manag.* 24 (2019). <http://doi.org/10.5278/ijsepm.3328>
- [7] M. Widzinski, Simulation of an alternative energy system for district heating company in the light of changes in regulations of the emission of harmful substances into the atmosphere, *Int. J. Sustain. Energy Plan. Manag.* 24 (2019). <http://doi.org/10.5278/ijsepm.3354>
- [8] D. Sveinbjörnsson, S. Ben Amer-Allam, A.B. Hansen, L. Algren, A.S. Pedersen, Energy supply modelling of a low-CO₂ emitting energy system: Case study of a Danish municipality, *Appl. Energy.* 195 (2017) 922–941. <http://doi.org/10.1016/j.apenergy.2017.03.086>
- [9] S. Ben Amer-Allam, M. Münster, S. Petrovi, Scenarios for sustainable heat supply and heat savings in municipalities - The case of Helsingør, Denmark, *Energy.* 137 (2017). <http://doi.org/10.1016/j.energy.2017.06.091>
- [10] B. Bach, J. Werling, T. Ommen, M. Münster, J.M. Morales, B. Elmegaard, Integration of large-scale heat pumps in the district heating systems of Greater Copenhagen, *Energy.* 107 (2016) 321–334. <http://doi.org/10.1016/j.energy.2016.04.029>
- [11] Mathiesen, B.V., Lund, R., F., Connolly, D., Ridjan, I., Nielsen, S. Copenhagen Energy Vision 2050: A sustainable vision for bringing a capital to 100% renewable energy, 2015. http://vbn.aau.dk/files/209592938/Copenhagen_Energy_Vision_2050_report.pdf.
- [12] D. Drysdale, B. Vad Mathiesen, H. Lund, From Carbon Calculators to Energy System Analysis in Cities, *Energies.* 12 (2019) 2307. <http://doi.org/10.3390/en12122307>
- [13] J.Z. Thellufsen, H. Lund, Roles of local and national energy systems in the integration of renewable energy, *Appl. Energy.* 183 (2016) 419–429. <http://doi.org/10.1016/j.apenergy.2016.09.005>
- [14] J. Wang, S. You, Y. Zong, C. Traholt, Energylab Nordhavn: An integrated community energy system towards green heating and e-mobility, 2017 IEEE Transp. Electrification Conf. Expo, Asia-Pacific, ITEC Asia-Pacific 2017. (2017). <http://doi.org/10.1109/ITEC-AP.2017.8080846>
- [15] S. Klyapovskiy, S. You, H. Cai, H.W. Bindner, Integrated Planning of A Large-scale Heat Pump In View of Heat and Power Networks, *IEEE Trans. Ind. Appl. PP* (2018) 1. <http://doi.org/10.1109/TIA.2018.2864114>
- [16] H. Lund, F. Hvelplund, The economic crisis and sustainable development: The design of job creation strategies by use of concrete institutional economics, *Energy.* 43 (2012) 192–200. <http://doi.org/10.1016/J.ENERGY.2012.02.075>
- [17] F. Wiese, R. Bramstoft, H. Koduvere, A. Pizarro Alonso, O. Balyk, J.G. Kirkerud, Å.G. Tveten, T.F. Bolkesjø, M. Münster, H. Ravn, Balmorel open source energy system model, *Energy Strateg. Rev.* 20 (2018) 26–34. <http://doi.org/10.1016/j.esr.2018.01.003>
- [18] H.F. Ravn, The Balmorel Model: Theoretical Background, 2001. <http://www.balmorel.com/images/downloads/the-balmorel-model-theoretical-background.pdf>
- [19] CTR, HOFOR, VEKS, Varmeplan Hovedstaden 3 (Heat plan for the Capital region), 2014. <http://www.varmeplanho vedstaden.dk/>
- [20] Danmarks Statistik, Folketal den 1. i kvartalet efter køn, alder, civilstand, område og tid (Population on the 1st of the quarter by gender, age, marital status, area and time), (2019). <https://www.statistikbanken.dk/> (accessed May 29, 2019).
- [21] CPH City & Port Development, Nordhavnen. From idea to project, 2012. <https://byoghavn.dk/nordhavn/om-nordhavn/>
- [22] Energinet & Danish Energy Agency, Technology data for individual heating installations, 2018. <https://ens.dk/en/our-services/projections-and-models/technology-data>
- [23] ENTSOE and ENTSG, TYNDP 2018. Scenario Report, 2018. https://docstore.entsoe.eu/Documents/TYNDP_documents/TYNDP2018/Scenario_Report_2018_Final.pdf
- [24] R. Bramstoft, A. Pizarro, I. Græsted, H. Ravn, M. Münster, Modelling of renewable gas and fuels in future integrated energy systems, *Submitt. to Appl. Energy.* (n.d.).

- [25] I. Græsted, F. Wiese, R. Bramstoft, M. Münster, Potential role of renewable gas in the transition of electricity and district heating systems, *Prepr. Submitt. to Energy Strateg. Rev.* (2019).
- [26] HOFOR, Fjernvarmeforsyning af Nordhavn. Projektforslag til Københavns Kommune (District heating supply of Nordhavn. Project proposal for Copenhagen Municipality), 2013. <https://www.kk.dk/sites/default/files/edoc/e19fb5ee-414c-44a9-b31f-779c04262eb2/b710f37c-14ab-468c-a13e-7baeff0ff82c/Attachments/10669694-10606864-1.PDF>.
- [27] Energinet & Danish Energy Agency, Technology Data for Energy Plants for Electricity and District Heating Generation; Technology Data for Energy Storage, 2019. <https://ens.dk/en/our-services/projections-and-models/technology-data>.
- [28] Consoglobe, A Cherbourg, on se chauffe à l'eau de mer (In Cherbourg, we heat with seawater), (2012). <http://www.consoglobe.com/cherbourg-chauffe-eau-de-mer-cg> (accessed June 27, 2019)
- [29] Ville de La Seyne-sur-Mer, L'eau de mer est une source d'énergie : La Seyne-sur-Mer l'utilise avec des échangeurs thermiques (Seawater is a source of energy: la Seyne-sur-Mer uses it with heat exchangers), n.d. <https://var.eelv.fr/wp-content/blogs.dir/64/files/2012/01/2012-01-16-ECHANGEURS-THERMIQUES-LA-SEYNE.pdf>
- [30] EHPA, Large scale heat pumps in Europe, 2017. https://www.ehpa.org/fileadmin/red/03._Media/03.02_Studies_and_reports/Large_heat_pumps_in_Europe_MDN_II_final4_small.pdf
- [31] Energinet, Energinets analyseforudsætninger (Assumptions for analysis), 2017. <https://energinet.dk/Analyse-og-Forskning/%0AAanalyseforudsætninger/Analyseforudsætninger-2017>
- [32] G. Venturini, A. Pizarro-Alonso, M. Münster, How to maximise the value of residual biomass resources: The case of straw in Denmark, *Appl. Energy.* 250 (2019) 369–388. <http://doi.org/10.1016/j.apenergy.2019.04.166>
- [33] Københavns Kommune, CO₂ - regnskab for 2018. Kortlægning for kommunen som samfund (CO₂ accounts for 2018. Mapping for the the City of Copenhagen), (2019). https://kk.sites.itera.dk/apps/kk_pub2/pdf/1982_9f0232cfe634.pdf
- [34] D.M. Sneum, E. Sandberg, Economic incentives for flexible district heating in the Nordic countries, *Int. J. Sustain. Energy Plan. Manag.* 16 (2018) 27–44. <http://doi.org/10.5278/ijsepm.2018.16.3>
- [35] P.A. Østergaard, P.C. Maestoso, Tools, technologies and systems integration for the Smart and Sustainable Cities to come, *Int. J. Sustain. Energy Plan. Manag.* 24 (2019). <http://doi.org/10.5278/ijsepm.3450>



Low-temperature district heating networks for complete energy needs fulfillment

Maria Alessandra Ancona*, Michele Bianchi, Lisa Branchini, Andrea De Pascale, Francesco Melino and Antonio Peretto

Università di Bologna – DIN, Viale del Risorgimento 2, 40136 Bologna, Italy

ABSTRACT

In order to reduce fossil fuels consumption and pollutant emissions, high contribution is given by district heating. In particular, the integration with renewable energy may lead to a significant increase in energy conversion efficiency and energy saving. Further benefits can be achieved with low temperature networks, reducing the heat dissipations and promoting the exploitation of low enthalpy heat sources.

The aim of the paper is the analysis of the potential related to the conversion of existing district heating networks, to increase the exploitation of renewables and eliminate pollutant emissions in the city area. Further aim, in this context, is the optimization – from both energy production and operation management viewpoints – of a low temperature district heating network for the fulfillment of the connected users' energy needs. To this respect, a traditional network with a fossil fuel driven thermal production plant has been considered and compared with a low temperature district heating scenario, including geothermal heat pumps, photovoltaic panels and absorption chillers. These scenarios have been analyzed and optimized with a developed software, demonstrating the reduction of primary energy consumption and CO₂ pollutant emissions achievable with low temperature networks. In addition, a preliminary economic comparative evaluation on the variable costs has been carried out. Future studies will investigate the economic aspect also from the investment costs viewpoint.

Keywords:

District heating;
Optimization;
Low-temperature networks;
Thermodynamic analysis;
Energy saving;

URL: <http://doi.org/10.5278/ijsepm.3340>

1. Introduction

Recently, energy grids became a central issue for the achievement of the standards imposed by international regulations on environmental impact [1]. With this purpose, the integration between renewable generators and traditional production systems has been promoted [2, 3]. Relating to the thermal energy field, District Heating Networks (DHNs) are largely diffused [4, 5], allowing to reduce both pollutant and thermal emissions within the city area, as demonstrated for the case study of Great Copenhagen in [6]. In recent years, efficiency improvement has been reached thanks to the integration of DHN with Renewable Energy Sources (RES) [7] and

cogeneration units. In Europe, some instances of integrated thermal grids are present, considering the integration of different technologies with RES for the production of thermal energy [8, 9]. As an example, at the Delft University of Technology the 17% of thermal and cooling needs is currently provided by a system which includes CHP units, geothermal systems and aquifer thermal storage [10], allowing an energy saving equal to the 10%. Particularly, the positive effect of the introduction of heat pumps (HPs) in DHNs has been confirmed [11, 12].

Furthermore, low temperature district heating (DH) has been recently recognized as a viable solution to

*Corresponding author - e-mail: maria.ancona2@unibo.it

Acknowledgement of value

The study provides an original and innovative approach in the research field of low temperature district heating coupled with renewables. The strong novelty stands in the conversion of existing traditional district heating networks into low temperature networks completely avoiding the use of fossil fuels without reducing the energy service to final users. Furthermore, the proposed conversion allows also to fulfill the cooling energy without modifying existing networks. The approach represents a real action in the direction of reducing CO₂ emissions, dependency on fossil fuels and their use in the city area. Finally, this methodology increases the efficiency in the energy sector and represents a strategy to reduce the heating and cooling energy cost for users. All the advantages highlighted in the study are completely in line with the 2030 Agenda for Sustainable Development of European Commission.

Dr. Biagio Di Pietra, Senior Researcher, ENEA-UTEE (Technical Unit for Energy Efficiency)

further increase the energy efficiency in the heating sector [13]. The main advantages of low temperature DHNs stand both in the reduction of the heat losses through the network and in the efficiency increase for the production systems. In particular, renewable heat sources, such as HPs, geothermal systems, etc., can achieve important efficiency improvements if the temperature of the network is lowered [14]. As an example, it has been estimated that – with a reduction in DH supply/return temperatures from 80°C/45°C to 55°C/25°C – the coefficient of performance (COP) of industrial waste-based HPs can be increased from 4.2 to 7.1, while the cost of solar thermal can be reduced of about the 30 % [15, 16]. Currently, reductions in the temperature levels down to 10–20°C [17] are investigated in order to further decrease the heat dissipations through the network and exploit very low heat sources.

In this context, the innovative aspects of the study stand in the definition of a low temperature DHN, coupled with renewables, which enables to completely avoid fossil fuel consumption and pollutant emissions at a district/city level, guaranteeing the fulfillment of the whole thermal and cooling users' needs. Considering the will of converting existing DHNs without modifications in the heat emission systems of the final users, this result can be obtained thanks to the introduction of booster HPs: despite a consequent increase in the electricity consumption (partially covered by photovoltaic system), this set-up (low temperature DH + booster HPs) has been proven as a promising solution [18]. Finally, a preliminary economic evaluation on the variable costs has been carried out in this paper, while future studies will deeply investigate also the investment costs.

In detail, the structure of the manuscript is organized as it follows. In Section 2 the methodology applied for the analysis is discussed, highlighting the users' energy

needs, the considered scenarios and assumptions and describing the developed software used for the analysis. Instead, in Section 3 the results are presented and discussed, while in Section 4 the concluding remarks are highlighted.

2. Methodology

To evaluate the possibility of converting existing DHNs into low temperature DHNs for electrical, thermal and cooling energy fulfillment, a network composed by a centralized thermal production and three users of different typology has been considered. The hourly based energy needs profiles for each user has been evaluated for three typical days separately. Then, the Reference Case has been set, representative of a traditional network operation: the heat is produced by natural gas (NG) boilers and provided to the users via DH with temperature levels of 90°C/60°C (respectively for the supply and the return of the network), while the electrical and cooling needs are fulfilled by electricity purchase. The Reference Case has been compared with a low temperature DHN, in which the network is operated with temperature levels of 20°C/10°C, with a centralized geothermal system and providing heat to fulfill both the users' thermal and cooling needs, via HPs and absorption chillers respectively. In addition, photovoltaic (PV) panels are considered as decentralized production system. The optimization has been carried out with a developed software and preliminary economic evaluations have been assessed. In the following paragraphs, the methodology will be discussed.

2.1. Energy needs profiles

The electrical, thermal and cooling needs hourly profiles for the three typical days representative of winter, middle season and summer are shown in Figure 1 as

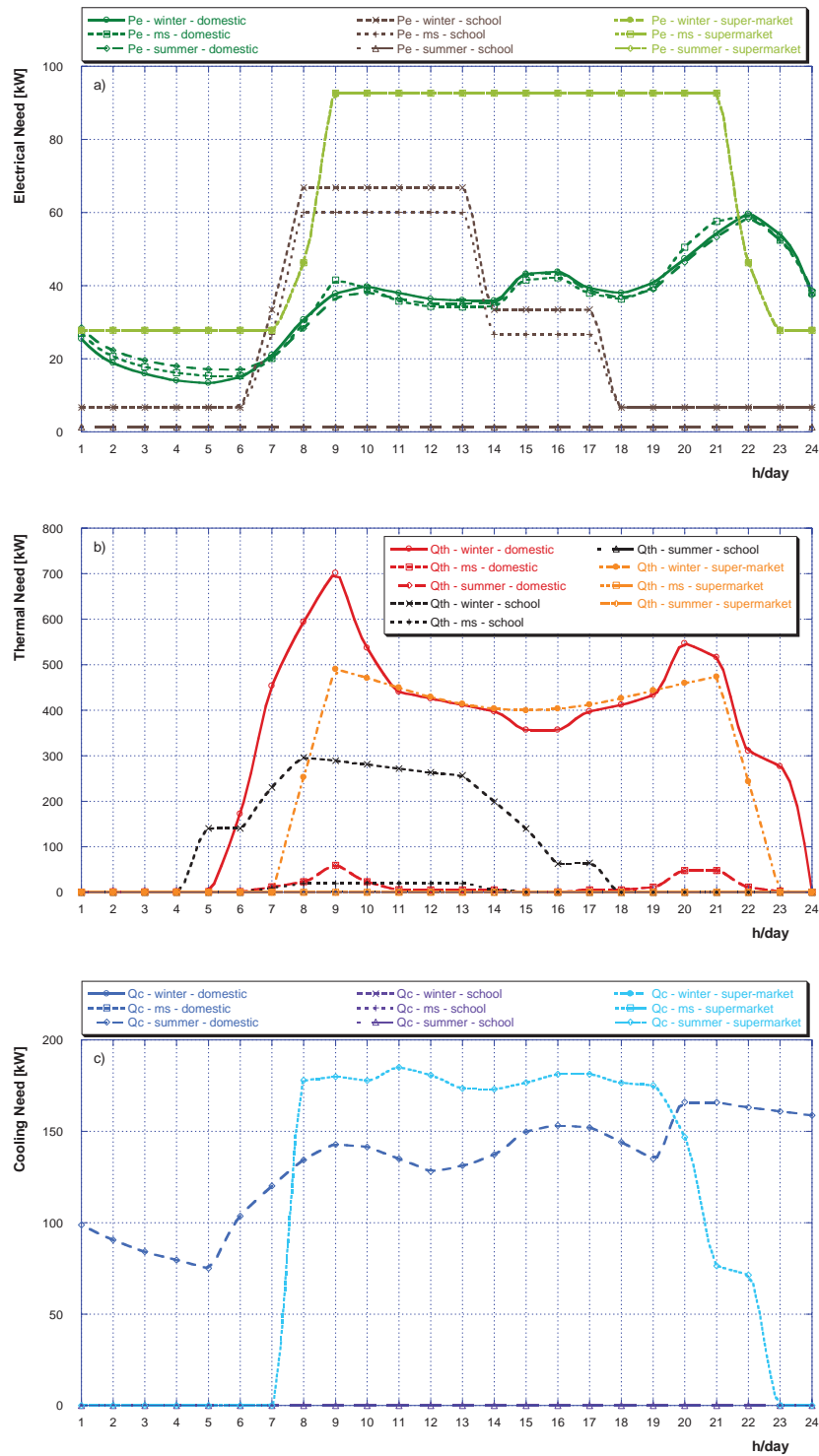

Figure 1: Users' needs as function of the user typology and of the considered typical day (winter, middle season – ms and summertime):
 a) electrical needs, b) thermal needs and c) cooling needs

function of the considered user typology (domestic user, school or supermarket). These curves has been determined on the basis of literature [19–24] and considering the following assumptions:

- domestic user: building composed by 83 apartments, each one with (i) a peak of electrical need equal to 0.65 kW_e , (ii) a peak of thermal need of 7.7 kW_{th} for space heating and

0.7 kW_{th} for hot water and (iii) a peak of cooling need of 2 kW_c. In addition, a peak of 12 kW_e has been considered for the lightening of the common areas of the building;

- school: peaks equal to 67 kW_e (for the electrical need) and equal to 276 kW_{th} and to 20 kW_{th} (for the thermal needs, space heating and hot water respectively). No cooling needs have been considered for the school, due to the summer closure;
- supermarket: peaks equal to 93 kW_e (electrical need), equal to 490 kW_{th} (thermal need, space heating only) and equal to 185 kW_c (cooling need).

In detail, Figure 1a shows the electrical needs profiles: the domestic user electrical need presents three peaks, while the lower request is registered during the night. Furthermore, for domestic users a slight increase in the electrical needs can be seen in middle season and summer with respect to winter season. As it regards the supermarket, instead, the same electrical need profile is registered for the three typical days, with a maximum constant request during the opening hours equal to around 93 kW_e. Finally, the electrical needs for the school present similar trends during winter and middle season, while a minimum constant request is considered during the summer closure for the maintenance of the installed appliances.

Relating to the thermal needs, for domestic users and school hot water and space heating needs are considered during winter, while only hot water is required during middle season and summer. On the other hand, for the supermarket only space heating needs are provided via DHN; consequently, no thermal needs are registered during middle season and summer.

Finally, for the domestic user and the supermarket, the cooling needs are present only during summertime, while no cooling need is considered for the school, due to summer closure.

2.2. Reference Case

As shown in the schematic of Figure 2a, to define a Reference Case, a traditional DHN has been considered for the fulfillment of the previously mentioned three users of different typology. Space heating and hot water needs are provided via DH, while each user provides by

itself for electrical and cooling needs by electricity purchase. The heat production occurs by means of NG boilers installed at the centralized thermal power station, characterized by a rated efficiency equal to 90 % and by a total rated thermal power equal to 1600 kW. The off-design behavior of the NG boilers has been modeled as presented in [25]. Furthermore, the network temperature levels have been assumed equal to 90°C and 60°C, respectively for the supply and the return lines.

As it regards the cooling needs, compression chillers installed at each user have been considered, with an Energy Efficiency Ratio (EER) equal to 4.

2.3. Low temperature DHN case

The proposed low temperature DHN scenario (Figure 2b) considers the presence of a geothermal source at the centralized thermal power station, which provides heat to the network allowing to reduce the temperature levels – with respect to the Reference Case – down to 20°C and 10°C, respectively for the supply and return pipes of the network.

As a consequence, due to the need of increasing the temperature level at the final users, for a correct operation of the current heating systems and to satisfy the hot water needs, the installation of HPs at each user has been considered. With this assumption, the temperature levels required by the user side circuit can be guaranteed. Furthermore, a COP equal to 3 has been assumed: indeed, even if geothermal HPs commonly achieve higher COP values [26], this assumption has been made as a mere precaution due to the high difference between the temperature levels of the condenser and of the evaporator of the HP. Instead, as it concerns the cooling needs, absorption chillers have been considered, fed by the outlet stream of the HP and assuming an EER equal to 0.67. Finally, the installation of PV panels at the final users is accounted: the peak power has been evaluated based on the solar irradiation data for the considered location (Bologna, North of Italy [27]) and on the available rooftop surface [27], considering (i) an occupancy factor of the 70 % (to allow installation and maintenance), (ii) a conversion efficiency equal to the 10 %, (iii) a tilt angle of 30° and (iv) an exposition to South. The electrical energy produced by the PV panels can be used to move the HP and/or to fulfill the electrical needs of

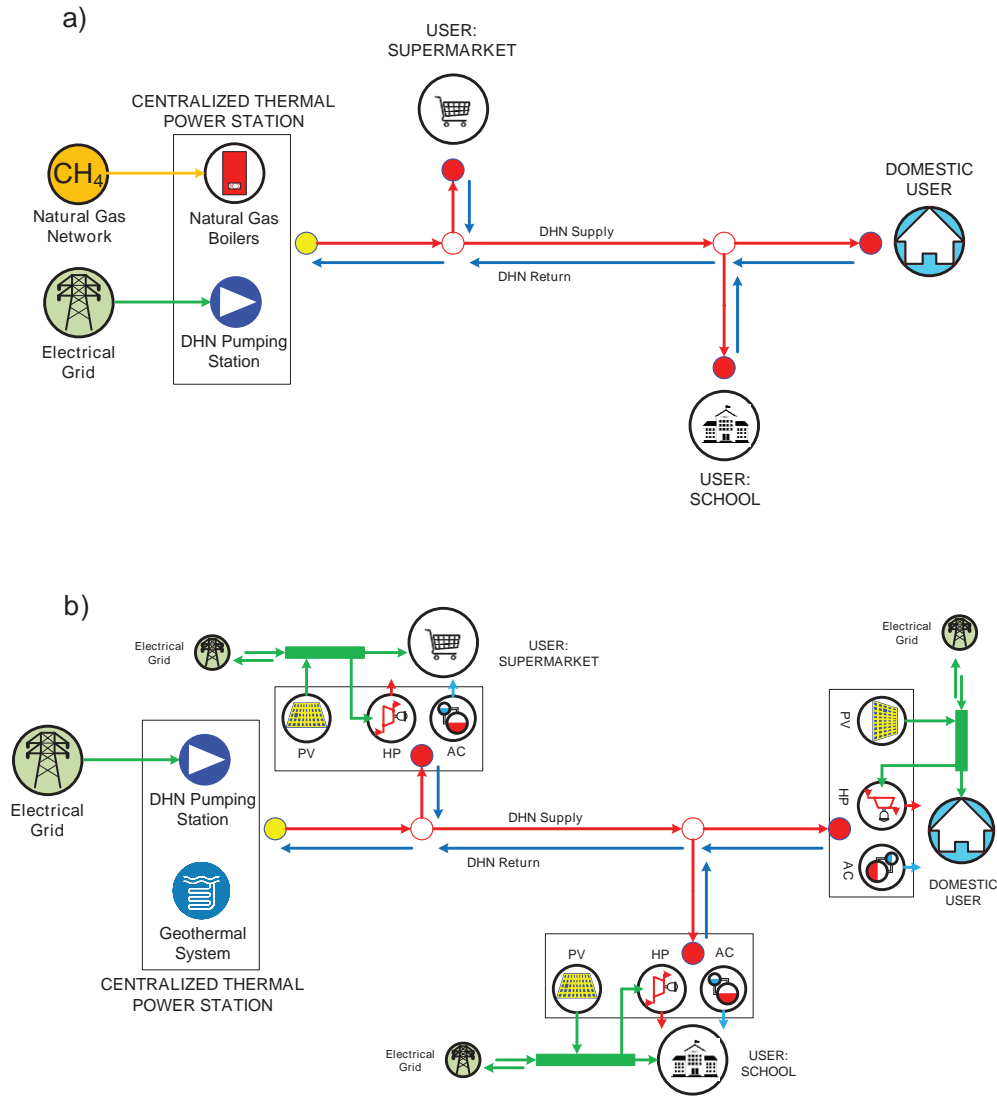

Figure 2: Schematic of the analyzed scenarios: a) Reference Case and b) Low temperature DHN case

the users. A connection with the national electric grid is obviously maintained.

2.4. Software 3-CENTO and preliminary economic analysis

The software 3-CENTO (electrical, thermal/cooling and fuel – Complex Energy Network Tool Optimizer) has been developed to optimize the design and operation of complex energy networks, including – eventually in smart configuration – electrical grids, DHNs and district cooling networks (DCNs). The software (see the flow-chart of Figure 3), on the basis of several inputs – related

to networks topology, users loads, energy systems typology and characteristics, economic tariffs, etc. – allows to optimize both the networks operation and the scheduling of the energy systems by the application of specific objective functions. In detail, the calculation core consists of two calculation models based on the Todini-Pilati [28] and genetic algorithms [29], for DHN/DCN operation and energy systems' scheduling optimization respectively.

In particular, once the calculation has been carried-out, for the DHNs the developed software evaluates:

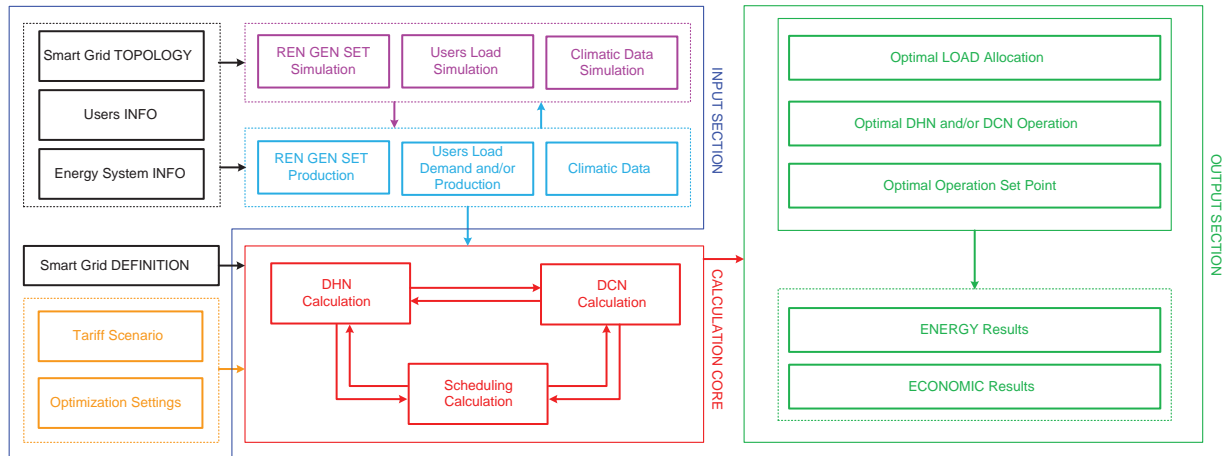

Figure 3: General schematic of the 3-CENTO software

- thermal energy to be produced at the centralized production plant;
- inlet and outlet temperature and pressure, mass flow rate, velocity and pressure drop for each pipe;
- electric power for the pumping station;
- pressure drops of the primary circuit of each users;
- heat losses through the network.

Furthermore, as a result of the software application, the energy systems optimal scheduling and design is calculated.

Based on the energy results obtained from the software, a preliminary economic analysis has been carried out for the evaluation of the annual cash flow (CF_i) related to the two compared scenarios, accounting for the costs of fuel and electricity purchase, as well as for the operation and maintenance costs of the energy systems:

$$CF_i = E_{fuel} \cdot c_{fuel} + E_e \cdot c_e + E_{th,B} \cdot c_{M,B} + E_{c,CC} \cdot c_{M,CC} + E_{th,HP} \cdot c_{M,HP} + E_{c,AC} \cdot c_{M,AC} \quad [€]$$

being:

- E_{fuel} yearly fuel consumption of the plant [kWh/y];
- c_{fuel} specific cost of the fuel (NG);
- E_e yearly electricity purchase [kWh/y];
- c_e specific cost of electricity;
- $E_{th,B}$ thermal energy yearly produced by the NG boilers [kWh/y];
- $c_{M,B}$ maintenance specific cost of NG boilers, assumed equal to 0.005 €/kWh [30];
- $E_{c,CC}$ cooling energy yearly produced by the compression chillers [kWh/y];

- $c_{M,CC}$ maintenance specific cost of compression chillers, assumed equal to 0.006 €/kWh [30];
- $E_{th,HP}$ thermal energy yearly produced by the HPs [kWh/y];
- $c_{M,HP}$ maintenance specific cost of HPs, assumed equal to 0.010 €/kWh [30];
- $E_{c,AC}$ cooling energy yearly produced by the absorption chillers [kWh/y];
- $c_{M,AC}$ maintenance specific cost of absorption chillers, assumed equal to 0.002 €/kWh [30].

Since c_{fuel} and c_e strongly depend from the considered Country, three different hypothesis in terms of c_{fuel}/c_e ratio have been accounted: 0.5 (corresponding to the Italian values, 0.087 €/kWh for the NG and 0.180 €/kWh for the electricity), 0.3 and 0.7.

3. Results and discussion

The yearly energy results obtained for the proposed scenarios are presented in Figure 4 and in Figure 5. In detail, both for the Reference Case and for the Low temperature DHN case, two off-design operation strategies have been considered and evaluated, respectively maintaining constant (at the design value) the mass flow rate through the network or the temperature difference between the supply and the return of the network. In Figure 4 the yearly fuel consumption and electricity purchase of the proposed scenarios are shown. As it can be seen, for the Reference Case a yearly fuel consumption equal to around 3900 MWh/y and to about 3700 MWh/y is registered, respectively in case of constant mass flow rate and in case of constant temperature difference off-design management strategies. On the

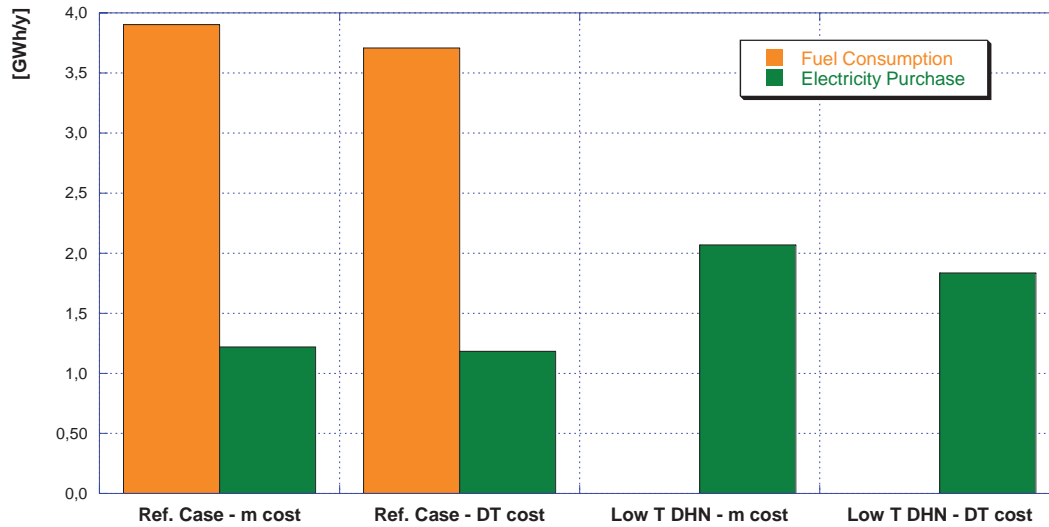

Figure 4: Annual fuel consumption and electricity purchase for the proposed scenarios (Ref. Case, Low temperature DHN) and for the evaluated off-design management strategies (constant mass flow rate or temperature difference)

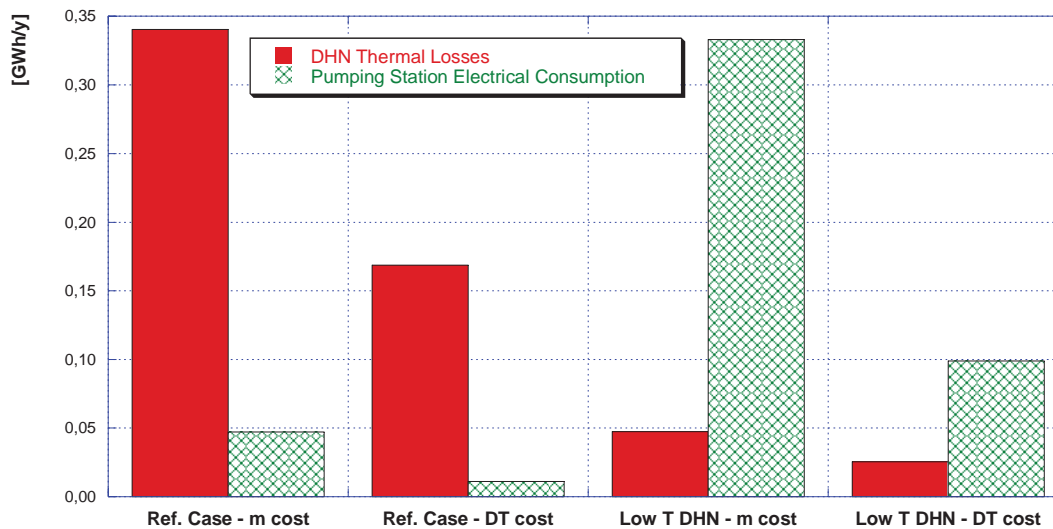

Figure 5: Annual thermal losses through the network and electricity consumption of the pumping station for the proposed scenarios (Ref. Case, Low temperature DHN) and for the evaluated off-design management strategies (constant mass flow rate or temperature difference)

contrary, the proposed low temperature scenario – by the exploitation of a geothermal source – allows to completely avoid the fossil fuel consumption at the district area, with the consequent elimination of the related pollutant emissions. In particular, considering an emission factor equal to $0.198 \text{ kgCO}_2/\text{kWh}_{\text{CH}_4}$ for the NG, a total emission ranging from 735 to 773 tonCO_2/y (depending on the off-design strategy) can be locally avoided during a year. This result is particularly interesting to promote environmental sustainability and to

increase the life quality at the city areas. On the other hand, evidently, an increase in the electricity purchase is registered during the year for the low temperature case (see Figure 4), mainly due to the introduction of the HPs employed to provide both the thermal needs of the users and the heat required by the absorption chillers. However, this increase is limited thanks to the PV panels installation, which allow a production of around 600 MWh/y of electric energy. In more detail, the PV production covers the 22 % and the 24 % of the annual total request of

electricity respectively for the case with constant mass flow rate and with constant temperature difference off-design management strategies. Furthermore, the comparative evaluation, between the Reference Case and the Low temperature case, of the total annual fuel consumption – composed by a contribution attributable to the centralized production plant (*i.e.* the annual fuel consumption shown in Figure 4) and by the amount of fuel consumed to generate the electrical energy purchased from the national electrical grid – confirms a reduction ranging from the 26 % to the 34 %, obtainable for the Low temperature scenario. To this respect, in order to evaluate the fuel amount for the electricity production, the mean efficiency value for the Italian power generation plants has been considered (40.2 %) [31]. As a consequence, an overall reduction in the CO₂ equivalent emissions ranging from 355 to 414 tonCO₂/y (depending on the off-design considered strategy).

As it regards the DHN operation, Figure 5 shows the yearly thermal losses through the network and the annual electrical consumption of the pumping station. As it can be seen, the thermal losses are importantly reduced by the decrease of the network temperature levels: being equal for the two cases the off-design strategy, indeed, a thermal losses reduction of around the 85 % can be achieved with the Low Temperature DHN scenario. On the other hand, the reduction in the temperature difference between the supply and the return of the network leads to an increase in the mass flow rate through the network, from a value of around 12 kg/s

(Reference Case) to a value equal to about 24 kg/s (Low Temperature DHN scenario). As a consequence, the electrical consumption of the pumping station results importantly increased (see Figure 5) especially when the constant mass flow rate strategy is adopted for the off-design operation. In addition, an increase in the network supply pressure is required for the Low Temperature DHN scenario with respect to the Reference Case. In particular, the 3-CENTO software has enabled to evaluate the optimal supply pressure for the correct network operation, which allows to guarantee a minimum pressure drop equal to 0.5 bar in correspondence of the user located at the end of the critical path (*i.e.* the path from the centralized production plant to the user with the highest pressure losses). The resulting optimal supply pressures are equal to 8 bar for the Reference Case and to 18.5 bar for the Low Temperature DHN scenario.

Finally, the results of the preliminary economic analysis are presented in Figure 6 in terms of annual cash flow, as function of the ratio c_{fuel}/c_e . As it can be seen, the Low Temperature scenario always allows to reduce the annual costs to be sustained for the energy production and network’s operation and maintenance. In detail, the annual costs reduction ranges from the 5 % to the 47 % (depending on the ratio c_{fuel}/c_e). To this respect, it should be highlighted that the investment costs for the conversion of a traditional DHN into a low temperature network are quite high. As a consequence, even if the environmental advantages have been demonstrated in this study, incentives for the installation of renewable

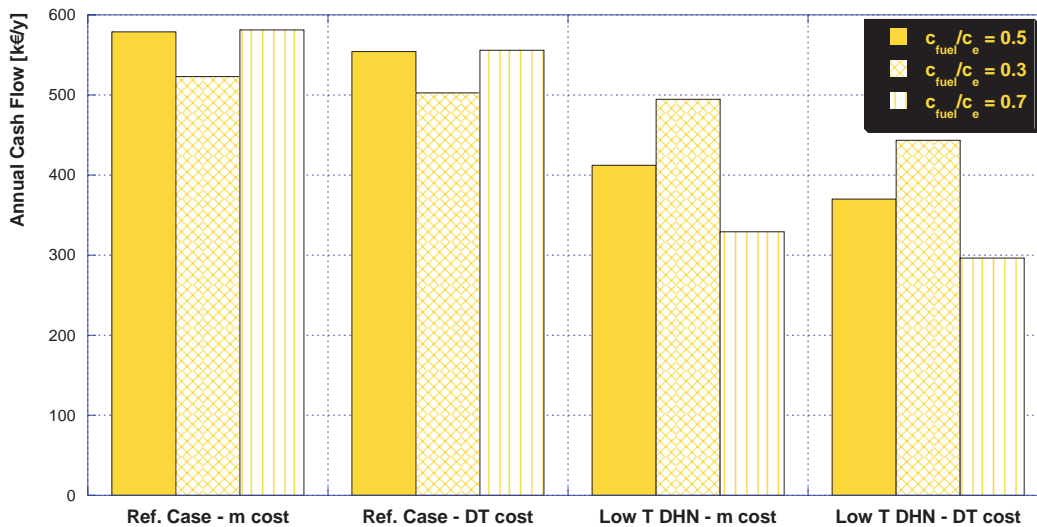

Figure 6: Annual cash flow (costs sustained for energy production and network’s operation and maintenance) for the proposed scenarios and for the evaluated off-design management strategies as function of the ratio c_{fuel}/c_e .

generators and carbon taxes related to the pollutant emissions should be considered, to make the proposed solution economically viable. Furthermore, the economic convenience is strongly affected by the ratio between the costs of the NG and of the electricity. To this respect, a greater convenience can be achieved in a perspective in which – thanks to the increase in the RES penetration for electricity production – the price of NG is expected to increase while the price for electricity purchase is supposed to decrease.

4. Concluding remarks

To promote primary energy saving and pollutant emissions reduction, in this study a low temperature DHN scenario has been proposed for the fulfillment of the connected users' energy needs. The low temperature DHN operates with supply and return temperatures equal to 20°C and 10°C respectively and includes RES (geothermal and photovoltaic), HPs and absorption chillers. This scenario has been compared – in terms of primary energy consumption, network's thermal losses and pumping consumption, annual cash flows – with a traditional DHN with NG boilers as energy production systems, operating at 90°C/60°C. The results show that the proposed low temperature scenario allows to completely avoid the fossil fuel consumption at the district area, with the consequent elimination of the related pollutant emissions. In addition, even if the yearly electricity purchase is increased due to the HPs installation, the total annual fuel consumption – calculated as the sum of the fuel locally consumed and the amount of fuel consumed to generate the electrical energy purchased from the national electrical grid – results decreased by a value ranging from the 26 % to the 34 %. Further advantages can be achieved for the network operation, since the low temperature DHN scenario enables to importantly reduce (85 %) the heat losses through the network. Finally, the low temperature scenario allows to reduce the annual costs to be sustained for the energy production and network's operation and maintenance (29-33 % of reduction). Evidently, due to the quite high investment costs related to the DHN conversion, incentives for the installation of renewable generators and carbon taxes related to the pollutant emissions should be considered.

Acknowledgements

This article was invited and accepted for publication in the EERA Joint Programme on Smart Cities' Special

issue on *Tools, technologies and systems integration for the Smart and Sustainable Cities to come* [32].

References

- [1] Heinisch V, Göransson L, Odenberger M, Johannson F. A city optimisation model for investigating energy system flexibility. *Int J Sustain Energy Plan Manag* 2019;24. <http://doi.org/10.5278/ijsepm.3328>.
- [2] International Energy Agency. Renewable energy medium-term market report 2014 – market analysis and forecast to 2020. Paris, France; 2014. www.iea.org
- [3] Directive 2009/28/EC of the European Parliament and of the Council of 23 April 2009 on the promotion of the use of energy from renewable sources and amending and subsequently repealing Directives 2001/77/EC and 2003/30/EC (Text with EEA relevance). <https://eur-lex.europa.eu/legal-content/IT/ALL/?uri=CELEX%3A32009L0028>
- [4] Connolly D, Lund H, Mathiesen BV, Werner S, Möller B, Persson U, et al. Heat roadmap Europe: combining district heating with heat savings to decarbonize the EU energy system. *Energy Policy* 65 (2014) 475–489. <https://doi.org/10.1016/j.enpol.2013.10.035>
- [5] Østergaard PA, Lund H. Smart District Heating and Electrification. *Int J Sustain Energy Plan Manag* 12 (2017) 1-4. <https://doi.org/10.5278/ijsepm.2017.12.1>
- [6] Ben Amer S, Bramstoft R, Balyk O, Nielsen PS. Modelling the future low-carbon energy systems - a case study of Greater Copenhagen, Denmark. *Int J Sustain Energy Plan Manag* 2019;24. <http://doi.org/10.5278/ijsepm.3356>.
- [7] Margaritis N, Rakopoulos D, Mylona E, Grammelis P. Introduction of renewable energy sources in the district heating system of Greece. *Int J Sustain Energy Plan Manag*, 4 (2014) 43-55. <https://doi.org/10.5278/ijsepm.2014.4.5>
- [8] Böttger D, Götz M, Lehr N, Kondziella H, Bruckner T. Potential of the power-to heat technology in district heating grids in Germany. *Energy Procedia*, 46 (2014) 246–253. <https://doi.org/10.1016/j.egypro.2014.01.179>
- [9] Sartor K, Quoilin S, Dewallef P. Simulation and optimization of a CHP biomass plant and district heating network. *Applied Energy*, 2014;130:474–83. <https://doi.org/10.1016/j.apenergy.2014.01.097>
- [10] Schmidt RF, Fevrier N, Dumas P. Smart cities and communities, key to innovation integrated solution – smart thermal grids; 2013. http://www.rhc-platform.org/fileadmin/2013_RHC_Conference/Presentations/Tuesday_23rd_April/Session_G/1/Philippe_Dumas_Smart_cities_-_Solution_Proposal_Smart_thermal_grid.pdf.
- [11] Ommen T, Markussen WB, Elmegaard B. Heat pumps in combined heat and power systems. *Energy*, 76 (2014) 989–1000. <https://doi.org/10.1016/j.energy.2014.09.016>

- [12] Bach B, Werling J, Ommen T, Münster M, Morales JM, Elmegaard B. Integration of large-scale heat pumps in the district heating systems of Greater Copenhagen. *Energy*, 107 (2016) 321–334. <https://doi.org/10.1016/j.energy.2016.04.029>
- [13] Schmidt D. Low Temperature District Heating for Future Energy Systems. *Energy Procedia*, 149 (2018) 595-604. <https://doi.org/10.1016/j.egypro.2018.08.224>
- [14] Lund H, Werner S, Wiltshire R, Svendsen S, Thorsen JE, Hvelplund F, Mathiesen BV. 4th Generation District Heating (4GDH): integrating smart thermal grids into future sustainable energy systems. *Energy*, 68 (2014) 1–11. <http://dx.doi.org/10.1016/j.energy.2014.02.089>
- [15] Østergaard DS, Svendsen S. Costs and benefits of preparing existing Danish buildings for low-temperature district heating. *Energy*, 176 (2019) 718–727. <https://doi.org/10.1016/j.energy.2019.03.186>
- [16] Sarbu I, Sebarchievici C. Using Ground-Source Heat Pump Systems for Heating/Cooling of Buildings. *Advances in Geothermal Sciences*, Chapter 1. <http://dx.doi.org/10.5772/61372>.
- [17] Flexynets, 4th Generation District Heating Systems Webinar. <http://www.flexynets.eu/en/Media>.
- [18] Østergaard PA, Andersen AN. Booster heat pumps and central heat pumps in district heating. *Applied Energy*, 184 (2016) 1374-1388. <https://doi.org/10.1016/j.apenergy.2016.02.144>
- [19] Macchi E, Campanari S, Silva P. La microcogenerazione e gas naturale, 2005, Polipress, Milano
- [20] Commission of the European Communities. DEMAND-SIDE MANAGEMENT –end-use metering Campaign in 400 households of the European Community Assessment of the Potential Electricity Savings – Project EURECO; January 2002. www.eerg.it/resource/pages/it/Progetti_-_MICENE/finalreporteureco2002.pdf
- [21] Bianchi F, Altomonte M, Cannata ME, Fasano G. Definizione degli indici e livelli di fabbisogno dei vari centri di consumo energetico degli edifici adibiti a scuole - consumi energetici delle scuole primarie e secondarie, Report RSE/2009/119. <https://iate.europa.eu/entry/result/1153847>
- [22] UNI/TS 11300, Prestazione energetica degli edifici - Calcolo del fabbisogno di energia per il riscaldamento e il raffrescamento
- [23] UNI EN ISO 7730, Ergonomia degli ambienti termici – Determinazione analitica e interpretazione del benessere termico mediante il calcolo degli indici PMV e PPD e dei criteri di benessere termico locale.
- [24] Arteconi A, Brandoni C, Polonara F. Distributed generation and trigeneration: Energy saving opportunities in Italian supermarket sector. *Applied Thermal Engineering*, 29 (2009) 1735–1743. <http://doi.org/10.1016/j.applthermaleng.2008.08.005>
- [25] Ancona MA, Baldi F, Bianchi M, Branchini L, Melino F, Peretto A, Rosati J. Efficiency Improvement On a Cruise Ship: Load Allocation Optimization. *Energy Conversion and Management*, 164, (2018) 42-58. <https://doi.org/10.1016/j.enconman.2018.02.080>
- [26] Deng J, Wei Q, Liang M, He S, Zhang H. Field test on energy performance of medium-depth geothermal heat pump systems (MD-GHPs). *Energy and Buildings*, 184 (2019) 289–299. <https://doi.org/10.1016/j.enbuild.2018.12.006>
- [27] Ancona MA, Branchini L, De Pascale A, Melino F, Di Pietra B. Renewable Energy Systems Integration for Efficiency Improvement of a CHP Unit. Proceedings of ASME Turbo Expo 2017: Turbomachinery Technical Conference and Exposition GT2017 June 26-30, 2017, Charlotte, NC, USA. <http://doi.org/10.1115/GT2017-64193>
- [28] Todini E. Towards Realistic Extended Period Simulations (EPS) In Looped Pipe Networks. Proc. 8th Annual Int. Symp. On Water Distribution Systems Analysis, ASCE, Reston, VA; 2006.
- [29] Ancona MA, Bianchi M, Branchini L, De Pascale A, Melino F, Peretto A. Generation Side Management In Smart Grid in Proceedings of ASME-ATI-UIT Conference. Naples, May 17-20th, 2015.
- [30] Ancona MA, Bianchi M, Branchini L, De Pascale A, Melino F, Peretto A, Rosati J. Combined Heat and Power Generation Systems Design for Residential Houses. *Energy Procedia*, 158 (2019) 2768-2773. <https://doi.org/10.1016/j.egypro.2019.02.036>
- [31] <http://data.enel.com>
- [32] Østergaard PA, Maestoso PC. Tools, technologies and systems integration for the Smart and Sustainable Cities to come. *Int J Sustain Energy Plan Manag* 2019;24. <http://doi.org/10.5278/ijsepm.3450>.



International Journal of Sustainable Energy Planning and Management

RESEARCH and EXPERIMENTATION

Simulation of an alternative energy system for district heating company in the light of changes in regulations of the emission of harmful substances into the atmosphere

Maciej Widziński^{a,1}, Patryk Chaja^a, Anders N. Andersen^{bc}, Marta Jaroszewska^a, Sebastian Bykuć^a and Jakub Sawicki^a

^a Department of Distributed Energy, Institute of Fluid-Flow Machinery Polish Academy of Sciences, ul. Fiszera 14, Gdansk, Poland

^b Department of Planning, Aalborg University, Rendsburggade 14, 9000 Aalborg, Denmark,

^c EMD International A/S, Niels Jernes Vej 10, 9220 Aalborg Ø, Denmark

ABSTRACT

In recent years, Poland has been going through many changes, also within energy generation and the legal and regulatory system. According to the EU 2020 Climate and Energy Package, in the nearest future the Polish energy industry, will have to significantly modernize most of its power plants. The dynamically changing situation results in higher demand for various analysis (concerning both energy and economic aspect) helping with setting the frames for the future functioning of power engineering companies. One of the Polish power companies, PEC Legionowo, is reshaping its infrastructure to meet the new requirements and from this particular company, authors are using the acquired data for the test case. The first conceptual project related to the development of the PEC Legionowo energy system is currently being realized in terms of increasing its energy efficiency and reducing harmful exhaust emissions. Because PEC Legionowo is obligated to significantly reduce emissions by 2022, they are seriously considering reducing coal-based production. The resulting energy gap is planned to be covered by among others installing high-efficiency combined heat and power (CHP) systems.

This article analyzes and verifies the model of an existing CHP plant and checks the modernization possibilities of the existing installation in terms of reducing emission. The new installation of gas boilers designed to replace coal-fired boilers is being validated, to meet the new emission requirements while still meeting the demand for heat and electricity.

For modelling a test case, the combined techno-economic optimization and analysis software energyPRO is used. The software optimizes the operation of the modeled system according to all input conditions, such as generation and economic data obtained from a functioning CHP plant in the Polish industry.

The results show the quantitative and economic difference related to the introduced changes in the heat and power plant system. The analysis also focuses on the size of the investment outlay and the return time of the project.

Keywords:

*District heating;
Energy system analyses;
energyPRO;
Climate and Energy Package;*

URL: <http://doi.org/10.5278/ijsepm.3354>

1. Introduction

Energy systems around the world are constantly undergoing changes. You can even say it is revolution. This effect

is intimately linked to the changing conditions associated, first of all, with energy demands, accessibility of the energy resources and the introduction of EU environmental directives. When the world was overwhelmed by the

*Corresponding author - e-mail: maciej.widzinski@imp.gda.pl

Acknowledgement of value

The Polish energy sector is currently facing many challenges. Like many other energy companies, we are obliged to meet the relevant standards and parameters in energy production. Changes occurring in law, resulting mainly from changes at the European Union level, cause that many energy companies must undergo changes in infrastructure that will allow to meet the required standards for increasing energy efficiency and reducing emissions of harmful substances, and. However, one cannot forget about the economic aspect of these changes. The effects of the work described in this article are very valuable to us and will allow us to develop appropriate strategies for heating companies in the face of changes in legal regulations.

Dariusz Wojtas, Chairman of the Board of Municipal Thermal Energy Company in Ostrowiec Świętokrzyski, Poland.

Abbreviations and Nomenclature

BAT	Best available techniques	EU	European Union
BAT-AELs	Emission levels associated with the Best Available Techniques	GB	Gas boiler
CB	Coal boiler	HCl	Hydrochloric acid
CHP	Combined heat and power	HF	Hydrogen fluoride
DHC	District heating company	RES	Renewable energy sources

industrial revolution, coal became the main energy medium, which remains in many countries of the world to this day. In Poland, coal is the primary fuel and constitutes over 80% of the energy mix. The current state of the energy fuel market is changing rapidly. Constant turbulence of fossil fuel prices can indicate that mankind has started to look for other alternative sources of energy. In Europe, Denmark is the leader of a new approach to energy systems, which in most cases is based on wind energy generation. Despite numerous objections, especially from the coal lobby, the Polish economy is undergoing transformation [1]. Although there are no proper meteorological conditions to effectively increase the share of RES, Poland strives to achieve the level of the most ecologically developed economies in Europe. Numerous economic reforms have bypassed the energy sector, and that left to its own has experienced stagnation. The lack of investment in previous years has led to a sudden need for reform in order to adapt large power plants to the requirements of EU directives [2].

Undoubtedly an important role in the process of energy transformation will be played by scientific entities that have been conducting research on this subject for many years. Numerous scientific papers have been written describing working conditions, simulation, optimization and maintenance of district heating systems. One of the

papers describing a wide range of heating (and cooling) systems is a review article by Werner [3] describing the state of heating and cooling systems, with particular emphasis on European countries. Lund et al. [4] take a deeper perspective and examine the state and level of fourth generation district heating, as well as describe the role of new technologies for district heating in future intelligent energy systems. Kontu et al. [5] examine the role and potential of using large scale heat pumps in existing district heating systems as well as try to understand the point of view of district heating companies on the potential of installing heat pumps in the system.

Different strategies for decarbonisation scenario for combined heat and power plants are presented by Popovski et al. [6] The work focus heat and power plants working on coal, and that is of really big importance for Poland to introduce decarbonisation scenarios.

Kazagic et al. [7] with the use of energyPRO perform the optimization of operation of district heating companies based on heat and power production units and renewable sources.

Optimization of a combination of heat and power plants with thermal stores is described by Fragaki et al. [8].

Østergaard et al. [9] point out that also the social and economic aspects of the operation of district heating systems are important. Economic aspect of the

operation of district heating plants is discussed by Fragaki et al. [10] on the case of heat and power plants in the UK.

Decarbonisation or designing future low-carbon [11] energy systems are not the only trends in improving the environmental situation. Ancona et al. [12] presents an approach of reduction in the consumption of fossil fuels and pollutant emissions by converting current heat distribution systems into low-temperature district heating systems.

Returning to modern energy systems, only scientific and technical analyses will allow for a harmonious transformation of the currently operating energy systems based on fossil fuels and will not reveal unnecessary costs incurred by investors and operators of this system. Special software is needed to work with simulation models. The authors' choice of energyPRO as a case study tool in this paper was determined by its worldwide character [13] and the fact that it is designed as a flexible tool for combined technical and economic optimization of different types of energy projects. It is also a widely used tool in research and it is easy to find work written based on EnergyPRO results covering the topic of simulation and optimization of district heating companies.

This article is devoted to the issue of energy transformation in the light of the implementation of EU directives, which Poland has been struggling with for several years. One of the first steps that the energy sector has to take in order to comply with the new regulations is

presented. The authors attempted to indicate potential directions of modernization of currently operating energy systems on the example of a heating company operating in Poland (combined heat and power plant).

2. Description of the power sector in Poland

In Poland, approximately 50% of heat demand is covered by district heating. The largest recipients of system heat are housing associations and housing communities as well as public utility buildings. The remaining heat demand is provided from individual sources or small local sources. For historical reasons, district heating systems were built in most Polish cities. As it is presented in Figure 1, Poland is one of the European leaders in the field of district heat.

The majority of heating companies in Poland are controlled by local government units. However, public ownership concerns mainly district heating systems in smaller cities.

District heating has become an important element of the energy sector due to the possibility of developing energy production from cogeneration, which national potential is estimated at 7-10 GW on the electricity side, depending on the technology. The district heating sector is shredded, and the development of cogeneration is possible in large units as well as smaller ones.

The production of district heating in Poland is based primarily on black coal, which comes from the fact that historically was the most accessible and cheapest fuel [14].

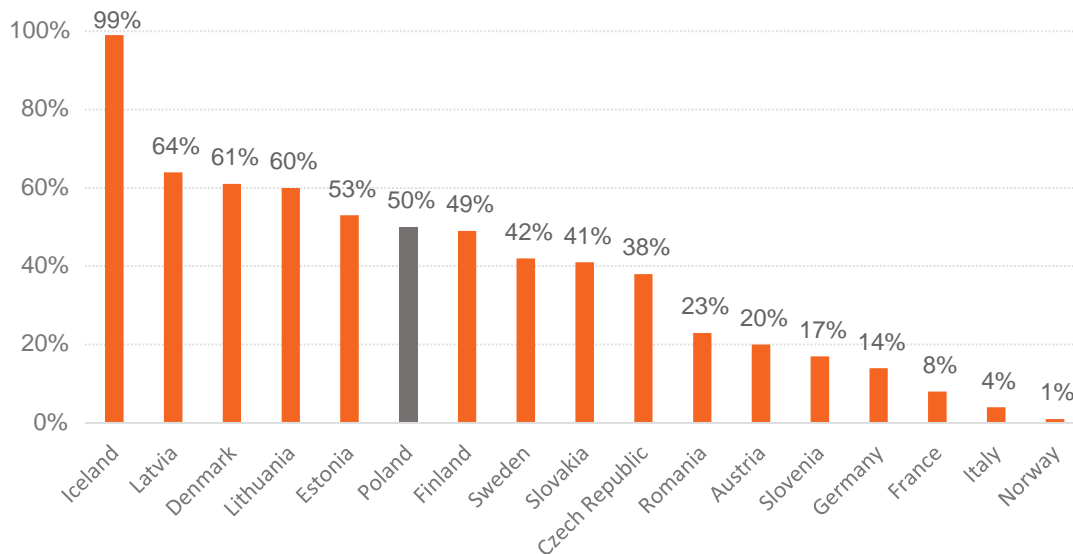

Figure 1: Share of heat covered by district heating in European countries [14]

Despite a slight decrease in the share of coal fuels in heat production - by 6.7 percentage points compared to 2002, in 2016 coal fuels still accounted for 75% of fuels consumed in heat sources. The share of renewable energy sources in 2016 in heat production increased by 4.7% compared to 2002 and amounted to 7.6% [14].

The diversification of fuels used for heat production was slightly higher in companies producing heat in the cogeneration process. In this group of enterprises, already 19% of consumed fuels are fuels other than coal, including 5.6% - heating oil, 7.2% - natural gas [14].

The development of heating systems allows eliminating the problem of low emission in many cities, which brings measurable savings in the field of medical expenses related only to the treatment of civilization diseases of the respiratory system. In 2016, over 71% of expenditures of heating enterprises were spent on investments in heat sources, the remaining part on distribution networks. The licensed heating companies funded those investments with own means.. In 2016, the share of internal funds in the financing of incurred expenditures amounted to over 70% of total spending.

The development of the district heating industry is still inhibited by the lack of legal regulations for linear heat system infrastructure. In 2015, the project of the so-called "corridor act" fell, which was to be replaced by the act on strategic public investment projects,

which, however, is not a solution for the legal status of district heating networks. This is not only a problem of new network investments but also for existing systems. Currently, in Poland, almost 80% of the network does not have a regulated legal status. Lack of regulation generates investment problems and maybe the reason for increasing heat prices for recipients (the cost of lawsuits).

In the current EU financial perspective for the years 2014–2020, the heating sector has limited possibilities of using public aid under regional aid. In this perspective only horizontal aid is possible, and for network investments, network upgrades, public aid is implemented only for systems that meet the condition of an effective heating system.

According to the definition in the Energy Efficiency Directive, an efficient heating and cooling system is one in which at least half of the energy comes from RES or waste heat, at least 75% of heat comes from cogeneration or 50% of heat coming from heat or cold production from the mix of the above-mentioned sources.

In Poland, about 10% of the largest heating companies meet these requirements, which means that the rest, that needs investment just as much, have no chance of obtaining any funds, even for the modernization of old networks not to mention the development of new ones. In Figure 2, heating companies with inefficient heating

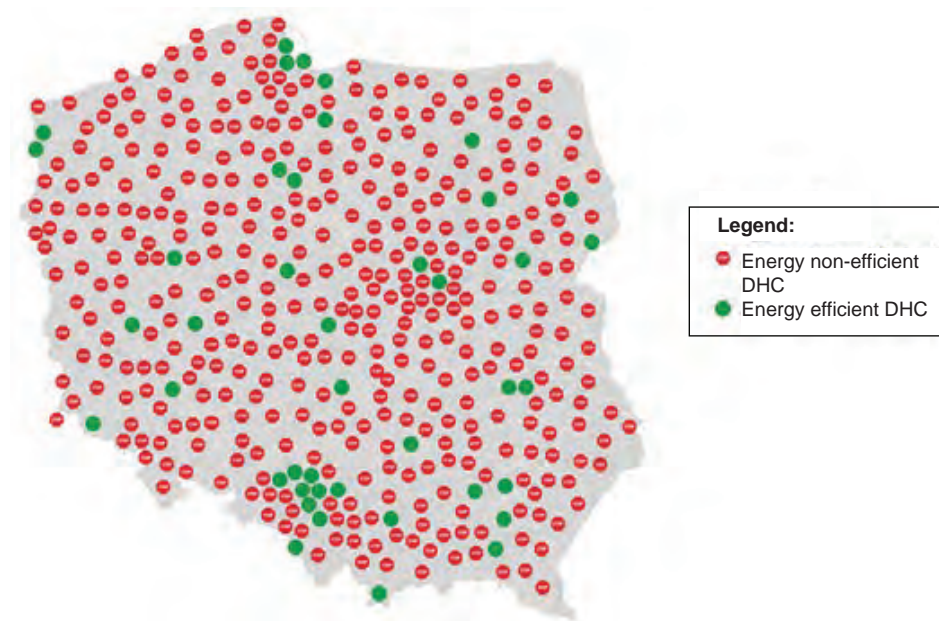

Figure 2: Energy-efficient DHCs in Poland [14]

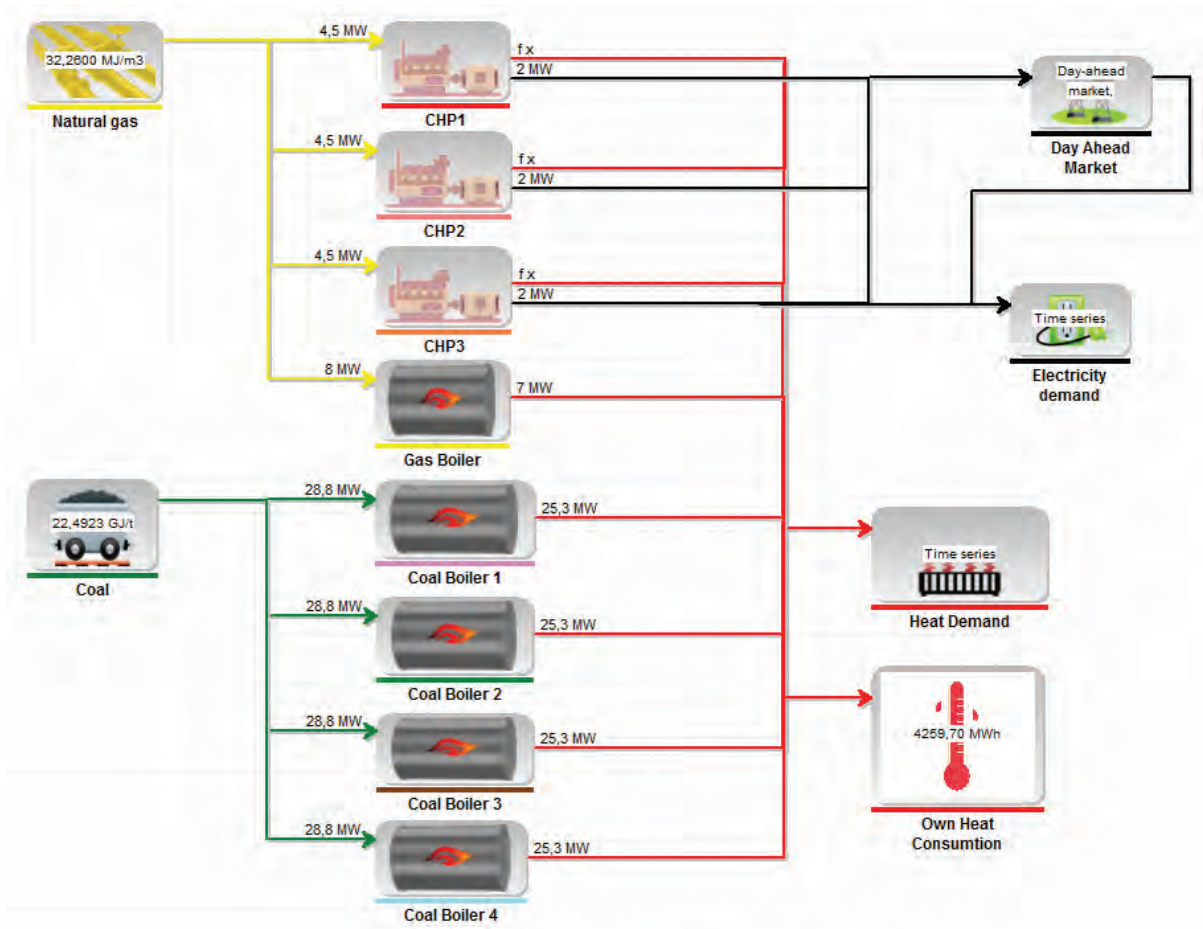

Figure 3: Structure of the DHC model consisting of three CHP engines, gas-fired boiler

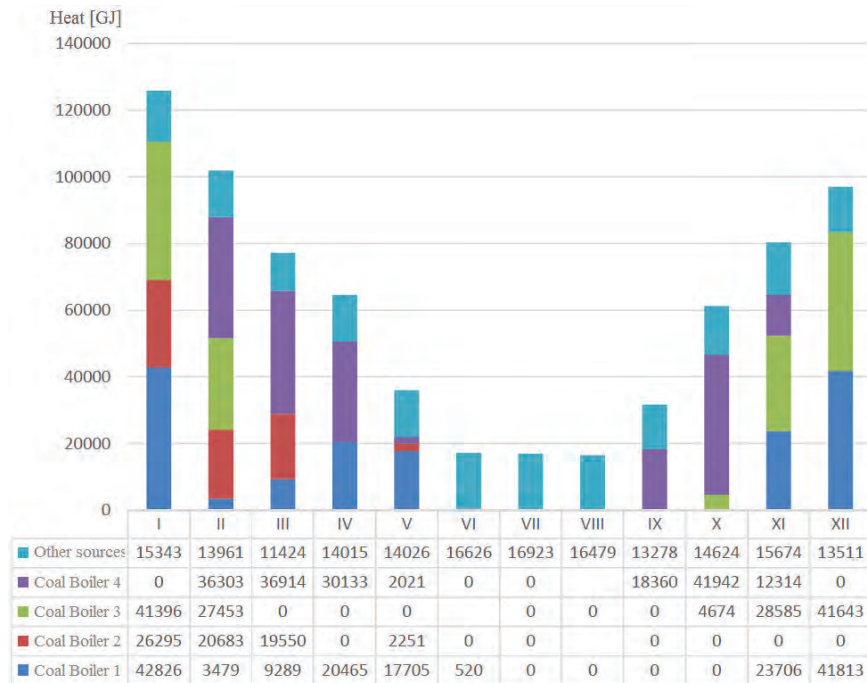

Figure 4: Overall heat production [GJ] during one year.

systems are marked in red, whereas the ones with efficient heating systems are marked in green.

3. Challenges for the energy sector and enterprises

The implementation of environmental regulations regarding the energy sector in the European Union member states indirectly affects the domestic heat engineering sector, as 75% of fuels used in Polish heating enterprises is black coal. In 2007, the European Union climate and energy package (so-called “3x20” package) was presented at the EU forum:

- a 20% reduction of greenhouse gas emissions,
- increase in the share of renewable energy sources (RES) in energy production by 20%,
- increasing energy efficiency by 20%.

Filling of commitments resulting from the climate and energy package was undertaken by the whole community of member countries and individual obligations were assigned to individual countries.

By the Directive of the European Parliament and the Council 2009/28/EC, Poland was obliged to achieve a minimum of 15% share of energy from renewable sources in final gross energy consumption, whereas according to the National Action Plan for renewable energy from 2010, Poland assumes that this share will increase to 15.85% by the end of 2020.

The perspective of further extension of these regulations is undoubtedly a significant threat to the domestic black and lignite mining sector, and thus to the heating sector. The new objectives of the European Union’s climate and energy policy for 2021-2030 are:

- reduction of greenhouse gas emissions in 2030, compared to 1990, by at least 40%,
- improvement of energy efficiency by 27%
- achieving at least a 27% share of renewable sources in total energy consumption.

In order to provide appropriate mechanisms to help achieve the objectives of the climate and energy package by 2020, a number of regulations have been introduced to implement the premises of the “3x20” package. The action aimed at meeting the greenhouse gas emission reduction target was the introduction of new regulations for the CO₂ emission allowance trading scheme (EU ETS). The current phase III of the system has introduced the need to reduce greenhouse gas emissions by 21% (by 2020) in relation to 2005.

A very important element in the context of the “new” EU rules are the so-called BATs which set for the standards for Best Available Techniques for large combustion plants in accordance with European Parliament and Council Directive 2010/75/EU, which have been published on 31 July 2017, The BAT conclusions refer to the combustion of fuels in installations with a total nominal thermal power of 50 MW or more, only if such activity takes place in combustion plants with a total nominal thermal power of 50 MW or more.

According to the above directive , the definition of a combustion plants reads: *“Any technical device in which fuels are oxidised in order to use the heat generated in this way. For the purpose of BAT conclusions, a combination of two or more separate combustion plants in the case where the exhaust gases are discharged through a common stack (...) is considered as one combustion plant. For the purpose of calculating the total rated thermal input of fuel of such a combination, the power of all individual combustion objects considered shall be added whose nominal thermal power in the fuel is at least 15 MW. “*

Classification of combustion plants/units depending on their total nominal thermal power delivered in the fuel:

- *“Where a part of a combustion plant discharging fumes with one or more separate pipes in a common chimney is used for less than 1500 hours/year, that part of the facility may be considered separately for the purposes of BAT conclusions. BAT-AELs (Emission levels associated with the best available techniques) apply to all parts of the structure in relation to the total rated thermal input applied to the fuel of this facility. In such cases, emissions from each of these wires are monitored separately. “*

The above-mentioned regulations are currently introducing a very big confusion on the heat and power plant heating market in Poland. Namely, they make the enterprises significantly reduce emission from solid fuels or switch to another type of fuel (eg. gas) by the end of 2022, in order to meet the goals indicated by the EU.

This article examines several variants of the statistical transition of a CHP plant in Poland to another type of energy system that meets the BAT conclusions.

4. Methods and Data

4.1. Simulation environment

For the modeling of a DHC test case the combined techno-economic optimization and analysis software energy-PRO was used. The software, developed by EMD International A/S, optimizes the operation of the modeled system in accordance to all input conditions such as generation and economic data, obtained from PEC Legionowo, a functioning heat and power plant in Polish industry. The optimization has been implemented by analyzing yearly data profiles on an hourly resolution.

4.2. DHC reference model

The simulation model was based upon an existing DHC power plant and consists of heat generation technology and electrical energy generation technology widely used across Poland. Figure 1 visualizes the entire system setup as it was implemented. The same structure was used for the simulation with values which are explained in the following subsections in detail. In the figure, black arrows represent electricity flows, whereas red arrows represent heat flow. Following generation units were implemented as a basic DHC system:

- Four stoker fired boilers type WR-25 with a total nominal capacity of 124 MWt. Two 32 MWt boilers based on RAFAKO units and two 30 MWt based on SEFAKO units, the average efficiency of 87% each,
- Three CHP engines based on Caterpillar type G3516H with 1.9 MW thermal capacity and 2.0 MW electric power and average efficiency of average 85% each [15],
- High temperature gas-oil boiler with thermal power of 8.0 MWt and efficiency 92.35%/92.66%. Working as a peak-reserve source for cogeneration engines. Based on HOVAL THW-I HT E unit [16].

Stoker fired boilers are supplied with fuel in the form of fine coal and 22.4923 GJ/t heat value. CHP engines and high-temperature gas-oil boiler are supplied with natural gas with a heat value of 32.26 MJ/m³.

4.3. Load profiles

Heat load profile, with an hourly resolution, was provided by an existing DHC power plant on which the model was based upon. The facility is responsible for meeting a heat demand of 198782.1 MWh/year

including 4259.7 MWh own use. It should be noted that DHC is an energy engineering enterprise operating in the field of electricity trading and distribution.

For Poland, it is common to use “Standardowe profile zużycia energii” [...] (standard load profiles), which are provided by Main Distribution System Operators for electricity load forecasting for municipal utilities or energy suppliers. Nevertheless, on behalf of this simulation external software and algorithm were used to generate electricity load profile.

The demand profile for electricity was prepared using the Artificial Load Profile Generator [17]. Based on the algorithm this tool calculates, the electric energy demand profile for a given number and types of households. In this algorithm, many variables are taken into account, including the number of people living in a given household, hours spent at home, working hours, number of appliances consuming electricity, etc. The number of households has an impact on the sum of energy demand, while the type of household affects the distribution. The received data is refreshed every minute, while for the purposes of this article, data was aggregated to refresh every hour. The authors, for the purpose of the analysis, assumed that the total demand is 22295 MWh, and 50% is generated by households run by families, 30% - two working people, and 20% - older people. The above methods of obtaining heat load profiles are only design methods using many variables. The best input data for implementation would be the one as comparable to real life data as possible, generated e.g. by using graph theory [18].

4.4. The economy of DHC reference model

Meeting EU standards is a necessary condition for the optimization issue, while the comparative aspect of the variance of the model is the economics of a given system, the size of investments and the company's revenue during the first year of the new system's operation. It is very important to point out that all economic data was obtained through cooperation with the heating energy enterprise. The values used in the model are as close as possible to the actual costs and profits per unit.

In the simulation model sale of electricity has been divided into two streams (Table 1). The first of them “Sale of el.en.” is the fulfillment of the energy demand that is provided to end-users. The second profit “Surplus electricity” refers to the profits resulting from the sale of

Table 1: Operation income revenues/expenditures pre-unit

	Value	Unit		Value	Unit
Revenues			Emissions		
Sale of heat	110	PLN/MWh	Emissions from coal		
Sale of el. en.		DAM	CO_coal	0.11	PLN/kg
Surplus electricity		DAM	SO ₂ _coal	0.53	PLN/kg
CHP propotion	40	PLN/MWh	NO _x _coal	0.53	PLN/kg
			Dust_coal	0.35	PLN/kg
			Soot_coal	1.47	PLN/kg
Opeating Expenditures			BaP_coal	381.36	PLN/kg
Purchase of gas	1.20	PLN/m ³	Emissions from gas		
GB maintenance cost	12000	PLN/unit/year	CO_gas	0.11	PLN/kg
Purchase of coal	330	PLN/t	SO ₂ _gas	0.53	PLN/kg
CHPs maintenance	137721	PLN/unit/year	NO _x _gas	0.53	PLN/kg
CBs maintenance	222063	PLN/unit/year	Dust_gas	0.35	PLN/kg
Grid Tariff	200	PLN/MWh			

excess produced electricity. For the sake of simplicity, both profits are calculated based on the Day-Ahead Market, however, they were separated to observe the ratio of profits.

Day-Ahead Market (DAM) is operating since June 30, 2000. It is a spot market for electricity in Poland. From the beginning of trading, prices on the Day-Ahead Market (DAM) are a reference for energy prices in bilateral contracts in Poland. DAM is intended for those companies that want to close their purchase/sale energy portfolios in an active and safe manner on a daily basis.

Within the electricity DAM, hourly and block contracts (base, peak and off-peak) are available. The changes on the DAM are currently presented by 6 price indices referring to the day and time of the delivery day. The latest electricity market index - TGe24 is the base instrument for contracts on the Financial Instruments Market (futures). It is determined by exchange transactions concluded on hourly products in the single-price auction system at the first auction on the DAM for electricity. Trading on the DAM is done for one and two days before the delivery period.

Until the end of 2018 In Poland, there was support for cogeneration plant operators. The Energy Regulatory Office in succession in 2016, 2017 and 2018 set out substitution charges referred in art. 9a paragraph 10 of the Energy Law Act, and in subsequent years amounted to 125 PLN/MWh in 2016, 120 PLN/MWh in 2017 and 115 PLN/MWh in 2018. At the beginning of 2019 funding for CHP technology ceased to apply. The current

plans of the Ministry of Energy provide support for cogeneration at the level of 40 PLN/MWh. This is an important factor that the authors used when designing one of the variants of the alternative system.

5. Heating enterprises adaptation

District heating companies fulfill an important role in the social and economic map of Poland, ensuring reliable and ecological delivery of heat and more often also electricity. Because of the needs of growing recipients and the local heating and energy market becoming more competitive, the main goal is a successive development of the companies and a further increase of their value. Simultaneously, district heating companies have to achieve commitments resulting from the climate and energy package and Best Available Techniques for large combustion plants. In the following, the analyzed system variants are presented.

5.1. Variant 1: Harmful substances reduction system

The first option assumes that all standards of BAT conclusions will be met by all four, based on fine coal heat sources. A considered variant would consist of construction works including dismantling current harmful substances reduction system (excluding the chimney) and building-up new devices in its place. The following variant would consist of disassembly of four current dust extraction systems, which do not meet the requirements, construction of four individual exhaust gas dedusting

systems (including complete pre-separators (MOS type), complete pulsing bag filters) and construction of four individual reduction systems: NO_x, SO₂, HCl, HF. In addition, each coal boiler would be equipped with reagent injection installation. The cogeneration system would be operated as before along with the gas boiler. Heat sources would work under the following regime shown in Figure 5: cogeneration engines operated throughout one year with an average use of 8500 h each. In the post-heating season as a peak source, a gas boiler would be used in a maximum level of 3000 h. However, during the heating season, along with the cogeneration system, the currently WR25 sources would be used. It should be borne in mind that simulated models are aimed at proposing possible solutions to meet EU directives while taking into account the need to reorganize the main elements of the current DHC system.

BAT standards for existing WR25 boilers after implementation of standards are presented in Table 2. Emission standards for existing cogeneration sources and an existing gas boiler with a dual-burner are presented in Table 3.

The dust extraction system uses electricity and compressed air at a rate of 170 kWh per hour of work per boiler. Assuming that in this variant total annual consumption would be 9500 h x 0.17 MW = 1615 MWh x 200 PLN/MWh = 323 000 PLN per operating year of the installation. Obviously assuming full boiler operation power and the full amount of exhaust. On average, it

gives 34 PLN per hour of work. The flue gas desulfurization installation uses reagent and electricity. Reagent costs 0.95 PLN/l (including transport), and consumption (for SO_x <200 mg / m²u) is about 17 dm³t of coal, which gives 16.15 PLN/t. Electricity consumption by pumps and auxiliary installations at the level of 15 kWh per hour of work, i.e. 0.015 MW x 9500 h x 200 PLN/MWh = 28 500 PLN. Coal-fired boilers in 2017 consumed 28 288 tons of coal, this means an annual cost of: 28 288 tons x 17 l/t x 0.95 PLN/l = 456 851 PLN/year plus 28 500 PLN of consumed electricity. On average, it gives 51.09 PLN per hour of work. In cooperation with DHC, it was established that the installation of a full harmful substances reduction system would cost about 7 million PLN.

5.2. Variant 2: Additional gas fired boiler

The option assumes achieving emission standards specified in the BAT conclusions by grouping and optimizing the working times of sources and the installation of a new generation unit. The new unit would be a 15 MWt boiler fired with natural gas. The Hoval boiler was used as the reference unit for the device model. The discussed variant does not assume discontinuation of any source of WR25 from operation. In a previous variant, coal-fired boilers were supposed to work with a regular timetable as shown in Figure 5. This variant assumes that coal-fired boilers will be peak sources, i.e. they will not be able to be operated for more than 1500 h per year. Due

Table 2: BAT standards for existing WR25 boilers

No.	Standard type	The annual average level in BAT for an existing source at power >100 MW & <300 MW	The daily average level in BAT for an existing source with a power of >100 MW & <300 MW
1	Increase overall environmental efficiency	None	None
2	NO _x , N ₂ O and CO emission reduction	NO _x 100-180 (mg/Nm ³)	NO _x 155-210 (mg/Nm ³)
3	SO _x , HCl and HF emission reduction	SO ₂ 95-200 (mg/Nm ³) HCL 1-5 (mg/Nm ³) HF 1-3 (mg/Nm ³)	SO ₂ 135-250 (mg/Nm ³)
4	Reduction of emission of dust and metals contained in dust to the air	Dust 2-14 (mg/Nm ³)	Dust 4-25 (mg/Nm ³)
5	Reduction of mercury emission (Hg) to air	Hg 1-9 µg/Nm ³)	None

Table 3: Emission standards for existing cogeneration sources and an existing gas boiler with a dual-burner

No.	Natural gas fired cogeneration	Natural gas fired boiler
1	NO _x 190 (mg/Nm ³) with 15% of oxygen (since 2030)	NO _x 150 (mg/Nm ³) with 15% of oxygen
2	None	SO ₂ 35 (mg/Nm ³) with 3% of oxygen
3	None	Dust 5 (mg/Nm ³) with 3% of oxygen

Table 4: BAT standards for existing WR25, cogeneration and gas boiler peak sources

No.	Solid fuels for units >100 MW & <300 MW, existing, peak sources	Natural gas fired cogeneration	Natural gas fired boiler
1	NO _x 450 (mg/Nm ³) with 15% of oxygen (since 2030)	NO _x 190 (mg/Nm ³) with 15% of oxygen	NO _x 150 (mg/Nm ³) with 15% of oxygen
2	SO ₂ 800 (mg/Nm ³) with 6% of oxygen	None	SO ₂ 35 (mg/Nm ³) with 3% of oxygen
3	Dust 25 (mg/Nm ³) with 6% of oxygen	None	Dust 5 (mg/Nm ³) with 3% of oxygen

to the use below 1500 h on an annual basis, do not have to meet the BAT requirements. However, these sources must comply with the ordinance of the Minister of the Environment of 6 April [19]. The following Table 4 contains standards for existing WR25, cogeneration and gas boiler peak sources. The above work regime will involve the need to build four additional dust extraction systems for these sources to achieve dust levels of 25 mg/Nm³. In cooperation with DHC, it was established that expenditure capital related to the installation of a new generative unit would amount to 8 million PLN. Similarly to the first variant, the dust extraction system uses electricity and compressed air. This results in 170 kW per hour of work for one unit per boiler and on average, 34 PLN per hour for the coal boiler.

5.3. Variant 3: Additional gas-fired boiler and CHP engine

The last variant of the system is near identical to variant No. 2. It is based on the reference model, the coal boilers have been operated in a regime of <1500 h per year each, whilst the 15 MW gas boiler (mentioned in the previous paragraph) works in the system. The additional production unit is a CHP engine with a capacity of 1.9 MWt / 2 MWe, identical to the units already operating in the system. A new CHP unit was added to analysis if guaranteed bonuses supporting cogeneration planned by Polish Government would improve the economic situation of DHC. In cooperation with DHC, it was established that the installation of a full harmful substances reduction system would cost about 3.5 million PLN and a new CHP unit investment would be 6.8 million PLN.

6. Results and discussion

In the following, the results of the system simulations are presented regarding financial outcomes. The results for three different variants are shown in Table 5.

It should be noted that both Variants 1 and 2 have identical revenues of 32 364 476 PLN, while Variant's

3 revenue is 3 088 371 PLN higher, which is caused by profits from the export of surplus electricity and additional profits from CHP funding. Variants of coal-fired boilers working in a regime of the reduced number of hours, the need for production from natural gas-based units increases, which entails higher consumption of this fuel. Together with the decreasing number of working hours, coal boilers costs related to the emission of harmful substances into the atmosphere generated from coal boilers fall by more than 58% in option 1 and over 60% in option 2. At the same time, increased pressure on the operation of gas and CHP boilers results in an increase in emission costs by over 75%. On the other hand general outcome of emissions variances results in almost 45% decrease in emissions expenditures. The costs of purchasing a larger amount of natural gas are so high that they generate negative revenue per year. The co-financing of cogeneration, which at the level of 40 PLN is not able to improve the economic situation of the enterprise, despite obtaining 619 520 PLN subsidy. Assuming the same amount of electricity generation from a new engine, the value of CHP funding would have to exceed 60 PLN/MWh to improve outcome.

Table 5 does not include investment expenditures of the proposed solutions, but only costs related to the operation of the district heating company. In order to realize such large investments, DHC would have to take appropriate steps to obtain loans and additional co-financing. However, already at this level is visible that if the company does not bring profits, it would not be able to repay any loan installments. The key aspect is the price of natural gas, which at the level of 1.2 PLN/m³ generates no profits. However, a decrease by 0.1 PLN/m³ would cause a drop in the cost of natural gas purchase by 2 397 361 PLN in Variant 2 and it would lead into a positive annual profit of the company. This would be possible, for example, by negotiating the price with the supplier, caused by a significant increase in the demand for fuel

Table 5: Simulation results summary

Revenues	Unit	Price PLN/unit	Variant 1		Variant 2		Variant 3	
			Amount	Value [M PLN]	Amount	Value [M PLN]	Amount	Value [M PLN]
Sale of heat	MWh	110	198782.10	21.87	198782.10	21.87	198782.10	21.87
Sale of el.en.	MWh	DAM	22295.33	3.76	22295.33	3.76	22295.33	3.76
Surplus electricity	MWh	DAM	30204.10	4.64	30204.10	4.64	45692.10	7.11
CHP promotion								
CHP1	MWh	40	17515.60	0.70	17515.60	0.70	17515.60	0.70
CHP2	MWh	40	17508.70	0.70	17508.70	0.70	17508.70	0.70
CHP3	MWh	40	17457.10	0.70	17457.10	0.70	17457.10	0.70
CHP4	MWh	40					15488.00	0.62
CHP promotion Total				2.10		2.10		2.72
Total Revenues					34.46		34.46	37.55
Expenditures								
Purchase of gas	1000 m ³	1.20	13554.87	16.27	23973.6	28.772	27172.26	32.61
GB maintenance cost				0.012		0.020		0.012
Purchase of coal	t	330	28142.70	9.29	12456.20	4.11	10825.80	3.57
CHPs maintenance cost				0.41		0.41		0.41
CB maintenance cost				0.89		0.89		0.89
Grid Tariff	MWh	200	5.80	~ 0	5.80	~ 0	5.80	~ 0
Dust extraction system	h	34	9349.00	0.32	5487,00	0.19	5.76	~ 0
Flue gas desulfurization installation				0.48				
Emission CO_coal	t	110	10.62	0.001	4.70	517	4.08	~ 0
Emission SO2_coal	t	530	147.80	0.078	65.42	0.035	56.86	0.03
Emission NOx_coal	t	530	55.05	0.029	24.37	0.013	21.18	0.011
Emission Dust_coal	t	350	33.55	0.0117	14.85	0.0052	12.90	0.0045
Emission Soot_coal	t	147	0.63	~ 0	0.28	~ 0	0.24	~ 0
Emissions from coal Total				0.124		0.056		0.048
Emission CO_gas	t	110	3.25	~ 0	5.75	~ 0	6.52	~ 0
Emission NOx_gas	t	530	23.72	0.012	41.95	0.022	47.55	0.025
Emissions from gas Total				0.013		0.02		0.03
Emissions Total				0.14		0.07		0.07
Total Operating Expenditures				27.8		34.47		37.57
Operation income				6.66		-0.0028		-0.016

7. Conclusions

Regulations regarding the introduction of BATs after 2022 significantly complicate the technical and economic situation of heat plants / CHP plants located in Poland. As can be seen from the results presented in the previous parts of this article, the two most-considered

scenarios of adaptation to BAT implemented in DHCs are not optimal in terms of both economic and energy efficiency, not to mention the resignation from using fossil fuels. This state of affairs is caused by the lack of specific decisions at the European and national level regarding financial support allowing for energy

transformation in countries where coal is the main energy carrier. In this article, the authors analyzed the most frequently considered energy transformation scenarios of a DHC type company.

In the beginning, it should be noted that all calculations made in this article are qualitative and not quantitative.

In the analyzed cases, the most popular option is the one installing appropriate filtration to existing coal installations, which meet the BAT guidelines,. This is currently the safest option when it comes to operating costs of the installation, which currently provides the largest profits but also brings the perspective of no vision for a change in the heating plants energy systems currently operating in Poland. It is highly probable that in a few years, the now installed filtering installations will not meet the next climate requirements. Summarizing variant no. 1: it is currently the most-considered option in Poland.

Another analyzed approach to solving the BAT problem, is the limitation of the operating times of coal boilers to up to 1500h/per annum, and producing the shortage of heat using natural gas. This is an option that is now gaining more and more sympathizers. Unfortunately, this is an option that, based on the assumptions made by the authors, does not allow to generate profit, however, it allows to feel safe in the context of future possible changes regarding the regulation tightening on climate change. The authors note that the reduction of the price of gas (with the assumptions for the energyPRO model) by 0.1 PLN (0.1 PLN=0.024 EUR) results in savings of 3.5 million PLN.

To sum up, for Poland and the countries of Eastern Europe, there is still a lot of work to be done on the subject of energy transformation. This article was designed to show the initial paths chosen by companies that can directly relate to this topic. The authors hope, that it will allow readers to see a larger perspective on the current problems of the energy sector in Eastern European countries with Poland being an example.

Acknowledgements

This article was invited and accepted for publication in the EERA Joint Programme on Smart Cities' Special issue on *Tools, technologies and systems integration for the Smart and Sustainable Cities to come*[20].

The work was supported by the SuPREME project that has received funding from the European Union's Horizon 2020 research and innovation programme under Grant Agreement Number 692197

References

- [1] Wierzbowski M, Filipiak I, Lyzwa W. Polish energy policy 2050 – An instrument to develop a diversified and sustainable electricity generation mix in coal-based energy system. *Renew Sustain Energy Rev* 2017. <https://doi.org/10.1016/j.rser.2017.02.046>
- [2] Lecomte T, Ferrería De La Fuente J, Neuwah F, Canova M, Pinasseau A, Jankov I, et al. Best Available Techniques (BAT) Reference Document for Large Combustion Plants. *Eur Comm* 2017. https://eippcb.jrc.ec.europa.eu/reference/BREF/LCP/JRC107769_LCP_bref2017.pdf
- [3] Werner S. International review of district heating and cooling. *Energy* 2017;137:617–31. <https://doi.org/10.1016/j.energy.2017.04.045>
- [4] Lund H, Østergaard PA, Chang M, Werner S, Svendsen S, Sorknæs P, et al. The status of 4th generation district heating: Research and results. *Energy* 2018;164:147–59. <https://doi.org/10.1016/j.energy.2018.08.206>
- [5] Kontu K, Rinne S, Junnila S. Introducing modern heat pumps to existing district heating systems – Global lessons from viable decarbonizing of district heating in Finland. *Energy* 2019;166:862–70. <https://doi.org/10.1016/j.energy.2018.10.077>
- [6] Popovski E, Aydemir A, Fleiter T, Bellstädt D, Büchele R, Steinbach J. The role and costs of large-scale heat pumps in decarbonising existing district heating networks – A case study for the city of Herten in Germany. *Energy* 2019;180:918–33. <https://doi.org/10.1016/j.energy.2019.05.122>
- [7] Kazagic A, Merzic A, Redzic E, Tresnjo D. Optimization of modular district heating solution based on CHP and RES - Demonstration case of the Municipality of Visoko. *Energy* 2019;181:56–65. <https://doi.org/10.1016/j.energy.2019.05.132>
- [8] Fragaki A, Andersen AN, Toke D. Exploration of economical sizing of gas engine and thermal store for combined heat and power plants in the UK. *Energy* 2008;33:1659–70. <https://doi.org/10.1016/j.energy.2008.05.011>
- [9] Østergaard PA, Jantzen J, Marcinkowski HM, Kristensen M. Business and socioeconomic assessment of introducing heat pumps with heat storage in small-scale district heating systems. *Renew Energy* 2019;139:904–14. <https://doi.org/10.1016/j.renene.2019.02.140>
- [10] Fragaki A, Andersen AN. Conditions for aggregation of CHP plants in the UK electricity market and exploration of plant size. *Appl Energy* 2011;88:3930–40. <https://doi.org/10.1016/j.apenergy.2011.04.004>
- [11] Ben Amer S, Bramstoft R, Balyk O, Nielsen PS. Modelling the future low-carbon energy systems - a case study of Greater Copenhagen, Denmark. *Int J Sustain Energy Plan Manag* 2019;24. doi:10.5278/ijsepm.3356

- [12] Ancona MA, Bianchi M, Branchini L, De Pascale A, Melino F, Peretto A. Low temperature district heating networks for complete energy needs fulfillment. *Int J Sustain Energy Plan Manag* 2019;24. doi:10.5278/ijsepm.3340
- [13] energyPRO references: Licence Holders n.d. <https://www.emd.dk/references/energyPRO/>
- [14] Buńczyk A, Bogusławski P. *Energetyka Ciepna w liczbach - 2017*. Warsaw: Urząd Regulacji Energetyki; 2018. <https://www.ure.gov.pl/pl/cieplo/energetyka-cieplna-w-l/7662,2017.html>
- [15] Cat® G3516H Gas Generator Sets datasheet., n.d. <https://s7d2.scene7.com/is/content/Caterpillar/CM20170821-74557-46197>
- [16] Hoval THW-I HTE Industrial Boiler. *Plant Eng Handb* 2013:387–413. doi:10.1016/b978-075067328-0/50025-2. <https://www.hoval.co.uk/products/thw-i-hte/>
- [17] Hoogsteen G. A cyber-physical systems perspective on decentralized energy management. 2017. <https://doi.org/10.3990/1.9789036544320>
- [18] Dochev I, Seller H, Peters I. Spatial aggregation and visualisation of urban heat demand using graph theory. *Int J Sustain Energy Plan Manag* 2019;24. doi:10.5278/ijsepm.3346
- [19] DZIENNIK USTAW. Rozporządzenie MINISTRA ŚRODOWISKA z dnia 1 marca 2018 r 2018;Poz. 680. <http://prawo.sejm.gov.pl/isap.nsf/download.xsp/WDU20180000680/O/D20180680.pdf>
- [20] Østergaard PA, Maestosi PC. Tools, technologies and systems integration for the Smart and Sustainable Cities to come. *Int J Sustain Energy Plan Manag* 2019;24. <http://doi.org/10.5278/ijsepm.3450>



RESEARCH and EXPERIMENTATION

Interconnection of the electricity and heating sectors to support the energy transition in cities

Verena Heinisch*, Lisa Göransson, Mikael Odenberger and Filip Johnsson

Department of Space, Earth and Environment, Chalmers University of Technology, Gothenburg, Sweden

ABSTRACT

The electricity, heating, and transport sectors in urban areas all have to contribute to meeting stringent climate targets. Cities will face a transition from fossil fuels to renewable sources, with electricity acting as a cross-sectorial energy carrier. Consequently, the electricity demand of cities is expected to rise, in a situation that will be exacerbated by ongoing urbanisation and city growth. As alternative to an expansion of the connection capacity to the national grid, local measures can be considered within city planning in order to utilize decentralised electricity generation, synergies between the heating and electricity sectors, and flexibility through energy storage technologies.

This work proposes an optimisation model that interconnects the electricity, heat, and transport sectors in cities. We analyse the investments in and operation of an urban energy system, using the City of Gothenburg as an example. We find that the availability of electricity from local solar PV together with thermal storage technologies increase the value of using power-to-heat technologies, such as heat pumps. High biomass prices together with strict climate targets enhance the importance of electricity in the district heating sector. A detailed understanding of the integration of local low-carbon energy technologies can give urban planners and other city stakeholders the opportunity to take an active role in the city's energy transition.

Keywords:

Urban energy planning;
Flexibility;
District heating;
Smart cities;
Photovoltaic;

URL: <http://doi.org/10.5278/ijsepm.3328>

1. Introduction

The development and planning of cities in the 21st century face a number of challenges. Concomitant with managing continuous growth and urbanisation [1], cities must implement policies to meet climate targets and mitigate carbon emissions [2]. Energy planning in cities has to include and integrate efficiently the different sectors for electricity, mobility, heating and cooling, into what is often called “smart cities” [3,4]. Increased electrification is seen as one corner-stone of this development. New electricity loads, together with an increased population density, are likely to increase the annual and peak electricity demands of cities. As a consequence, several cities have identified an urgent need to increase

the connection capacity from the national electricity grid. Investments in new capacity are often associated with long lead-times. An alternative, which is the focus of the present work, is to increase reliance on local electricity and heat generation, in combination with the utilisation of flexibility by storage technologies.

Sectorial couplings and electrification have, on larger geographical scales, been identified as important components of a fossil-free energy system [5,6]. How such couplings play out on a limited urban scale remains to be analysed in detail. The different parts of city energy systems are represented in the literature by, for example, the integration of a large share of renewables into the urban energy system [7–10], the integration of electric vehicle charging [11–13], the operation of urban district heating

*Corresponding author - e-mail: verena.heinisch@chalmers.se

Acknowledgement of value

The North European Energy Perspectives (NEPP), a multidisciplinary project focusing on the development of local and national North European energy systems is funded by partners including energy companies, industry and the Swedish Energy Agency.

Local access of power has become a major challenge in parts of Sweden. Urbanisation, new construction and the transition from fossil fuel to electricity leads to growing electricity demand in cities. Part of the solution will be increased interaction between sectors and local production units, but many questions for city planning remain.

The model developed in this research provides an important tool to analyse the interconnection between the electricity, heat and transport sectors. The model and analysis of design and operation of a city's energy system is crucial for local strategic planning and the possibility to reach climate targets. The stakeholders in NEPP will benefit from the result of the research.

Kjerstin Ludvig, Project management NEPP

systems [14–17], and sector-overlapping analyses [18–21]. Previous studies have provided valuable insights into low-carbon scenarios in different parts of the city energy system. The present work adds to this body of knowledge by including options for investments and dispatch of technology in relation to both the electricity and heating systems, as part of the techno-economic optimisation modelling. We model future, zero CO₂-emission energy systems in growing cities, with the focus on the interconnections between the electricity and heating sectors, while considering a fixed limit on hourly electricity import from the national grid.

This paper presents and applies a linear urban energy system optimisation model and analyses:

- The potential role of local energy balancing, i.e. local electricity and heat generation, together with electricity and thermal storage technologies; and
- Investments in and the composition of urban electricity and district heating systems, directed towards meeting stringent CO₂ emission targets.

The model is applied using the city of Gothenburg as a case study. Similar to other cities, for example Copenhagen [22], the city of Gothenburg has formulated strategies to reduce its climate impact, by aiming to e.g. phase out fossil fuels in the district heating system, produce 500 GWh of renewable electricity and reduce CO₂ emissions from road transport by 80% as compared to 2010, all by 2030 [23].

The paper is organised as follows. Section 2 describes the flexibility potential of sectorial coupling in an urban energy system and the method developed. Section 3 gives the results from the modelling of an example city. Section 4 presents a discussion of the assumptions made

in the modelling. Section 5 presents the conclusions drawn and reflections as to further developments to the proposed model.

2. Method

This work represents a part of the development of a linear energy system optimization model for cities, which includes investments as well as the dispatch of energy technologies with hourly time resolution, herein applied to the city of Gothenburg, Sweden. Figure 1 presents the different modules of the city optimization model. The objective of the model is to minimize the total operational and investment costs in the electricity and heating sectors, while complying with a constraint on CO₂ emissions. A full description of the model used in this study is provided online in the Appendix A.

In the model, the hourly electricity load profile can be met by a combination of electricity that is imported from the national electricity grid to the city, electricity that is generated within the city borders and electricity that is discharged from an electricity storage. The amount of electricity that can be imported is limited by the import capacity. To focus the analysis on the effect of local generation and storage technologies on system design and operation, no export from the city energy system to the national grid is considered in the current version of the model. The hourly district heating demand cannot be met by heat delivered from outside of the city but has to rely on local heat production within the urban district heating system or the heat discharged from thermal storage units.

The electricity and district heating demand profiles are used as inputs to the model, together with a

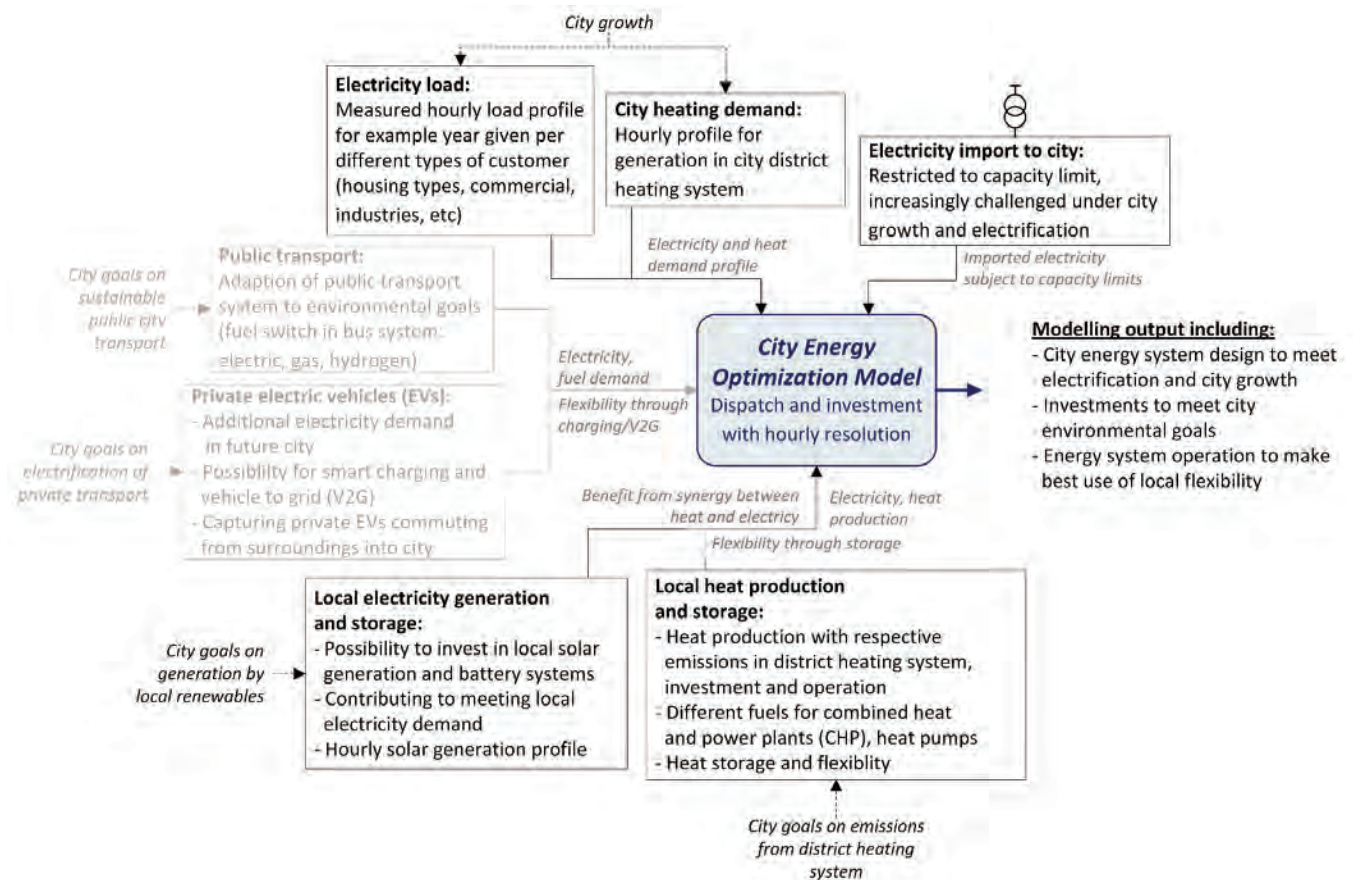

Figure 1: Schematic of the City Energy Optimisation Model with its inputs (squared boxes) and outputs, where inputs are specified for the electricity, heat, and transport sectors. The shaded boxes are modules that are under development and will be addressed in future studies

description of the existing electricity and heat generation units presently available in the City of Gothenburg. Thus, new investments in heat generation and storage technologies are made by the model for replacing fossil-fuelled technologies and to cover the increased demand for heat. New electricity generation and storage capacity are invested in when competitive compared to importing electricity from the national grid or if the import capacity cannot meet demand in the city. The model minimises the total cost to supply electricity and heating demand for 1 year, i.e., the investment and operational costs for electricity, heating, and storage technologies with a constraint on CO₂ emissions.

The modelling includes the following technology options:

- **Electricity generation:** Solar PV technologies, peak power gas turbines fired by natural gas or biogas.

- **Electricity storage:** Li-Ion batteries, flow batteries.
- **Combined heat and power (CHP):** CHP fired by biomass (wood chips), waste, natural gas or biogas.
- **Heat production:** Heat-only boilers (HOB) fired by biomass, natural gas, biogas, waste or oil, heat pumps, electric boilers, industrial excess heat.
- **Thermal storage:** Tank storage, pit storage, borehole storage.

Details of the current heat and power system and the costs and technical assumptions associated with the investments options are given online in Appendix B. The electric vehicle and public transport modules of the optimisation model, shown in grey in Figure 1, are not part of the results presented in this work, which focuses on the interconnections between the electricity and heating sectors, including the use of heat and electricity storage

units. The synergies between electric vehicle charging and discharging and the city electricity and heating sectors will be investigated in a future study.

2.1. Flexibility and synergies in the electricity and district heating sector

Figure 2a shows the hourly profiles of electricity and heat demand for the City of Gothenburg, used as inputs to the model. It is clear that there are pronounced seasonal variations, as well as variations on the weekly, diurnal and hourly levels. The model applies the above mentioned technology options to supply the district heat demand and electricity for the city demand. Heat generation technologies include electricity-dependent options, such as heat pumps. In addition, the model includes storage options for both heat (within the district heating system) and electricity (battery technologies). Thus, the model can evaluate the potential for flexibility and the linkages between electricity and district heating. The hourly electricity price, as utilized for electricity imported to the city energy system in the modelling is presented in Figure 2b, with details on input data given in the Appendix online.

2.2. Cases and input assumptions

Table 1 provides a summary of the input data that describe the energy system for the City of Gothenburg

and the common assumptions made to represent its future development, i.e., assumptions that remain the same in all the modelled cases. Thus, in the modelled cases Gothenburg is assumed to have increased electricity and heat demand by a factor of 1.5. Yet, in the model the connection capacity from the national grid to the city is limited to present day levels. This means that in modelled future cases the connection capacity limit corresponds to 55% of the maximum winter electricity load; and that there is sufficient connection capacity to cover all load by imported electricity during about 4 000 hours per year. In short, we model increasing demand in a city that is assumed to grow in size and population, however, without any possibility of new investments in connection capacity to the national grid. With these assumptions, we investigate the roles of local generation and flexibility in the city energy system.

For the case study of the city of Gothenburg we investigate two base modelling cases and three additional modelling cases in a sensitivity analysis. The cases differ in terms of the cost assumptions for biomass (and biogas), PV, and batteries, as presented in Table 2. The *Low Cost Bio* case is intended to reflect the cost assumptions for a near-term future, while the *Low Cost PV* case should represent a longer-term future, with greater competition for biomass. The trajectories of the PV and battery investment costs and biomass prices are uncertain. To specify

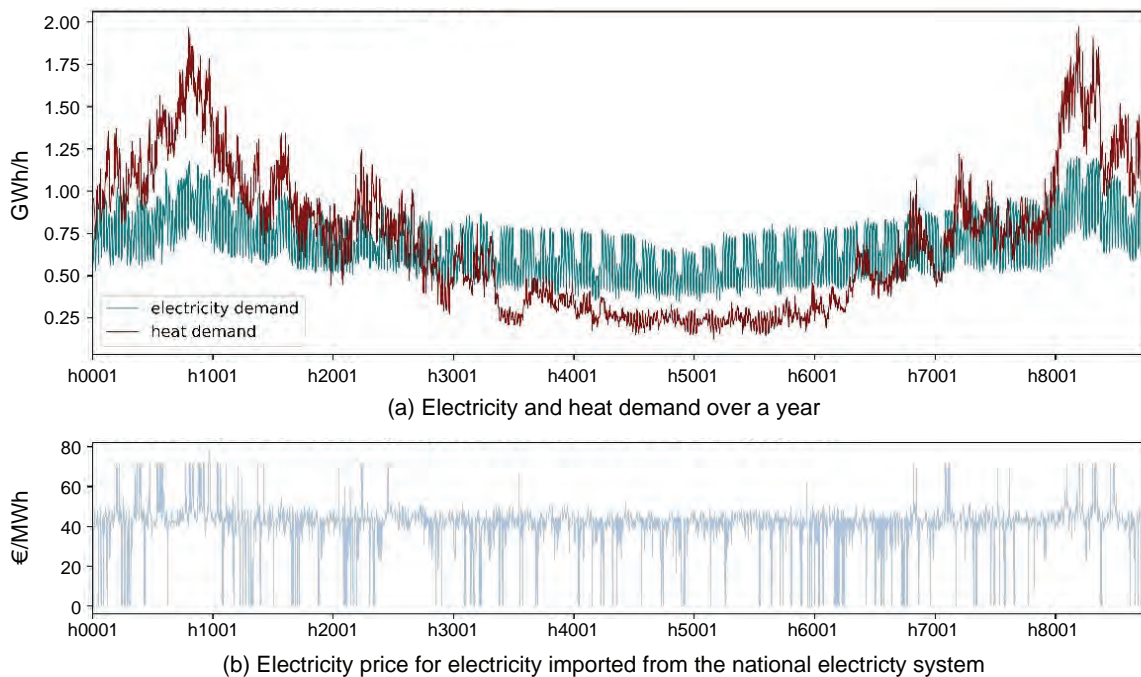

Figure 2: (a) Hourly electricity and district heating demand profile obtained for the City of Gothenburg, (b) Electricity price for electricity imported from the national electricity system, both as used in the modelling

Table 1: Input data used to describe the energy system of Gothenburg and assumptions made in modelling its future development (common to all the modelled cases)

Input data on the energy system	
Electricity and heat demand profile (hourly)	Actual profile for Year 2012
Connection capacity to the national system	As currently (2019) in place
Heat and electricity generation capacity in place (cf. Appendix B)	As of Year 2019, this considers the fuels used to run these processes and whether they are in line with the emissions constraint
Common assumptions for all cases:	
Demand growth	Both, the electricity and heat demand are assumed to increase by a factor of 1.5
Emissions targets	Zero emissions (not considering the emissions related to the electricity imported from the national grid)
Electricity price for imported electricity	Hourly price curve, as taken from the results of a Northern European dispatch model (for a future with an increased share of electricity generation from variable renewables) [24]

Table 2: Overview of the modelled cases and case-specific assumptions related to PV and battery investment costs and biomass fuel costs

	PV costs [€/kW _p]	Biomass fuel costs [€/MWh] ^a	Battery costs [€/kWh]
Base Cases:			
Low Cost Bio	600	20	150
Low Cost PV	300	40	150
Sensitivity analysis:			
Higher Cost Battery	600	20	300
Higher Cost PV	600	40	150
Low Cost PV, Low Cost Battery	300	40	70

^a Biogas prices are calculated from biomass prices

the influences of technology and fuel cost assumptions in future years, we chose to assume the same level of city growth and a zero CO₂ emission target for all the cases. For each case, the optimisation modelling is run separately, and the results are compared in the analysis. A discount rate of 5% has been assumed for all model runs.

3. Results

3.1. Development of the city district heating and electricity sector

Owing to the constraints imposed on emissions from fossil fuel-fired technologies, the model phases-out approximately 300 MW of CHP capacity and 570 MW of HOB capacity, currently run on fossil fuels, mainly natural gas. In neither the *Low Cost Bio* case nor the *Low Cost PV* case, phased-out capacity is replaced with the same amount of CHP and HOB capacity compared to present levels. The future technology mix consists of less CHP and HOB capacities that are run on biomass

fuels, and investments in solar PV, biogas turbines, electric HOB capacities and electricity and thermal storage units. Lower total capacity is required, because storage systems enable a more flexible utilization of the installed capacities and smoothening of the loads.

Figure 3 shows the dispatch of the generation and storage portfolio over a whole year for the *Low Cost Bio* case. It is evident that peak technologies, i.e. biogas-fired gas turbines for electricity and HOBs for heat, are used during the winter months. CHP fired by biomass is, however, operated also in the summer months, albeit at a reduced output. This is despite lower electricity and heat demands and higher level of electricity generation from solar PV during the summer months. The operation of the biomass CHP generation over different periods in the summer correlates well with the amount of thermal energy stored in the pit storage. In other words, a higher level of generation from CHP during the summer often increases the storage level in the pit storage. The waste heat production from industry is relatively constant over

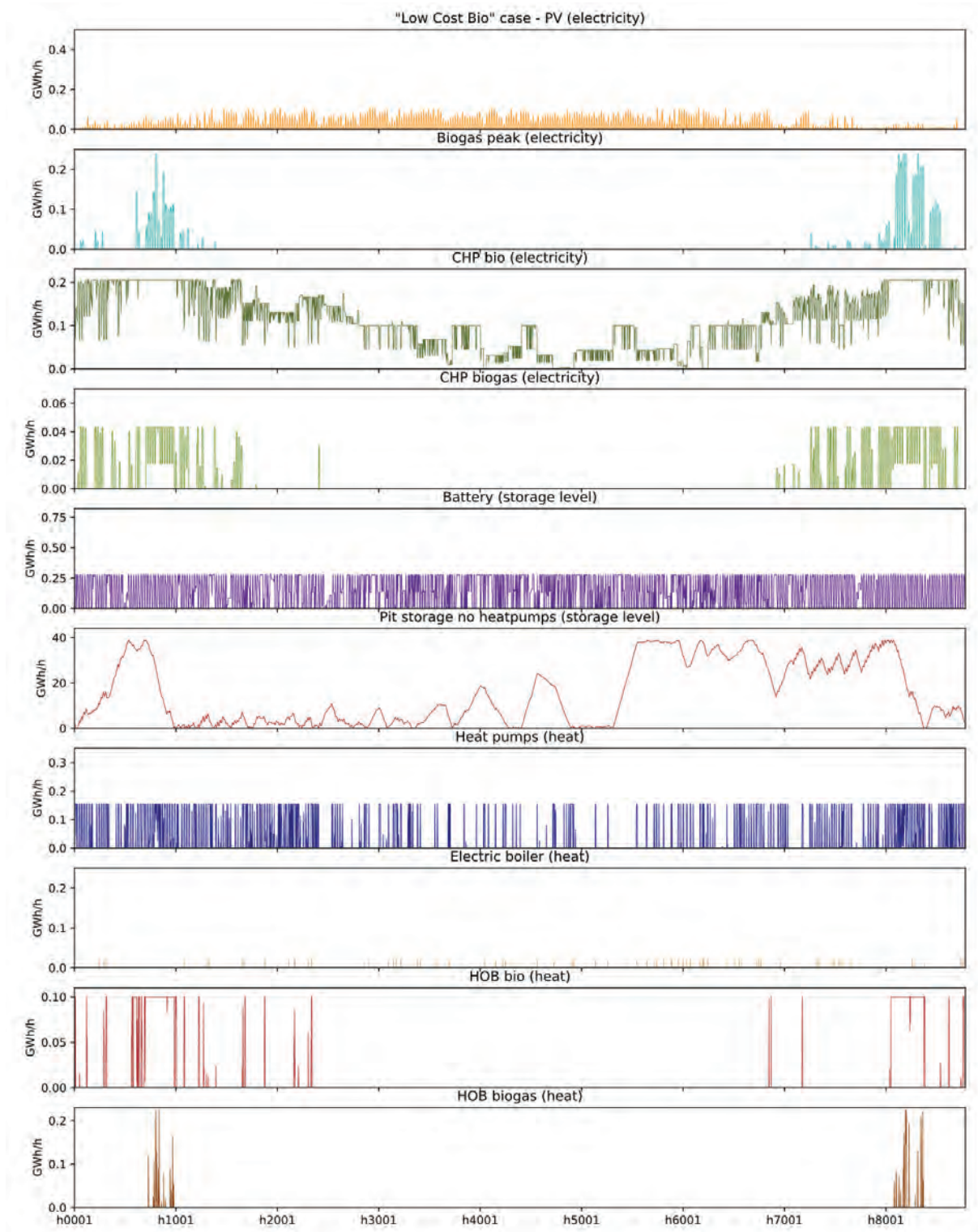

Figure 3: Dispatches of the different technologies for an entire year in the Low Cost Bio case, as obtained from the modelling. For electricity generation technologies, the electricity output is plotted, whereas for heat production technologies, the heat output is plotted. The power-to-heat ratios of 0.3 for biomass and 1.6 for biogas CHP plants explain the corresponding heat production levels from the CHP units.

Observe that the scale for PV generation differs from the one in Figure 4, for better readability

the summer months. We have also found that CHP generation is reduced during hours of low electricity prices when more electricity is imported into the city and heat pumps and electric boilers are used to provide heat. The possibility to utilise thermal pit storage to supply heat during periods of highest heat demand can be assumed to dampen HOB investment and generation in this modelled case.

Figure 4 shows the dispatch of the different technologies for the *Low Cost PV* case. The biggest differences in relation to the *Low Cost Bio* case are the much larger investments in solar PV (due to the lower PV investment costs), as well as the investment in additional thermal storage capacity. The excess electricity from PV is stored either in batteries or as heat, mostly in long term pit storage. Thus, thermal pit storage with heat pumps is utilised as seasonal storage, as shown in Figure 4, whereby the storage level is at its lowest in the middle of April and peaks during September. It is also evident that biomass CHP is utilised to a lesser extent, especially during the summer months when CHP is not in operation. The large PV capacity, together with electricity imports and storage options are sufficient to supply the summer electricity load. The utilisation of heat pumps in the *Low Cost PV* case is more related to the PV generation profile than to the electricity price. It should be kept in mind that in the cases modelled, export of excess electricity from local generation in the city is not possible. Thus, heat pumps, especially during summer, are run to make use of PV-generated electricity, supply the heat load, and charge the thermal storage. Moreover, as a consequence of the high level of generation from PV, there are many more hours without electricity imports (especially in the day-time) in the *Low Cost PV* case, as compared to the *Low Cost Bio* case.

3.2. Synergies between the urban electricity and heat sectors

The *Low Cost PV* case, which combines lower PV costs with higher prices for biomass, shows a clear relationship between the electricity and heating sectors. Especially during summer, electricity is utilised for heat production, which is then combined with thermal seasonal storage. Pit storage systems with heat pumps have low constant losses and are therefore suitable for long-term storage. Tank storage in the *Low Cost PV* case takes on a role somewhat intermediate, in terms of storage duration, compared to the roles of battery storage (which stores electricity for usually not longer than a

day) and pit storage. The time between charging and discharging of the tank storage units here varies from several hours up to several days.

3.3. Sensitivity analysis: Impact of PV and battery prices

The *Higher Cost PV* case, obviously, leads to a lower PV capacity compared to the *Low Cost PV* case, although it is still clearly higher than in the *Low Cost Bio* case. The 721 MW of PV capacity (almost 80% of the summer peak electricity load) that results from investment in the Higher Cost PV case is sufficient to avoid having to use wood chips CHP during the summer (biomass is an expensive fuel in both the *Low Cost PV* and the *Higher Costs PV* cases). Applying an assumption of a higher battery price of 300 €/kWh (as opposed to the 150 €/kWh price used in the base cases) exerts a weak impact on the results. Yet, the availability of cheaper batteries (at 70 €/kWh) in the *Low Cost PV*, *Low Cost Battery* case increases investments in PV and battery capacities, while reducing investment in biogas-fired peak units and heat pumps.

4. Discussion

In this work, a simplified growth factor of 1.5 for both the electricity and heat sectors in the city energy system has been applied to all the cases modelled. Yet, the development of future electricity and heating loads is highly uncertain. Energy efficiency measures on the electricity or heating side, the implementation of demand-side management and the utilisation of the building shell for thermal storage could influence the shapes of the demand profiles for electricity and heating. Considering any of the above measures in the analysis could flatten some of the demand peaks and thereby reduce the utilization of batteries and tank storage units, as compared to the results presented in this work. The magnitude of demand growth in the city's electricity and heating sectors over the upcoming decades depends largely on how the city continues to grow. New construction projects in cities often include low-energy buildings. At the same time, new, large-scale consumers (such as those arising from the electrification of industrial or manufacturing sites) could emerge.

The availability of sustainably harvested biomass in future scenarios and the assumed costs for this fuel are highly uncertain. Larger competition for biomass can be expected in future energy systems, raising the question

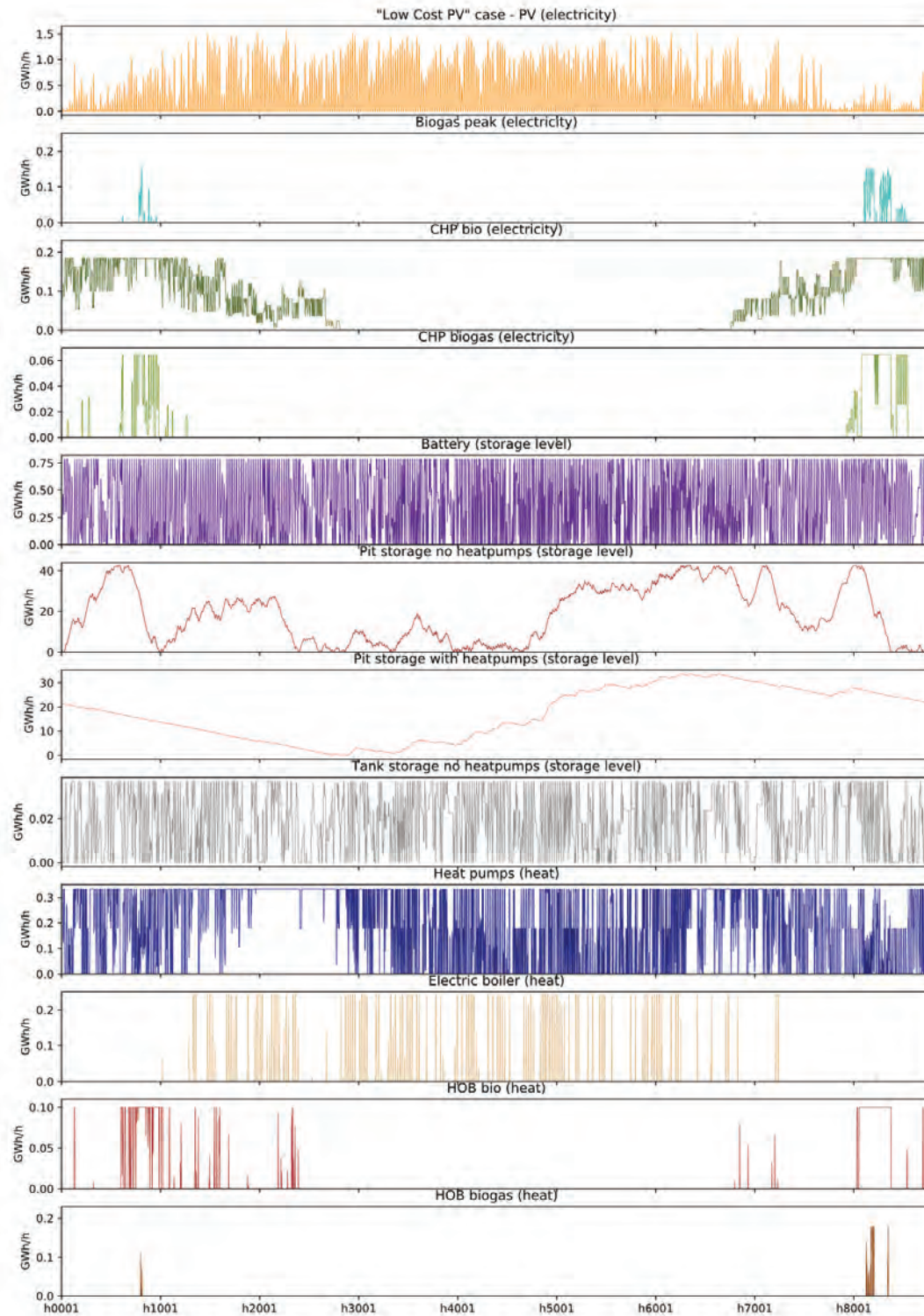

Figure 4: Dispatches of the different technologies for an entire year in the Low Cost PV case, as obtained from the modelling. For electricity generation technologies, the electricity output is plotted, whereas for heat production technologies, the heat output is plotted. The power-to-heat ratios of 0.3 for biomass and 1.6 for biogas CHP plants explain the corresponding heat production levels from the CHP units

whether the urban energy system is the best option to utilize this scarce resource in, or whether there are other sectors or other regions in the world with less alternatives to biomass that should be prioritized.

The sectoral integration in the city energy system involves the collaboration of a number of actors and stakeholders that traditionally did not develop common strategies. One aspect that can facilitate installation and operation of local energy technologies are local prices for electricity and heat. In a city where electricity import capacity is at its limits (as with the assumptions in the case study modelled) there should be an increased value of local generation of electricity to the urban energy system. If this value is also seen by local actors, through e.g. local prices or local markets for energy, an incentive is created for local energy generation and storage. Another option to foster a common organization of the city energy transition is the formulation of energy and climate goals and regulations imposed on urban actors to meet these. With an increased interest of private actors, like household customers, in owning small-scale generation and storage units parts of the investment in local technologies could be driven by small-scale actors. The EU's "The clean energy for all Europeans package" [25] enables active energy citizens and communities to be part of energy markets and thereby support the energy transition.

5. Conclusions and further work

Local integration of the electricity and heating sectors in the city energy system presents, to some extent, a viable alternative to expansion of the connection capacity to the national grid for growing cities. Thus, local balancing can make it possible for local stakeholders to address the issues of increasing energy/capacity demand and carbon-neutral energy supply and at the same time avoid costs and long lead times associated with new power lines and transformer stations. This work, which is based on a model developed to analyse the operation of integrated electricity and heating sectors in a smart city, evaluates two main cases with price assumptions on solar PV and biomass fuels using the City of Gothenburg as an example: a) A near-term future case, including low biomass fuel prices and higher PV investment costs, and b) a more-distant future case with higher biomass price and lower PV investment cost.

The results show that low-cost electricity within the city (here in the form of PV, assuming a further decrease in investment costs) is not only valuable in terms of the

city's electricity system, but also with respect to providing heat through power-to-heat technologies. This is especially the case when there is a high cost for biomass. Thermal and electricity storage systems that shift energy over hours, days or even seasons become an important part of the city's energy system mix in all the cases investigated, especially when electricity from solar PV is available in abundance.

Future work will present an in-depth analysis of the impacts of electric vehicle charging and vehicle to grid discharging on the investments in and operation of electricity and heating technologies. Scenarios that involve other energy carriers, such as hydrogen could also be investigated. Public transport, in the form of busses run on electricity, hydrogen or biogas, can enrich the description of the transport sector in the urban energy system model.

Acknowledgements:

This article was invited and accepted for publication in the EERA Joint Programme on *Smart Cities' Special issue on Tools, technologies and systems integration for the Smart and Sustainable Cities to come* [26].

Appendix/Supplementary material:

Details on the mathematical model formulation and important input data is found online under <http://dx.doi.org/10.5278/ijsepm.3328>

References

- [1] World Urbanization Prospects - Population Division - United Nations 2019. <https://population.un.org/wup/Country-Profiles/> (accessed March 5, 2019).
- [2] IPCC. Summary for Policymakers — Global Warming of 1.5 °C n.d. <https://www.ipcc.ch/sr15/chapter/summary-for-policy-makers/> (accessed June 15, 2019).
- [3] Masera M, Bompard EF, Profumo F, Hadjsaid N. Smart (Electricity) Grids for Smart Cities: Assessing Roles and Societal Impacts. Proceedings of the IEEE 2018;106:613–25. <http://dx.doi.org/10.1109/JPROC.2018.2812212>.
- [4] Calvillo CF, Sánchez-Miralles A, Villar J. Energy management and planning in smart cities. Renewable and Sustainable Energy Reviews 2016;55:273–87. <http://dx.doi.org/10.1016/j.rser.2015.10.133>.
- [5] Mathiesen BV, Lund H, Connolly D, Wenzel H, Østergaard PA, Möller B, et al. Smart Energy Systems for coherent 100%

- renewable energy and transport solutions. *Applied Energy* 2015;145:139–54. <http://dx.doi.org/10.1016/j.apenergy.2015.01.075>.
- [6] Lund H, Østergaard PA, Connolly D, Mathiesen BV. Smart energy and smart energy systems. *Energy* 2017;137:556–65. <http://dx.doi.org/10.1016/j.energy.2017.05.123>.
- [7] Narayanan A, Mets K, Strobbe M, Develder C. Feasibility of 100% renewable energy-based electricity production for cities with storage and flexibility. *Renewable Energy* 2019;134:698–709. <http://dx.doi.org/10.1016/j.renene.2018.11.049>.
- [8] Bagheri M, Delbari SH, Pakzadmanesh M, Kennedy CA. City-integrated renewable energy design for low-carbon and climate-resilient communities. *Applied Energy* 2019;239:1212–25. <http://dx.doi.org/10.1016/j.apenergy.2019.02.031>.
- [9] Lund PD, Mikkola J, Ypyä J. Smart energy system design for large clean power schemes in urban areas. *Journal of Cleaner Production* 2015;103:437–45. <http://dx.doi.org/10.1016/j.jclepro.2014.06.005>
- [10] Möller C, Faulstich M, Rosenberger S. Urban-rural relations in renewable electric energy supply – the case of a German energy region. *International Journal of Sustainable Energy Planning and Management* 2019;21. <http://dx.doi.org/10.5278/ijsepm.2019.21.7>.
- [11] Calvillo CF, Sánchez-Miralles A, Villar J, Martín F. Impact of EV penetration in the interconnected urban environment of a smart city. *Energy* 2017;141:2218–33. <http://dx.doi.org/10.1016/j.energy.2017.12.006>
- [12] Shepero M, Munkhammar J, Widén J, Bishop JDK, Boström T. Modeling of photovoltaic power generation and electric vehicles charging on city-scale: A review. *Renewable and Sustainable Energy Reviews* 2018;89:61–71. <http://dx.doi.org/10.1016/j.rser.2018.02.034>.
- [13] Xylia M, Leduc S, Patrizio P, Kraxner F, Silveira S. Locating charging infrastructure for electric buses in Stockholm. *Transportation Research Part C: Emerging Technologies* 2017;78:183–200. <http://dx.doi.org/10.1016/j.trc.2017.03.005>.
- [14] Wang H, Yin W, Abdollahi E, Lahdelma R, Jiao W. Modelling and optimization of CHP based district heating system with renewable energy production and energy storage. *Applied Energy* 2015;159:401–21. <http://dx.doi.org/10.1016/j.apenergy.2015.09.020>.
- [15] Bachmaier A, Narmsara S, Eggers J-B, Herkel S. Spatial distribution of thermal energy storage systems in urban areas connected to district heating for grid balancing—A techno-economical optimization based on a case study. *Journal of Energy Storage* 2016;8:349–57. <http://dx.doi.org/10.1016/j.est.2016.05.004>
- [16] Ancona MA, Bianchi M, Branchini L, De Pascale A, Melino F, Peretto A. Low temperature district heating networks for complete energy needs fulfillment. *Int J Sustain Energy Plan Manag* 2019;24 2019. <http://dx.doi.org/10.5278/ijsepm.3340>
- [17] Lazzeroni P. Design of a polygeneration system with optimal management for a dhc network. *International Journal of Sustainable Energy Planning and Management* 2019;22. <http://dx.doi.org/10.5278/ijsepm.2450>
- [18] Bačeković I, Østergaard PA. A smart energy system approach vs a non-integrated renewable energy system approach to designing a future energy system in Zagreb. *Energy* 2018;155:824–37. <http://dx.doi.org/10.1016/j.energy.2018.05.075>
- [19] Niemi R, Mikkola J, Lund PD. Urban energy systems with smart multi-carrier energy networks and renewable energy generation. *Renewable Energy* 2012;48:524–36. <http://dx.doi.org/10.1016/j.renene.2012.05.017>
- [20] Salpakari J, Mikkola J, Lund PD. Improved flexibility with large-scale variable renewable power in cities through optimal demand side management and power-to-heat conversion. *Energy Conversion and Management* 2016;126:649–61. <http://dx.doi.org/10.1016/j.enconman.2016.08.041>
- [21] Morvaj B, Evins R, Carmeliet J. Decarbonizing the electricity grid: The impact on urban energy systems, distribution grids and district heating potential. *Applied Energy* 2017;191:125–40. <http://dx.doi.org/10.1016/j.apenergy.2017.01.058>
- [22] Ben Amer S, Bramstoft R, Balyk O, Nielsen PS. Modelling the future low-carbon energy systems - a case study of Greater Copenhagen, Denmark. *Int J Sustain Energy Plan Manag* 2019;24 2019. <http://dx.doi.org/10.5278/ijsepm.3356>
- [23] City of Gothenburg. Climate program för Gothenburg. Gothenburg: n.d.
- [24] Taljegard M, Göransson L, Odenberger M, Johnsson F. Impacts of electric vehicles on the electricity generation portfolio – A Scandinavian-German case study. *Applied Energy* 2019;235:1637–50. <http://dx.doi.org/10.1016/j.apenergy.2018.10.133>.
- [25] Clean energy for all Europeans package. *Energy - European Commission* 2017. <https://ec.europa.eu/energy/en/topics/energy-strategy-and-energy-union/clean-energy-all-europeans> (accessed September 20, 2019).
- [26] Østergaard PA, Maestoso PC. Tools, technologies and systems integration for the Smart and Sustainable Cities to come. *Int J Sustain Energy Plan Manag* 2019;24 2019. <http://dx.doi.org/10.5278/ijsepm.3450>.



International Journal of Sustainable Energy Planning and Management

RESEARCH and EXPERIMENTATION

How can urban manufacturing contribute to a more sustainable energy system in cities?

Tanja Tötzer^{*,1,a}, Romana Stollnberger^a, Roland Krebs^b, Mara Haas^b, Christoph Biegler^c

^aAIT Austrian Institute of Technology GmbH, Giefinggasse 4, 1210 Vienna, Austria

^bsuperwien urbanism ZT OG, Lenaugasse 2/4, 1080 Vienna, Austria

^cFraunhofer Austria Research GmbH, Theresianumgasse 27, 1040 Vienna, Austria

ABSTRACT

The paper explores future opportunities as well as challenges arising from urban manufacturing (UM) regarding the design of sustainable energy systems for cities. Global trends affect the type of production (e.g. Industry 4.0) as well as the industrial structure (e.g. convergence of services and production) of UM in cities. This causes new requirements but also new options for the urban energy system. The study presented in this paper examines this area of tension and explores not only the potentials of waste heat use, but also additional electricity demand through steadily advancing digitalisation.

The study illustrates, that over the next few years it will be key to improve the interfaces between actors and sectors: between companies ("energy communities"), between industry and grid/energy supply company/neighbouring settlement areas and between the sectors heat-electricity-gas-mobility through e.g. power-to-x and possible uses of hydrogen. The paper concludes with a concept for integrating urban manufacturing optimally in the urban energy system for a sustainable energy transition in the future.

Keywords:

Urban Manufacturing;
Waste heat;
Austrian cities;
Digitalisation;
Sustainable energy systems

URL: <http://doi.org/10.5278/ijsepm.3347>

1. Introduction

In the last decade, the trend towards re-industrialisation has become noticeable in developed cities, including many Austrian cities such as Vienna, Linz and Steyr. It has been increasingly recognized that the industrial sector is one of the key drivers for economic growth and jobs [1] which is also relevant for cities [2]. However, urban manufacturing has to deal with specific framework conditions in cities due to high density resulting in little space and high rental prices, close neighbourhood to residential areas and difficult traffic conditions. Thus, integrating urban manufacturing (UM) into the urban fabric as smoothly as possible, is a must for keeping UM in cities. This also addresses the energy system where an optimisation of demand and supply with high

energy efficiency and renewable energy sources (RES) integration must be strived for.

This paper presents the results of a study on "Energetic effects of urban manufacturing in the city - ENUMIS" [3] conducted for the Austrian Ministry for Transport, Innovation and Technology (BMVIT) funded within the research programme "Cities of Tomorrow". The ENUMIS study focuses on two key questions: 1) How can framework conditions be created to keep manufacturing companies in cities or to promote the establishment of new industry? 2) Which waste heat utilisation potentials from industrial and commercial enterprises are available in selected Austrian municipalities and which changes on the energy supply side can be expected from UM? Based on the study results, the paper explores future opportunities as well as challenges arising from

*Corresponding author - e-mail: tanja.toetzer@ait.ac.at

Acknowledgement of value

Cities of tomorrow need to become sustainable, liveable and prospective. One of the key topics is “urban production”. From an ecological, economic and social point of view, it is more sustainable to produce within the city. The program "City of Tomorrow" is researching and developing new technologies and solutions for future cities and urban developments. Its focus lies on the reduction of energy consumption and the use of renewable energies in buildings and city quarters as well as increasing the quality of living within cities.

The study provides orientation in the context of urban manufacturing and makes a first contribution to the technical involvement of relevant actors in the manufacturing sector. The results will help us to develop political measures for the development of new sustainable energy systems and will share first recommendations how to better connect research institutions with companies and energy suppliers.

Theodor Zillner, Austrian Ministry for Transport, Innovation and Technology. Energy and Environmental Technologies

UM regarding the design of sustainable energy systems for cities.

UM is understood as producing industry that is city-compatible, mixable, embedded in a digital environment, research-intensive and which generates high added value in the city [2]. The benefits of UM are seen in avoiding increasing delivery routes, high land consumption and a better integration and usage of renewable energies [4]. However, cities in transition and global trends are changing the type of production (Industry 4.0, digitalisation, electrification) as well as the industry structure (tertiarisation, convergence of services and production). For keeping UM in the city or even attracting new companies, the provision of a sustainable and secure energy supply is essential. The big challenge is to anticipate changes in the energy demand (and production) of UM and to optimally integrate UM into the urban energy system. Our study addresses exactly this open issue for selected Austrian cities. It is based on two previous studies on UM, which had been carried out by Fraunhofer Austria (FhA) [5] and superwien urbanism ZT OG [6] who were both partners in our project. In the course of these studies a structural analysis of the urban industry had been conducted and the future of UM in cities had been analysed. Our ENUMIS study brings this knowledge into an energy context and explores the effects for the urban energy system. Considering the structural changes, the study researches potentials for waste heat use as well as additional electricity demand expected through steadily advancing digitalisation. This delivers a comprehensive overview of the effects of these new requirements on the energy system but also of new options for energy supply.

The paper is organized along 4 sections. After this introduction the results of quantitative and qualitative analysis conducted in the study will be presented in section 2. On the one hand, expert interviews and stakeholder workshops with representatives from industry, companies, research and city administration had been conducted for identifying the key issues and discussing opportunities and potentials in a future sustainable energy supply through UM from a practical point of view. On the other hand, the energetic impacts of UM were examined more closely and waste heat potentials from industry and commerce in selected Austrian cities were estimated. These results feed into defining the role of digitalisation in UM for the future energy transition which will be presented in section 3. Special focus is laid on the potentials and challenges for UM through digitalisation and industry 4.0 and its implications on the urban energy system. Finally, in section 4, the paper concludes with a concept for integrating UM optimally in the urban energy system for a sustainable energy transition in the future.

2. Potentials of UM for the energy system

The City of Vienna commits itself to the provision of attractive and affordable locations for urban production and innovation and aims for an adequate land development strategy with the development of the thematic concept „Productive city” [2]. However, challenges that UM brings are to be found in the field of transport, economy and environment (emissions): UM causes traffic in the entire city which can lead to considerable traffic obstructions and congestion in mixed residential

areas where UM is per definition mainly located. Considering the economic pressure on the cities, land is mostly dedicated to residential use rather than industrial use, as higher profits are to be expected. This leads to the fact that it is becoming more and more difficult for companies to settle in urban areas and find affordable land. However, interviews and workshops with representatives from industry, urban planning, neighbourhood management, energy suppliers and manufacturing companies made clear that UM not only holds challenges, but also promises opportunities and potentials. A location in the city offers direct proximity to customers and highly qualified expert staff which promotes productivity. In the context of energy, the mixed land use is an opportunity for using renewable energies in a local heat network. In new urban areas, the use of locally available renewable energy sources can be promoted by an obligatory energy concept. Furthermore, the definition of the energy supply in the zoning plan or urban planning concepts could ensure the use of locally available energy sources. In general, using energy-political regulatory mechanisms supports the beneficiary use of the synergies from UM. However, it is crucial that the political will on the part of the city is given and a “caretaker” in the company or neighbourhood/town district shoulders the responsibility to engage the stakeholders and to facilitate the process.

In parallel to the qualitative analysis of the potentials, the energetic impacts of UM were examined more closely and waste heat potentials from industry and commerce in selected Austrian cities were estimated using a bottom-up approach. The already available studies are usually based on four basic methods: using publicly available carbon dioxide emission data from the European Pollutant Release and Transfer Register (E-PRTR) [7], estimating the efficiency of the plants, machines and processes [8], sending out questionnaires [9] or doing measurements. Since most companies’ data on energy consumption are not publicly available, the methodological approach, that had been developed in the previous project HEAT_re_USE.Vienna [10], was applied. It is based on open data from the Austrian statistical office (number of employees) to calculate industry-specific energy consumption (detailed description in [11] [12]). From this, the amount of waste heat was estimated proportionately, differentiated by sectors as well as by low, medium and high temperature classes. The approach follows these steps:

- 1 Choosing relevant business sectors based on the NACE classification (European classification of economic activities)
- 2 Assessment of the energy consumption based on employee-specific energy parameters (kWh/employee)
- 3 Assessment of the waste heat potentials assuming a sector-specific shares of the energy consumption to be available as waste heat

Due to the use of characteristic sector-specific average values, the waste heat potentials can only be estimated at a rough level. Thus, a detailed examination (measurement, real consumption figures etc.) is necessary in the next step. However, the rough analysis gives a good overview of possible existing potentials and hotspots in the city, which should be considered in detail.

Figure 1 presents the results of selected sectors of the waste heat potential estimation in 8 Austrian cities investigated. The waste heat potentials were evaluated according to their future usability and are therefore divided into the following temperature level classes (1) Low temperature (30-100°C), which is directly in low temperature systems (e.g. underfloor heating) or can be raised to higher temperature levels by heat pumps (2) Medium temperature (100-500°C), lower ranges can be directly fed into a district heating system, higher ranges can be used for converting into electrical energy (3) High temperature (> 500°C), can be directly used for conversion into electrical energy or must be cooled for feeding into a district heating network.

Generally, some sectors such as bakeries and laundries are well suited for a location in the city, while companies in the chemical, rubber and plastics, paper or iron and steel sectors are more likely to settle on the outskirts or in the countryside due to high emissions or space requirements. Nevertheless, the analysis shows that some companies from these sectors can still be found within the city borders. In most cases they have traditionally been at this location for many years or even decades and waste heat could be used to heat neighbouring residential or industrial areas. To discuss the results of the analyses and to receive input from a practical point of view, opportunities and potentials in the area of a future sustainable energy supply through UM were discussed in a stakeholder workshop. The participants gave valuable input to round off the picture derived from desk research and quantitative analysis.

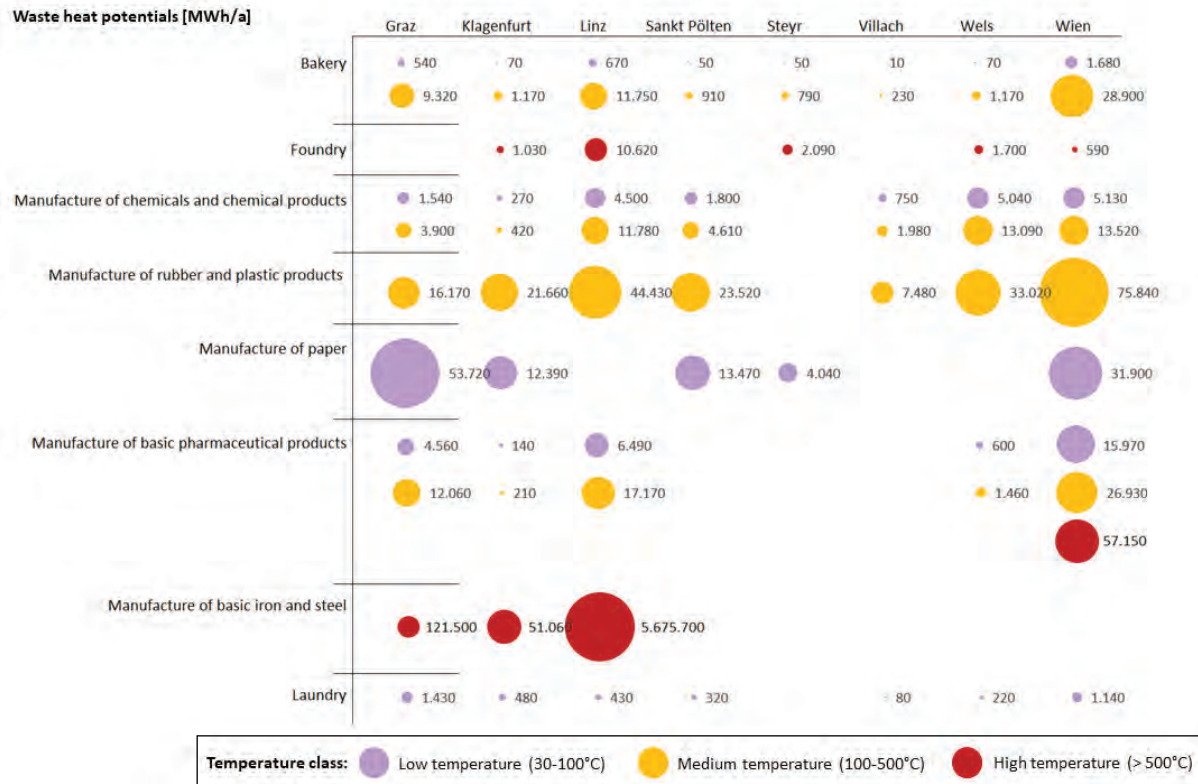

Figure 1: Waste heat potentials of 8 selected Austrian cities differentiated by three temperature classes in MWh/a, own illustration

3. The role of digitization in UM for the future energy transition

According to the Austrian Climate and Energy Strategy [13], the objective is to cover 100% of total electricity consumption (national balance) from national renewable energy sources by 2030. With currently 72% share (status 2017) [14] of renewables for electricity generation, Austria is well ahead in the ranking of EU [13]. However, the Austrian industry sector has a high proportion of energy-intensive basic industry and is still highly dependent on fossil fuels. In 2017, the energy and industry sector accounts for about 45% of the total greenhouse gas emissions in Austria [15]. Energy saving, energy efficiency, integration of renewables and electrification will be key elements for an industrial energy transition [15] and go hand in hand with digitalisation.

The global trend of digital transformation affects UM which will transform to service-oriented production [16, 17]. This change must also be accompanied by a change in the energy supply system. The share of electricity in the energy mix of households and services has risen significantly since 1970. In the future, electricity consumption will increase both in absolute terms and as a

proportion of total final energy consumption meaning that the importance of electricity as an energy source will increase [18].

Due to the wave of digitization, which is often described as “Industry 4.0” in the manufacturing environment, the manufacturing sector is undergoing a significant change. It enables the expansion of renewable energies via controlling and regulation of the system to meet the challenges of decentralisation and flexibilization [13]. New technologies and developments such as cyber-physical systems, higher automation, human-robot collaboration, cloud solutions and increased computing power also present opportunities for UM. Digitization is often referred to as the enabler of the energy revolution and offers opportunities to transform the energy sector into the digital age [19, 20]. This leads to the rollout of intelligent measurement systems (smart meters) and the use of smart grids, which enable load management within the distribution network.

Although potentials are high, actual future development and true effects of digitalisation on the energy demand are associated with a high level of uncertainty. Experts are not yet sure how digitization will affect the

overall energy consumption. In the study “Digital Transformation to the Energy World” [21] carried out by the Austrian Energy Agency in 2017, around 40 experts were asked about how digitization will affect the energy demand. 35% believe in an increase, 47% think the energy demand will not change and 15% believe in a decrease. The International Energy Agency [20] estimates that energy saving potentials of about 10% can be reached through smart technologies in the buildings sector. In industry further efficiency potentials are particularly seen by improved process controls, 3D-printing, machine learning and enhanced connectivity. However, although the potential savings can be leveraged through digitization, they are overshadowed by rebound effects and the additional demand generated. Research already focusses on how to manage the growing energy by information and communication infrastructures [22]. Experts agree, however, that only digitization will enable the broad expansion of decentralised renewable energy sources and the necessary flexibilization of energy demand [20, 21] and can initiate a backshoring of manufacturing activities back to the European market [23].

In this context data centre play an essential role – they are the backbone for digitalisation and closely interwoven with Industry 4.0. As such they are becoming relevant components in the energy system of UM. The world-wide energy demand of data centres is assumed to be about 1.5% of the world’s electric power consumption and is increasing significantly in the future [24]. As all this energy is ultimately transformed into thermal

energy, waste heat recovery is a considerable mean to reduce their environmental footprint. Stockholm provides a good practice example where a data centre operator (DigiPlex) and heating and cooling supplier (Stockholm Exergi) signed a heat reuse agreement for heating up to 10,000 modern residential apartments with recovered data centre waste heat [25].

4. Concept for integrating UM optimally in the urban energy system & Conclusions

The previous research fed into the development of a concept for integrating UM optimally in the urban energy system illustrated in Figure 2. It illustrates that new requirements occur through changes in type of production and in the industrial structure which lead to new demands on energy supply (both electricity and heat). Changing energy demand from UM can be related to e.g. digitalisation in traditional UM sectors or to new sectors like 3D printing, vertical farming or data centres which become an essential precondition for UM. New options for the urban energy system arise through changing roles of UM to a prosumer and producer of waste heat and RES. The trend is clearly in the direction of blurring the boundaries between consumers and producers, between heat, electricity, gas and mobility sectors (sector coupling) and between commercial/industrial and residential sectors. As also Heinisch et al. [26] state in their work, the electricity, heating, and transport sectors in urban areas all must contribute to meet the

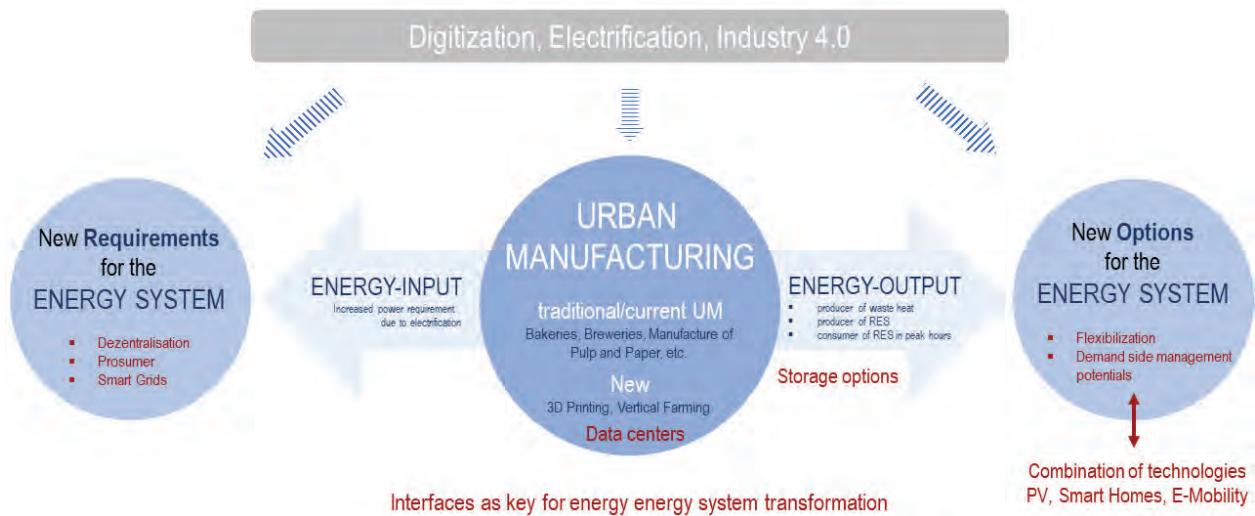

Figure 2: Concept for integrating UM optimally in the urban energy system, own illustration

climate targets. In this context, storage options are becoming increasingly important. This makes it possible to bridge energy generation and demand over time, make better use of fluctuating renewable generation, balance short-term load fluctuations and control production processes in a grid-stabilizing way. UM companies can offer different potentials depending on the sector and production process: many companies need most of the energy during the day, at times when demand from households is low; some have the potential to adjust their production (e.g. in batch processes) to when a lot of energy is available and cheap (power-to-product); they have storage potentials (heating and cooling processes (power-to-heat/cool), own storage) and the possibility to produce and make and offer heat and electricity themselves.

The increased use and integration of renewable energy sources that also come from UM in the energy system create additional new requirements for the energy system. Sector coupling is seen as a key concept of the energy transition and in building carbon-free energy systems [13]. Previously separate systems, the energy consuming sectors buildings (heating and cooling), transport and industry are interlinked with the power sector. The increasing use of electricity from renewable energy sources in all sectors supports the decarbonisation of the energy system but is also associated with new challenges.

According to the Masterplan 2050 from the Swiss municipal utility Swisspower [27], this system change requires a paradigm shift: “In order to efficiently coordinate the large number of new, decentralized energy producers, an intelligent local management of supply and demand across all energy sources is needed.” In the future, the network infrastructure will have to take a balancing and storage function in addition to its transport function and balance fluctuations in energy generation from volatile sources such as wind and sun. All systems must exchange information with each other on an ongoing basis in order to achieve optimal results. The Viennese distribution system operator Wiener Netze GmbH will also focus on similar topics in the future. Smart grids and digitalisation, which enables communication between the individual plants and grids, can significantly optimise grid planning and forecasting, provided that the data is available at all times. Smart grids should also make it possible to consume electricity exactly when it is generated primarily by renewables [28]. Smart technologies are intended to provide both

utilities and consumers with the ability to control their systems. The focus will be on the rollout of smart meters and smart homes in order to develop urban smart districts like e.g. in Rome [29]. As a result, data volumes will increase, and more computing power and storage space will have to be made available.

Beside new requirements also new options for the energy system occur (right side of Figure 2), including the possibility of using waste heat from industrial processes. Companies can become energy sources for local microgrids and provide power and heat for other businesses or neighbouring settlements. Among other things, there is also the possibility to generate electricity from waste heat (at low temperature for example via ORC processes) or to feed PV from hall roofs into a local grid. In addition to billing-related issues (billing via blockchain, fees for the use of the public grid), legal issues also arise (electricity seller becomes an energy supplier with associated obligations).

In addition to the production of renewable energy, UM can also become a consumer of a surplus of renewable energy. Either because they can directly use the electricity in production processes at RES peak times or save it for later. For example, heating or cooling processes could be carried out electrically at a time of high RES supply or discontinuous batch processes could be coordinated therewith (demand-side-management).

To focus more strongly on the new role of UM companies in the energy system, targeted district management and forward-looking energy planning (for example for low-exergy systems) can make a significant contribution. It offers assistance and a framework for the energy strategy in companies.

Concluding, research has shown that for most of the solutions, that UM would optimize from an energy perspective, the technological requirements are largely available. However, over the next few years, it will be necessary to intensify the testing of technologies in demonstration projects and to improve the interfaces between actors and sectors: between companies (“energy communities”), between industry and grid/energy supply company/neighbouring settlement areas and between the sectors heat - electricity - gas – mobility through e.g. power-to-x and possible uses of hydrogen. Demonstration projects on load management for heat and electricity, waste heat and surplus electricity use (power-to-heat) in industry should be pushed and be tested under real-life conditions to prepare for large-scale use in the future. The concept for integrating UM optimally in the urban

energy system for a sustainable energy transition in the future is already there. Now, above all, political will and implementations for testing and realising optimal technological solutions for UM in a sustainable urban energy system is needed.

Acknowledgements

This article was invited and accepted for publication in the EERA Joint Programme on Smart Cities' Special issue on *Tools, technologies and systems integration for the Smart and Sustainable Cities to come* [30].

References

- [1] European Commission, Communication from the Commission to the European Parliament, the Council, the European economic and social committee and the Committee of the regions, For a European Industrial Renaissance, {SWD(2014) 14 final}, (2014). <https://eur-lex.europa.eu/legal-content/EN/TXT/PDF/?uri=CELEX:52014DC0014&from=EN>
- [2] MA 18, Fachkonzept Produktive Stadt [Technical Concept Productive City]. Vienna (2017). <https://www.wien.gv.at/stadtentwicklung/studien/pdf/b008500a.pdf>
- [3] Tötzer T, Stollnberger R, Krebs R, Haas M, Biegler C, Energetische Auswirkungen von Urban Manufacturing in der Stadt, Berichte aus Energie- und Umweltforschung [Energetic Impacts of Urban Manufacturing in the city], 17/2019, (2019). https://nachhaltigwirtschaften.at/resources/sdz_pdf/berichte/schriftenreihe-2019-17-enumis.pdf
- [4] Mayerhofer P, Wiens Industrie in der wissensbasierten Stadtwirtschaft [Vienna's industry in the knowledge-based city economy], Vienna (2014). https://wien.arbeiterkammer.at/service/studien/stadtpunkte/Stadtpunkte_10.pdf
- [5] Fraunhofer Austria Research GmbH and Fraunhofer - IML, Urban Manufacturing – Die Zukunft des sekundären Sektors in Wien [The future of the secondary sector in Vienna], report on behalf of the Chamber of Commerce Vienna. Vienna (2014), not published.
- [6] Jung-Waclik S, Katzler-Fuchs S, Krebs R, Schechtner K, Urban Manufacturing - Herausforderungen und Chancen von Urban Manufacturing für Österreichische Städte [Urban Manufacturing - Challenges and Opportunities of Urban Manufacturing for Austrian Cities], Vienna (2016). https://issuu.com/rolandkrebs/7/docs/20161222_urban_manufacturing_rk
- [7] Persson U, Quantifying the Excess Heat Available for District Heating in Europe, Sweden, (2015). <https://heatroadmap.eu/wp-content/uploads/2018/09/STRATEGO-WP2-Background-Report-7-Potenital-for-Excess-Heat.pdf>
- [8] Waste-heat, Manual for the estimation of regional waste heat potential, (2019). <https://www.waste-heat.eu/waste-heat-potential/manual-for-the-estimation-of-regional-waste-heat-potential>
- [9] Enova, Potensialstudie Spillvarme [Potential Study Waste heat] (2009). https://www.enova.no/download/?objectPath=upload_images/44EB7A65846B4824A6EB704198C3F6BC.pdf
- [10] Loibl W, Stollnberger R, HEAT_re_USE.Vienna, Sondierung zur systematischen Nutzung von Abwärmepotenzialen in Wien [Exploration for the systematic use of waste heat potentials in Vienna], (2016). <https://smartcities.klimafonds.gv.at/wp-content/uploads/sites/3/BGR010-2017-SC-2.pdf>
- [11] Loibl W, Stollnberger R, Österreicher D, Residential Heat Supply by Waste-Heat Re-Use; Sustainability, MDPI, 9 (2), 250; <http://doi.org/10.3390/su9020250> (2017) pages 119.
- [12] Stollnberger R, Industriell-gewerbliche Abwärmepotenziale und deren Nutzung für eine energieeffiziente Entwicklung im Stadtgebiet von Wien [The potential of industrial and commercial waste heat supply and its usage for an energy efficient urban development within the City of Vienna], Wien, (2016).
- [13] BMNT & BMVIT, Mission 2030, Klima- und Energiestrategie [Austrian Climate and Energy Strategy]. Vienna (2018). <https://mission2030.info/wp-content/uploads/2018/06/Klima-Energiestrategie.pdf>
- [14] BMNT, Energie in Österreich [Energy in Austria], (2018). https://www.bmnt.gv.at/dam/jcr:3db9b813-8c0f-49fd-b5ff-89e9600c3cd7/Energie_in_OE2018_Barrierefrei.pdf
- [15] Geyer R, Knöttner S, Diendorfer C, Dexler-Schmid G, IndustRiES – Energieinfrastruktur für 100% Erneuerbare Energie in der Industrie, [Energy infrastructure for a 100% renewable energy in industry] Study on behalf of the Austrian Climate and Energy Fund (2019). https://www.klimafonds.gv.at/wp-content/uploads/sites/6/Studie_IndustRiES-2019_RZ.pdf
- [16] Peneder M, Firgo M, Streicher G, Stand der Digitalisierung in Österreich [State of digitalisation in Austria], (2019). https://www.wifo.ac.at/jart/prj3/wifo/resources/person_dokument/person_dokument.jart?publikationsid=61654&mime_type=application/pdf
- [17] Mühl C, Busch H.-C., Fromhold-Eisebith M, Fuchs M, Urbane Produktion, Dynamisierung stadtreionaler Arbeitsmärkte durch Digitalisierung und Industrie 4.0 [Urban production, dynamisation of urban labour markets through digitalisation and industry 4.0], (2019). https://www.fgw-nrw.de/fileadmin/user_upload/DvA_14_Studie_Muehl_et_al._web.pdf
- [18] Österreichische Energieagentur, Visionen 2050 [Visions 2050], (2010). https://www.energyagency.at/fileadmin/dam/pdf/publikationen/berichteBroschueren/Visionen2050_Executive_Summary.pdf

- [19] Ernst&Young GmbH, Der Verteilnetzbetreiber der Zukunft – Enabler der Energiewende, Stadtwerkstudie 2017 [The Distribution System Operator of the Future - Enabler of the Energy Turnaround, Study of the Public Utility Company 2017], (2017). https://www.bdew-kongress.de/files/bdew_kongress_verteilnetzbetreiber_ey_stadtwerke_studie_2017.pdf
- [20] International Energy Agency (OECD, IEA), Digitalization and Energy, IEA Publications, (2017). <https://www.iea.org/publications/freepublications/publication/DigitalizationandEnergy3.pdf>
- [21] Austrian Energy Agency, Digitale Transformation der Energiewelt – Ergebnisse einer Umfrage bei österreichischen (Energie-)Unternehmen [Digital Transformation of the Energy World - Results of a Survey of Austrian (Energy) Companies], (2017). https://www.energyagency.at/fileadmin/dam/pdf/publikationen/Studien/AEA_Digitale_Transformation_der_Energiewelt_Mai_2017.pdf
- [22] Morley J, Widdicks K, Hazas M, Digitalisation, energy and data demand: The impact of Internet traffic on overall and peak electricity consumption. *Energy Research & Social Science* 38 (2018) pages128137. <https://www.sciencedirect.com/science/article/pii/S2214629618301051>
- [23] Dachs B, Kinkel S, Jäger A, Bringing it all back home? Backshoring of manufacturing activities and the adoption of Industry 4.0 technologies, *Journal of World Business* 54 (2019) 101017. <https://www.sciencedirect.com/science/article/pii/S1090951617309008>
- [24] Hintemann R, Hinterholzer S, Technology radars for energy-efficient data centers: A transdisciplinary approach to technology identification, analysis and evaluation. Presented at the World Congress on Sustainable Technologies, Cambridge: Institute of Electrical and Electronics Engineers (IEEE), (2018). https://www.borderstep.de/wp-content/uploads/2019/01/Hintemann_Hinterholzer_WCST_submitted.pdf
- [25] Press release, DigiPlex data centre to heat 10 000 Stockholm households, 2018. <https://www.digiplex.com/resources/nyheter/DigiPlex-Heat-Re-use-Partnership.Eng.pdf>
- [26] Heinisch V, Göransson L, Odenberger M, Johannson F. A city optimisation model for investigating energy system flexibility. *Int J Sustain Energy Plan Manag* 2019;24. <http://doi.org/10.5278/ijsepm.3328>
- [27] Swisspower, Energiesystem der Zukunft, Umsetzung des Swisspower Masterplans 2050 [Energy system of the future, implementation of the Swisspower Master Plan 2050], Zürich 2015, (2015). <https://swisspower.ch/content/files/publications/Masterplan-PDF/Energiesystem-der-Zukunft.pdf>
- [28] Wiener Netze GmbH, Interview, (2018).
- [29] Romano S. Experimental demonstration of a smart homes network in Rome. *Int J Sustain Energy Plan Manag* 2019;24. <http://doi.org/10.5278/ijsepm.3335>
- [30] Østergaard PA, Maestosi PC. Tools, technologies and systems integration for the Smart and Sustainable Cities to come. *Int J Sustain Energy Plan Manag* 2019;24. <http://doi.org/10.5278/ijsepm.3450>



RESEARCH and EXPERIMENTATION

Sustainable Energy Management: Are Tourism SMEs in Poland ready for Circular Economy solutions?

Marta Jaroszewska^{a*}, Patryk Chaja^a and Anna Dziadkiewicz^b

^a Department of Distributed Energy, Institute of Fluid-Flow Machinery Polish Academy of Sciences, Fiszerza 14 St., 80-231 Gdańsk, Poland

^b Marketing Department, Faculty of Management, University of Gdańsk; Armii Krajowej 101 St., 81-824 Sopot, Poland

ABSTRACT

As a key aspect of tourism competitiveness, sustainability plays an important role in profiling Europe as a tourism destination in key source markets. As in any other region(s), comprehensive engagement and involvement of key stakeholders plays an essential component and role in developing Europe as a sustainable tourist destination. This type of engagement and involvement requires a cross-border collaboration in order to establish a common region identity as a means of managing complex processes of globalization. The initial requirement for such an interaction is to identify appropriate relevant stakeholders for European sustainable tourism and to facilitate cross-border dialogue and interactions.

In the field of energy, it is important to take into consideration both energy sustainability and energy efficiency. Energy effectiveness can be described as the interaction between energy produced and energy induced/invested. Sustainable energy can be assessed from the perspective of consumption/production or the impact it has on the environment and society.

This study focuses on level of implementation of circular economy in the energy sector of tourist SMEs in Poland, which can be also understand as a level of implementation of ideas such as high efficiency energy systems and sustainable energy management. The area of research is Polish coastal area, which is a part of the South Baltic Region. This Region has exceptional potential for becoming a forerunner in achieving sustainable tourism goals of the EU. Utilizing the “sustainable energy theory”, the purpose of this research is to examine energy management problems with regard to sustainable development for SMEs involved in Polish tourism in the South Baltic Region.

A structured interview method was used as well as a comparative analysis method. The main conclusion is that the tourism sector in Polish part of South Baltic Region is, at different levels, ready to implement a change from linear economy in the context of energy. In the case of Poland although there are some challenges, it is still very encouraging in that people are beginning to see and view sustainable management, whatever the problems or solutions, as a core living item and not something that can be ignored or pushed aside any longer.

Keywords:

Sustainable energy;
Tourism SMEs;
Energy system planning;
Circular economy;
Model of sustainable energy management;

URL: <http://doi.org/10.5278/ijsepm.3342>

1. Introduction

The EU tourism development policies are mainly focused on driving Europe towards maintain its competitive position as a leading tourism destination worldwide but at the

same time developing more sustainable tourism forms. However this is only possible if tourism-related Small and Medium Enterprises (SMEs) implement sustainable management solutions in terms of both technological and

*Corresponding author - e-mail: marta.jaroszewska@imp.gda.pl

Acknowledgement of value

Sustainable energy management in Polish tourism will take its roots from the principles and concepts of the circular economy. Once the inventory of resource stocks and energy flows is established, we will co-design and shape a concept of circular tourism preserving Polish landscapes and local knowledge/cultures (Circular Economy 2.0).

Energy will where possible be of renewable sources and therefore local tourism will be planned taking into account the distribution nature of these sources. Low technologies enabling solutions with lower energy consumption will be preferred because there are more resilient.

Energy design for Polish tourism will aim at not only producing enough energy for the needs of the related activities, but will also aim at feeding and transferring extra energy back into the local network for local citizens to make use of free of cost (ecosystem benefits).

Alexandre Lemille, advocate of a Circular Economy 2.0, adviser on EU H2020 and Interreg projects:

non-technological innovations. In this regard, understanding tourism SMEs' perceptions about the challenges they face for implementing sustainable development strategies and what is required to overcome such challenges is essential. During the past thirty years, many concepts such as eco-thinking, sustainable development, sustainability, and green growth have been introduced to solve global problems, related to the prevailing increase of consumption, and mass growth-oriented production [1–4]. The CE concept covers different actions that can be taken, some of which are: introducing new technologies [5], changes in national policies [6], demonstration of good-practices [7] or influence and role of people towards changes in energy systems [8–10]. The circular economy (CE) concept, on which this article is based on, is of great interest to both academia and practitioners, because it is viewed as operational and feasible for businesses to implement sustainable development [11,12].

It cannot be traced back to one single date or author rather to different schools of thought. The CE is considered to have been introduced by the economists David Pearce and R. Kerry Turner [13], who defined a set of principles which were different from the linear 'take-make-dispose' model, based on continuous economic growth. The main aim of the circular economy is considered to be economic prosperity followed by environmental quality but its impact on social equity/equality and future generations is barely mentioned [14]. According to the European Commission [15], some of the ways to achieve resource efficiency include light-weighting, durability, efficiency, substitution, eco-design, industrial symbiosis, and leasing or renting.

According to the Ellen MacArthur Foundation [16], most approaches such as "cradle to cradle", biomimicry and blue economy have contributed to further refine the concept of CE. Thus the CE goes further than just 'eco-thinking', 'sustainable', 'green', and environmentally-friendly technologies. The CE relies on value creation through reduction, re-use, recycling and recovery of resources, enabled through new types of business models and forms of consumption that create and enhance to becoming active 'users' rather than passive 'consumers' [17]. Nowadays, there are numerous examples of activities that promote the development of business innovations, consistent with sustainable development [18].

The CE concept is an attempt to transition the product-oriented business model in which enterprises are focused on the product into a model based on services [19]. This system is often called product-service system (PSS) and it imposes upon the enterprises the product life extension, considering the fulfilment of customers' needs [18] together with solving their problems.

From the business perspective, the circular models involve both, so-called soft-changes such as:

- skills and knowledge, including entrepreneurship and capacity-building;
- organisational innovation, including integrated solutions and systems, logistics, business models, and policy supporting tools;
- social innovation, including: new production and consumption models, citizens' involvement, product service models, and design services;
- financial instruments;
- awareness, dissemination and internationalisation;

- multi stakeholder involvement, and technological innovation, including: design of materials and processes, product design, and resource management.

The aim of this article is to identify the key problems for the tourism SMEs with their energy systems and proposes solutions that can be implemented. It therefore investigates the readiness of the tourism sector SMEs from the South Baltic Region for implementation of the change from linear economy to circular economy with the specific focus on energy in Poland. The types of SMEs that are taken into account are: hotels, restaurants and spas.

The paper’s structure is as follows

- In Section 2 the role of energy in the circular economy is described and it characterizes the present level of adaption by the SMEs from the South Baltic Region relating to the rules of circular economy in the context of energy
- Section 3 describes the method of inquiry to collect the biggest challenges.
- In Section 4 the results of inquiry are presented.
- Section 5 concludes the paper.

2. The role of energy in the circular economy

The role and purpose of this paper is to investigate the level of readiness for circular economy and because of the fact that energy is part of circular economy it is mainly associated with energy efficiency and therefore we should also mention the known barriers to energy efficiency. These barriers are:

1. Risks (e.g. financial risk in investing in new technologies)
2. Imperfect information (lack of information and knowledge of “best practices” on technologies and solutions that may be used to improve energy efficiency),
3. Hidden costs (e.g. project inadequate to the needs of investor which affect because of additional costs, or costs that are costs of implementing the solution itself such as the training of staff),
4. Access to capital,
5. Split incentives (e.g. the need of investor/owner of the company differ from the need of employee) and

6. Fixed and bound rationality (e.g. no need towards looking for the best solution but choosing the first that meets the demands).

All of the six above mentioned barriers affect the problems involved with the implementation of changes in the energy system, and thereby are also considered in this work, SMEs [20].

CE allows for economic development while minimising the consumption of raw materials, waste production, emissions and energy losses through the creation of advanced chains of manufacturing and consumption processes in which production waste is used as raw materials [21,22].

In the case of the energy industry, the CE focus on the optimization of three basic aspects [23]:

- a. Use of energy sources - energy production
- b. Use of by-products and excess energy - cooperation between manufacturing industry and cooperation at the urban level
- c. Energy consumption by the final recipient - relation and communication with the client

Visual representation of the role of energy in CE is presented in Figure 1.

In the processes of CE, following activities can be distinguished:

- Design of manufacturing processes and services, e.g. planning of recycling of materials created in the production of energy
- Energy production, e.g. use of renewable and waste energy, energy conversion



Figure 1: The role of energy in circular economy [24]

- Recovery of energy inventory, e.g. recycling of materials from generating units as energy or raw materials
- Waste disposal, e.g. disposal of unused waste

The influence of CE economy on the cooperation of the manufacturing industry and cooperation at the municipal level, for example:

- Utilization of by-products of the manufacturing industry (e.g. oil, biogas)
- The use of redundant energy created in the manufacturing industry (e.g. heat from a smelter)
- Use of ash (production of fertilizers)

In the CE processes for cooperation with the final recipient, we distinguish activities related to:

- Energy distribution, e.g. smart grid products and services
- Services, e.g. heating, electricity, lighting as a service (performance fee, e.g. 22°C home temperature), other services related to the functioning of real estate, services ensuring energy efficiency
- Final energy consumption, e.g. response to demand (e.g. reduction of demand (e.g. demand response and load reduction), bilateral exchange of electricity and heat, use of waste heat of building ventilation (e.g. from heat pumps). This is a typical demand side response (DSR) service. DSR is focused on intelligent energy use. Through demand side response services, businesses and consumers can turn up, turn down, or shift demand in real-time.
- Virtual production unit/ virtual power plant - the solution allows for reliable and easy participation of many companies on the balancing market.

It can be easily stated that ideas stand that stand behind the role of energy in circular economy are among others: high efficient energy systems, sustainable energy management and implementing technologies based on renewable sources as well as sustainable use of available resources.

It is worth noting at the end of this paragraph, that in the era of exhausting natural resources and progressing urbanization, the CE is the only viable direction for the sustainable development of the world.

2.1. The Status

This paper analyses the situation in Poland in this regard, observed during the implementation of Cirtoinno project, which was realised in South Baltic Region



Figure 2: Visual representation of the South Baltic Region [25]

covering areas of Sweden, Denmark, Germany, Poland and Lithuania (Figure 2) under the EU Interreg Programme.

Research shows, that there is a huge variety and disparity in the level of implementation of circular economy rules in the context of energy by SMEs from the tourism sector [26,27]. It is also not surprising that those countries with greater sources of renewable energy use with a higher level of awareness of climate change (or even climate crisis and which is more and more commonly used in literature [28]) are also the countries where the level of implementation of circular economy is higher. This is especially evident in regards to Sweden and Denmark. Accordingly the countries with lower sources renewable energy and lower awareness of climate change are also the countries with a lower level of implementation of circular economy.

In this paper the authors focused on analysing the situation of Poland. Generally it can be stated, that in Poland the level of implementation of circular economy is low. When asking business owners from the tourism sector about circular economy, the reply shows, that most often they are unaware of the term or that they do not have a clear picture as to what circular economy really is¹. However in the context of energy, business owners make use of circular economy even if they are not aware of it. Poland with its continuously changing regulations and indeed changes in the energy sector may

¹The statement is based on the results from the survey, which was a part of realized project, entitled Cirtoinno: Circular Economy Tools to Support Innovation in Green and Blue Tourism SMEs, Work Package 4 (Project No. STHB.01.02.00-22-0058/16), under the Interreg South Baltic Programme, 2016-2019. A model of sustainable energy management projected on the basis of design thinking approach and then tested during an advisory service among 96 tourism SMEs in the South Baltic Region, including 28 SMEs from Poland was one of the outputs. The structured interview method was used in the paper as well as a comparative analysis method

not be easy for investors although there some supporting users , especially for SMEs that can help to produce more innovative solutions in businesses as well as implementing training and workshops (for business owners and for employees) in order to increase the level of awareness of energy, climate change and solutions that can be used in hotels, restaurants and/or spas.

3. Methods

Having understood the general level of implementation of circular economy by the tourism-related SMEs the next step is to identify the key problems, that drive investors from implementing ongoing trends. It is also important to identify what level of awareness business owners have for solutions in circular economy concerning energy. The method chosen for collecting data is a questionnaire filled by the tourism SMEs from the South Baltic Region. Due to the specific characteristics of different countries from the South Baltic Region it was decided, that for the purpose of this paper only tourism SMEs from Poland will be addressed in the questionnaire. The aim of this part is only to present research results concerning implementation of circular economy solutions for energy in Polish enterprises situated in the South Baltic Region of Poland. The study was carried out as part of an international project Cirtoinno with projects partners from Poland, Sweden, Denmark and Lithuania in the period 2017-2019.

A structured interview method was used in the paper as well as implementing a comparative analysis method. The research was conducted in 2018 among 98 enterprises representing the tourism business. The enterprises were asked questions regarding their business model, energy (heat, cold), water, transport, flow of resources, chain of suppliers, management, water, waste management as well as questions regarding behaviour of owners, employees and clients/quest ad knowledge regarding circular economy. As the entire study is too broad to be presented here the authors have selected only parts of the results relevant to the subject of the paper. The questionnaire part regarding energy contains 16 open questions, the same for all three types of SMEs (hotels, restaurants and spas) and respectively 4, 2 and 1 additional open questions specific of the operation characteristics of hotels, restaurants and spas which gives total of 20, 18 and 17 questions respectively). The questions cover both the attitude towards circular economy methods regarding

energy for the owner and the employee as well as the behaviour, knowledge and readiness towards implementing changes for both guests and clients. Most of the questionnaires were sent to business owners who filled them in and sent back to the authors, while other conducted in the form of an interview. After that all of the answers were collected and analysed in order to find the key problems , that drive investors from implementing ongoing trends for circular economy. The type of analysis used is qualitative analysis. From all of the answers concerning the key problems in implementing circular economy solutions those that appeared most frequently were chosen and analysed. Also the areas where there is no problem in implementing circular economy solutions were identified (if existing). Description of the results is presented with the division for three groups, which are: heat, power and transport. Each of the subsections is structured first by outlining the areas where the level of readiness is high (if existing) and thereafter describing the areas where the challenges are similar for all three different types of SMEs and finally the challenges that are specific for the SME type (if existing). At the end of each subsection there are listed solutions for the companies that can be used to turn the company into one that works in line with circular economy in the context of energy.

4. Results

4.1 Heating

In this section, thermal energy will be described as well as the energy needed for hot water supply. In the region of heating there is no area where the level of readiness for implementing circular economy is high. It is observed that most companies are only aware of how much they pay for heating and for hot water and what is the source of heating, that they are using (district heating or individual heating). In most cases replies from the questionnaires indicated that their desire is to pay less for heating and hot water but that they also lack of knowledge on how to achieve this. Which is an example of “Imperfect information” barrier to energy efficiency. One of the biggest challenges mentioned by the companies was for the amount of investments that needs to be made in order to improve the energy system and increase energy efficiency. Even with financial help from support programs it still resulted in that in most of the cases the costs of such changes where still too great for the companies.

And that is barrier of “Access to capital”. Another challenge observed for all three types of SMEs was their unawareness as to the kind of changes, which should and/or could be made. Unfortunately the information which can be found in this area (eg. online) is often misleading. The challenge, and also example of “Imperfect information” is to understand the needs, such as: heating demand, hot water demand, resources available onsite and harnessing the system.

The following challenge, that companies face are the different kinds of problems concerning the building itself. Most of the changes in the energy system of the building need some level of additional construction work to be carried out. It was pointed out by some companies, that

there are cases, in which they are not the owners of the building and not the decision making parties and it is a challenge to persuade these parties to implement changes, which is a clear case of “Split Incentives”. In the case of old buildings construction work is not an easy task since it could well include for example: adding building insulation or installing renewable energy generation units, e.g. in Gdańsk Old Town it is not possible to install any photovoltaic panels on the roofs of old buildings.

The specific challenge for hotels is to optimize the usage of energy, which to a large extent is dependent on and influenced by their guests. It is not easy to control the energy usage of guests and that can be seen as a “Risk”

Changes requiring a low level of investment	Changes requiring a high level of investment
<ul style="list-style-type: none"> - Understanding bills, analysing thermal energy consumption and costs related to thermal energy and aiming to reduce thermal energy consumption - Identifying and verifying the main heat consumption and aiming to reduce the amount of energy consumed - Posting up and displaying information in appropriate places on how to use thermal energy more responsibly - Carrying out an energy audit - Selection of an operator offering energy produced from RES - Posting up and displaying information in appropriate places on how to responsibly use resources - Installing aerators limiting water consumption - Identifying the possibilities of reducing heat loss in a building 	<ul style="list-style-type: none"> - Purchasing devices of thermal energy production from renewable sources as well as becoming a prosumer - Using an intelligent thermal energy management system - Purchasing new water-consuming equipment (e.g. dishwashers, washing machines) - Modernizing the building in terms of reducing heat loss through e.g. utilizing building insulation - Thermo-modernisation, achieving a zero or positive energy output of a building

4.2 Power

As in the case of heating there is no area for power observed where the level of readiness to implement circular economy is high. Similarly, it is observed that most of the companies are aware of how much they pay for electricity. However in most cases they were not aware of how much electricity they were using every month/year and what’s more in some of the com-

panies there was even the problem of interpreting the electricity bills, which is a clear case of “Bounded Rationality”.

Similarly, the challenges faced by the companies were for example: a lack of funds (“Access to capital” for carrying out changes in the energy system as well as the problem of the energy system being highly depend on the behaviour of guests.

Changes requiring a low level of investment	Changes requiring a high level of investment
<ul style="list-style-type: none"> – Interpreting bills, analysing electricity consumption and electricity costs and aiming to reduce electricity consumption – Identifying and verifying the main source of energy consumption and aiming to reduce the amount of energy consumed – Posting up and displaying information in appropriate places on how to responsibly use resources – Carrying out an energy audit – Selecting an operator offering energy produced from RES 	<ul style="list-style-type: none"> – Purchase of devices producing electricity from renewable sources as well as becoming a prosumer – The use of an intelligent electrical energy management system

4.3 .Transport

Transport in the tourism sector may not seem obvious when talking about hotels, restaurants and spas, but during the questionnaire, stage authors realized that it plays a big role in these businesses. It is required for various purposes, e.g. transportation of goods needed for business operation, transportation of guests as well as in the entertainment for the guests.

It is worth mentioning, that transport is the only sector where the level of knowledge was shown to be high. From analysing responses in the questionnaire it can be seen that business owners (or managers) are aware of the different solutions, which may be used and that most of them also understand how they have been using these solutions in their businesses.

There is one main challenge that is faced by all three kinds of business types and that is the lack of funding/

funds that can be used for investments (“Access to capital”). There is a huge difference between vehicles that run on petrol or diesel and the e-vehicles and most of the time the costs of choosing a more ecological solution is too high. Also, when it comes to investing in solutions for entertainment for guests the biggest challenge is the cost.

The other challenge that was mentioned by certain companies was the requirement for power for the solutions that fit in circular economy, which is a good example of “Rissk” and “Hidden Costs”. On the one hand the cost of power in Poland is increasing leading to another problem for these companies. On the other hand, some of the companies are located in places where they must work using their own generators, which again generates and leads to further costs.

There are no challenges observed in the questionnaires specific for the business type.

Changes requiring a low level of investment	Changes requiring a high level of investment
<ul style="list-style-type: none"> – Providing relevant information in visible places on how to use transport more responsibly – Enabling the use/rental of environmentally friendly equipment: e.g. bicycles / scooters 	<ul style="list-style-type: none"> – Changing the main means of transport to those using organic/bio fuels

5. Conclusions

Despite having a high potential of contributing to their local community, it’s natural resources, it’s economic advancement, and sustainable development, Polish tourism SMEs may not only suffer from challenging

economic choices but also decisions that they have to make based on energy management trade-offs. When analysing inquiry responses it can be observed that there are all of the six barriers to energy efficiency occurring, and they are: risks, imperfect information, hidden costs,

access to capital, split incentives and fixed and bound rationality.

One can conclude that the most frequently mentioned challenges for Polish tourism SMEs were a lack of resources such as financial and human, lack of expertise and resources for proper energy management activities, lack of entrepreneur's awareness and interest in their sustainable practices, lack of in-house know-how and lack of established Polish guidelines on sustainable practices.

There are some innovations, developments and trends which will most likely influence the work of sustainability tourism businesses in 2019-2020.

One of them is the spreading, re-distribution of "over tourism" from the current most popular cities in South Baltic Region to the less popular smaller towns, rural areas and villages. This will impact the holiday experience of 99% of domestic and international tourists, which will become a major concern for many tourism managers on how to manage their hotels, spas and restaurants in a sustainable way in regard to technological and non-technological "soft" issues of running their businesses.

Sustainable tourism has awakened consumer's sense of responsibility in relation to being eco-friendly and conscious with the hope, that this will only grow and help drive behavioural change across a range of environmental issues. The role of technology and how it can assist in delivering effective tourism management solutions is also essential. Technology is a tool to be used and is not the answer in itself. However, we are already seeing the effective use of circular solutions to influence flows of visitors in and to some destinations. The opportunity to monitor the energy use in real time can ultimately assist capacity management and with open access to data this could help plan visitor flows and improve supply chain management.

The main conclusion is that the tourism sector in South Baltic Region is ready and well prepared and equipped on different levels for implementing the change from linear economy to circular economy in the context of energy. In the case of Poland the biggest challenge (that was mentioned in all of the receive questionnaires) is the lack of capital to implement circular economy solutions. It is worth to know that in Poland there are some challenges but at the same time and what is encouraging is that the people are beginning to see sustainable management, whatever the problems or solu-

tions, as a core living item and not something that can be ignored or pushed aside any longer.

Authors would like to mention that that the trend of research in circular economy regarding energy and level of implementing circular economy solutions (e.g. high efficient energy systems and sustainable energy management) is a new subject. Research described in this paper was the preliminary research which goal was to identify key problems in implementation circular economy solutions. Authors plan to perform research which will include more technical view of the problems as well analysis of the real example of implementing circular economy solutions.

Acknowledgements

This article was invited and accepted for publication in the EERA Joint Programme on Smart Cities' Special issue on *Tools, technologies and systems integration for the Smart and Sustainable Cities to come* [29]

This work was supported by the SuPREME project that has received funding from the European Union's Horizon 2020 research and innovation programme under Grant Agreement Number 692197

Project financed from financial resources for science in the years 2017-2018 granted for the implementation of an international co-financed project

The contents of this publication are the sole responsibility of the authors and can in no way be taken to reflect the views of the European Union, the Managing Authority or the Joint Secretariat of the Interreg South Baltic Programme 2014-2020.

References

- [1] Andersen MS. An introductory note on the environmental economics of the circular economy. *Sustain Sci* 2017;2:133–40. <http://doi.org/10.1007/s11625-006-0013-6>
- [2] Greyson J. An economic instrument for zero waste, economic growth and sustainability. *J Clean Prod* 2007;15:1382–90. <http://doi.org/10.1016/j.jclepro.2006.07.019>
- [3] Heshmati A. A Review of the Circular Economy and its Implementation. *Discuss Pap Ser* 2015;IZA DP No. <http://doi.org/10.1504/IJGE.2017.089856>
- [4] Su B, Heshmati A, Geng Y, Yu X. A review of the circular economy in China: Moving from rhetoric to implementation. *J Clean Prod* 2013;42:215–27. <http://doi.org/10.1016/j.jclepro.2012.11.020>

- [5] Setiartiti L, Hasibi RA Al. Low carbon-based energy strategy for transportation sector development. *Int J Sustain Energy Plan Manag* 2019;19:29–44. <http://doi.org/10.5278/ijsepm.2019.19.4>
- [6] Widzinski M. Simulation of an alternative energy system for district heating company in the light of changes in regulations of the emission of harmful substances into the atmosphere. *Int J Sustain Energy Plan Manag* 2019;24. <http://doi.org/10.5278/ijsepm.3354>
- [7] Romano S. Experimental demonstration of a smart homes network in Rome. *Int J Sustain Energy Plan Manag* 2019;24. <http://doi.org/10.5278/ijsepm.3335>
- [8] Cassinadri E, Gambarini E, Nocerino R, Scopelliti L. Sharing Cities: from vision to reality. A people, place and platform approach to implement Milan's Smart City strategy. *Int J Sustain Energy Plan Manag* 2019;24. <http://doi.org/10.5278/ijsepm.3336>
- [9] Tötzer T, Stollnberger R, Krebs R, Haas M. How can Urban Manufacturing contribute to a more sustainable energy system in cities? *Int J Sustain Energy Plan Manag* 2019;24. <http://doi.org/10.5278/ijsepm.3347>
- [10] Akinwale YO, Adepoju AO. Factors influencing willingness to adopt renewable energy technologies among micro and small enterprises in lagos state nigeria. *Int J Sustain Energy Plan Manag* 2019;19:69–82. <http://doi.org/10.5278/ijsepm.2019.19.7>
- [11] Ghisellini P, Cialani C, Ulgiati S. A review on circular economy: The expected transition to a balanced interplay of environmental and economic systems. *J Clean Prod* 2016;114:11–32. <http://doi.org/10.1016/j.jclepro.2015.09.007>
- [12] Murray A, Skene K, Haynes K. The Circular Economy: An Interdisciplinary Exploration of the Concept and Application in a Global Context. *J Bus Ethics* 2017;140:369–80. <http://doi.org/10.1007/s10551-015-2693-2>
- [13] Pearce DW, Turner RK. *Economics of Natural Resources and the Environment*. Baltimore: The John Hopkins University Press; 1990. <http://doi.org/10.2307/1242904>
- [14] Kirchherr J, Reike D, Hekkert M. Conceptualizing the circular economy: An analysis of 114 definitions. *Resour Conserv Recycl* 2017;127:221–32. <http://doi.org/10.1016/j.resconrec.2017.09.005>
- [15] Towards a circular economy: A zero waste programme for Europe. Brussels: 2014. [online]: <https://ec.europa.eu/environment/circular-economy/pdf/circular-economy-communication.pdf>
- [16] Towards the circular economy: Economic and business rationable for an accelerated transition. 2013. <https://www.ellenmacarthurfoundation.org/assets/downloads/publications/Ellen-MacArthur-Foundation-Towards-the-Circular-Economy-vol.1.pdf>
- [17] Hobson K. Closing the loop or squaring the circle? Locating generative spaces for the circular economy. *Prog Hum Geogr* 2015;40:88–104. <http://doi.org/10.1177/0309132514566342>
- [18] Annarelli A, Battistella C, Nonino F. Product service system: A conceptual framework from a systematic review. *J Clean Prod* 2016;139:1011–32. <http://doi.org/10.1016/j.jclepro.2016.08.061>
- [19] Tukker A. Product services for a resource-efficient and circular economy – a review. *J Clean Prod* 2015;97:76–91. <http://doi.org/10.1016/j.jclepro.2013.11.049>
- [20] United Nations Industrial Development Organization. Barriers to industrial energy efficiency: A literature review. Vienna: 2011. <http://doi.org/10.1108/IJESM-05-2013-0008>
- [21] Pieńkowski D, Kośmicki E. Funkcja produkcji gospodarki zamkniętego obiegu. *Ekon i Środowisko* 2016;2(57):10–22. [online]: http://www.ekonomiaisrodowisko.pl/uploads/ekonomiaisrodowisko57/01_pienkowski_kosmicki.pdf
- [22] Mapa drogowa transformacji w kierunku gospodarki o obiegu zamkniętym. Projekt Uchwały Rady Ministrów z dnia 12 stycznia 2018. 2018. [online]: <https://miir.bip.gov.pl/projekty-zarzaden-uchwal-i-obwieszczen/projekt-mapy-drogowej-transformacji-w-kierunku-goz.html>
- [23] Kulczycka J. Górnictwo i energetyka jako elementy gospodarki o obiegu zamkniętym. XXIV Międzynarodowa Konf. POPIOŁY Z Energ. - 2017, 2017. <http://unia-ups.pl/wp-content/uploads/2016/03/Kulczycka.pdf>
- [24] Picture: <https://www.eea.europa.eu/media/infographics/circular-economy/view> (accessed June 28, 2019).
- [25] Picture: <https://www.cpe.gov.pl/27,o-programie> (accessed June 28, 2019).
- [26] Manniche J, Broegaard R, Topso Larsen K, Holland E. Destination: A circular tourism economy. A handbook for transitioning toward a circular economy within the tourism and hospitality sectors in the South Baltic Region. 2017. https://circulareconomy.europa.eu/platform/sites/default/files/cirtoinno-handbook_eng-rev.-4.pdf.
- [27] Bassi F, Dias JG. The use of circular economy practices in SMEs across the EU. *Resour Conserv Recycl* 2019;146: 523–33. <https://doi.org/10.1016/j.resconrec.2019.03.019>.
- [28] Online article: <https://www.theguardian.com/us-news/2019/jun/25/climate-crisis-al-gore-global-economy-needs-major-upgrade-fast> (accessed June 28, 2019).
- [29] Østergaard PA, Maestosi PC. Tools, technologies and systems integration for the Smart and Sustainable Cities to come. *Int J Sustain Energy Plan Manag* 2019;24. <http://doi.org/10.5278/ijsepm.3450>



Sharing cities: from vision to reality. A People, place and platform approach to implement Milan's smart city strategy

Elisa Cassinadri^{a,*}, Elisa Gambarini^a, Roberto Nocerino^b and Lucia Scopelliti^a

^aMunicipality of Milan, Urban Economy and Employment Directorate, Via Dogana 4, 20123 Milan, Italy

^bPoliedra, Politecnico di Milano, Via G. Colombo 40, 20133 Milan, Italy

ABSTRACT

Transforming Milan into a smart city is a strategic objective and political priority of the Municipality, which has taken up a variety of projects and experiments with the aim to transform the main suburbs of the city into smart areas. This paper presents Milan's demonstration of a smart district supported by the European Union (EU) funded project *Sharing Cities*, aimed at creating a "smart" district with "near-zero" emissions in three different "lighthouse" cities, London, Lisbon, and Milan. The paper describes the first outcomes of this project in Milan, based on a *People, place and platform approach*, aimed at involving the different stakeholders and applying solutions to foster innovation processes instrumental to the implementation of a smart city urban agenda.

Keywords:

Smart district;
Strategy;
Pilot;
Engagement;
Scale-up;

URL: <http://doi.org/10.5278/ijsepm.3336>

1. Introduction

In the current global context, cities face common pressing challenges such as air pollution, climate change, and socio-economic sustainability associated to increasing urban population [1], and have often identified the journey into smartness as a privileged strategy to address such critical issues [2].

A variety of definitions of smart city abounds in academic, business and government debates [3]. On one hand, smartness is associated to pervasive and ubiquitous digital infrastructure; on the other hand, to social innovation and creativity enacted by smart people [4]. Currently, the concept of Smart city is increasingly linked to the presence of digital infrastructure, smart citizens and physical infrastructure enabling efficient, functional services [5].

In this context, over the recent years the Municipality of Milan has decided to promote the economic transformation necessary to tackle the pressing societal

challenges firstly by adopting a set of strategic policy frameworks on sustainable mobility, sustainable energy and smart agenda with a vision to become more sustainable, resilient, smart, and circular.

Specifically, the Sustainable Energy Action Plan (PAES), adopted by the Municipality in 2014, promotes several actions to achieve national and community targets for reducing greenhouses gas emission and support urban decarbonization [6]. Energy transition is encouraged through measures regarding energy efficiency of buildings, optimization of public lighting and conversion of the fossil system to a carbon neutral one by using renewable energy sources.

With the adoption of the Smart City Guidelines, the Municipality affirmed its overarching strategic objective and political priority to transform Milan into a smart city. After a consultation process, in 2014 the Municipality approved the document, based on a vision of smart city that does not only cultivate its technological component,

*Corresponding author - e-mail: Elisa.Cassinandri@comune.milano.it

Acknowledgement of value

The paper offers local stakeholders the opportunity to know Milan's demonstration of a smart district as it describes the first outcomes of the EU project Sharing Cities. The project allowed the Municipality to test a smart district pilot in the Porta Romana/Corvetto/Vettabbia area through deep retrofit interventions, to improve comfort and energy management of both private and public buildings, and the implementation of e-logistics, digital social market, smart-parking technologies and smart lampposts. I have closely followed the Sharing Cities project since its early stages as I retain that an eclectic action of knowledge and applications shared with the most involved stakeholders can give a substantial push towards the replication and scaling of the initiative. Citizens shall be aware of their pivotal role as enablers of this transformation from humble to more resilient, socially and environmentally sustainable cities.

Francesca Hugony
Researcher, ENEA - National Energy Agency, Italy

but must combine economic development and social cohesion, innovation, training, research and participation [7].

Since its adoption, Milan decided to test smart solutions coherent with its Smart City strategy focusing on limited parts of the city, for testing innovative solutions with the aim of scaling up to the rest of the city. At the national level, similar experimentations are being carried out, such as the Smart Home network experimentation in the Centocelle district of Rome [8].

In 2018 the City of Milan also approved the Sustainable Urban Mobility Plan (PUMS), aimed at meeting the

mobility needs of the population while ensuring the reduction of atmospheric and noise pollution levels and of energy consumption by enhancing public transport and shared mobility services [9].

This paper presents Milan's demonstration of a smart district supported by the EU funded H2020-SCC1 project *Sharing Cities* (www.sharingcities.eu), aimed at creating a "smart" district with "near-zero" emissions in three different "lighthouse" cities, London, Lisbon, and Milan (Figure 1), to respond to the main urban environmental challenges and improve the daily life of its inhabitants. In

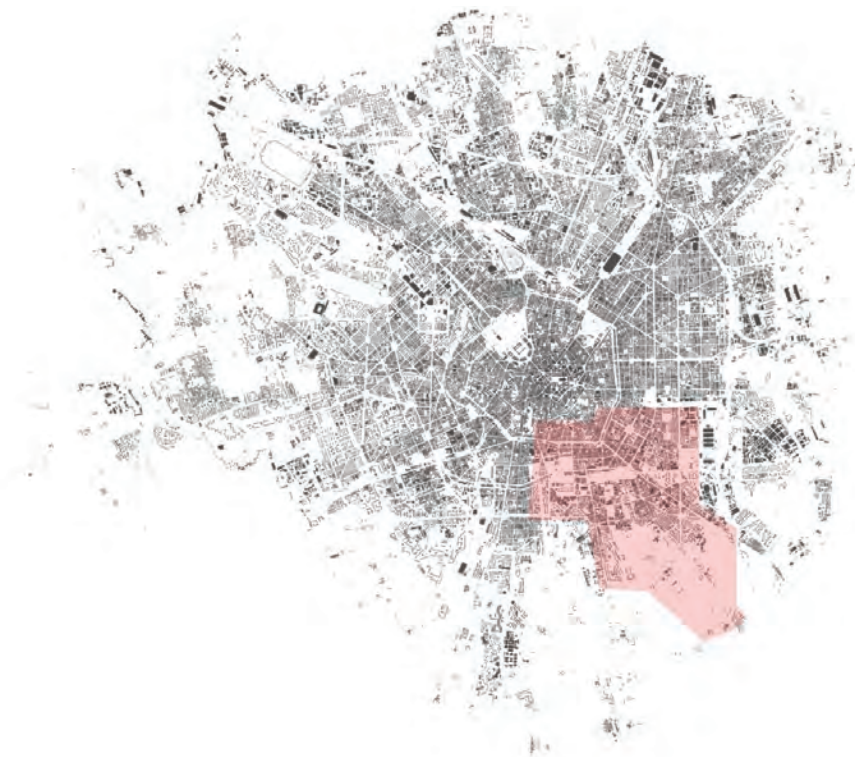

Figure 1: Map of Milan with Sharing Cities area

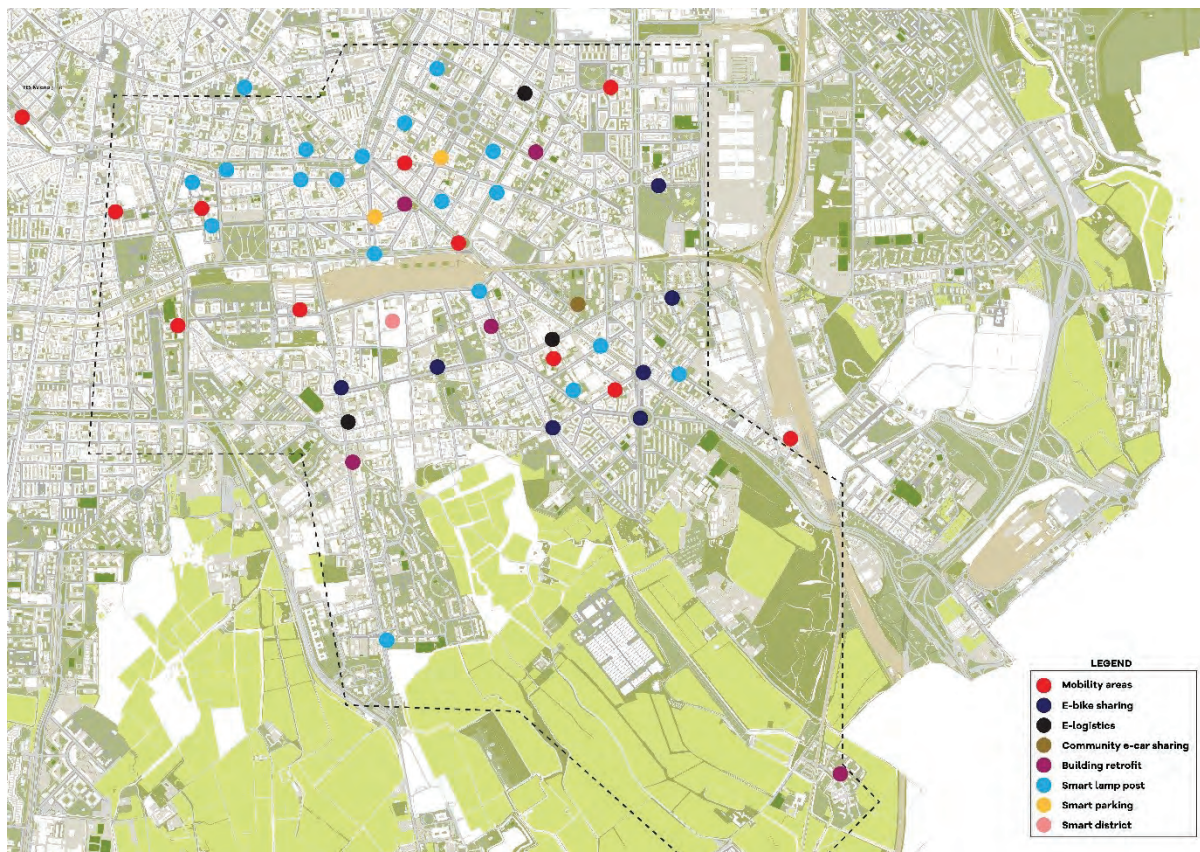

Figure 2: Map of Sharing Cities district

Milan, the project has allowed the Municipality to test a smart district pilot in the Porta Romana/Corvetto/Vettabbia district (Figure 2), based on its smart city strategies, with a view to scaling up and replicability.

This research is aimed at investigating the effectiveness of new technologies in improving urban mobility, increasing the energy efficiency of buildings and reducing carbon emissions along with the effectiveness of the *People, place and platform approach* to smart city. This paper presents the methodology adopted and the interventions carried out in the Sharing Cities project, followed by the preliminary results and conclusion.

2. Methodology

Sharing Cities adopted an original holistic “*People, place and platform approach*” taking account three dimensions: *people* (user-centric smart city services co-designed with citizens), *place* (infrastructure solutions for: low-energy districts, e-mobility, retrofitting of buildings, installation of sustainable energy management systems and smart lampposts) and *platform* (urban

sharing platform based on open data) as illustrated in Figure 3. The approach was developed by partners within the Sharing Cities project and applied to all the three partner cities.

The project is structured in six main pillars: 1) Deep Building Retrofit, 2) Shared e-Mobility (with five sub-domains: charging points, e-car sharing, e-bike sharing, e-logistics, and smart parking), 3) Smart Lampposts, 4) Sustainable Energy Management Service (SEMS), 5) Urban Sharing Platform (USP) and 6) Digital Social Market (DSM).

2.1. Sharing Cities: the six pillars

1) Deep Building Retrofit

The first pillar, which concerns the *place* dimension, is the deep retrofitting work for respectively 24,000 m² of private and 4,500 m² of public residential buildings, trying out an approach based on owners’ engagement through co-design processes, monitoring system, and deep retrofit interventions. The latter consisted in renewing the buildings by integrating them with low carbon energy sources (solar PV, water source heat pump) and energy



Figure 3: Sharing Cities three domains (people-place-platform) (www.sharingcities.eu)



Figure 4: Private residential building pre and post retrofitting funded by Sharing Cities

management systems which serve for monitoring and managing the energy consumption. Such interventions are aimed at an average 60% reduction in energy consumption and at an increased comfort inside dwellings.

Owners co-designed the retrofit interventions, as part of the co-design methodology defined by project partners in charge for citizens' engagement.

All of the five eligible private buildings, accounting for 262 flats and 24,000 m², have already undergone the process of retrofitting (Figure 4) as well as the

implementation of the monitoring system, which allows fuel and electricity consumption to be recorded every 15 minutes through smart meters, and temperature, humidity and CO₂ level to be analysed by wireless sensors. Data collected by smart meters is recorded by the utility company (A2A) and transferred to the Sustainable Energy System System (SEMS), while data gathered by other sensors is recorded through LoRaWAN technologies and directed to the Energy System. LoRaWAN is a Low Power, Wide Area networking protocol designed to wirelessly connect battery operated devices to the internet, targeting Internet of Things (IoT) requirements such as bi-directional communication, end-to-end security, mobility and localization services.

Since 95% of Italian public housing requires energy efficiency measures, the Municipality of Milan selected also one of its public residential buildings, accounting for 66 flats and 4,500 m², to test their feasibility. The deep retrofit process was focused on improving building occupants' indoor environmental quality through intervention specifications for energy retrofit and an innovative monitoring system. More specifically, the building was integrated with photovoltaic panels, solar thermal collectors, windows frames, mechanical ventilation and thermal insulation, along with an energy management system.

Energy efficiency measures included the arrangement of the thermal coating, through the application of the insulating material on the external facades of the

buildings, in order to reduce heat exchanges between inside and outside. The performance of the system chosen for the thermal insulation coatings allowed to reduce the thermal dispersions and therefore to contain the energy consumption. The operation will terminate with the replacement of the windows and the boiler with a centralized system. On the windows of the external facades, shading systems will be installed, so as to allow the control of natural light, improving the visual comfort inside the apartments and their isolation. Retrofit works on public building will be closed within the end of 2019.

2) Shared e-Mobility: creation of intermodality hubs

The shared e-mobility measure supports the shift from high to low carbon mobility, by implementing a number of shared e-Mobility “infrastructures and services”. These include: e-vehicles charge; e-car share; e-bikes; smart parking and e-logistics.

Specifically, e-vehicles charge was addressed by implementing 60 charging points in 10 Mobility Areas with the aim of fostering electric personal and shared mobility and intermodality. Mobility Areas for public e-car sharing offer free-floating car-sharing operators a parking and charging place and charging points for private users.

E-car share was promoted by installing 72 e-vehicles, two of which for building car sharing with 50 registered users. 10 e-cars for community car-sharing (Figure 5) were deployed in Symbiosis, a new

business district included in Sharing Cities area and ambition.

E-bikes service was promoted by providing 150 new e-bikes for bike sharing with child seats and 14 new stations (Figure 6) with the aim of supporting the shift from cars to active mobility. Furthermore, operator-based relocation systems were studied for ameliorating level of service.

Smart parking was addressed by providing 175 parking lots with smart parking sensors (for logistics, disabled people, no-parking areas), 100 of which are set to be installed in the 10 Mobility Areas to avoid illegal parking of private cars on lots dedicated to electric vehicles. The implementation of smart parking technologies, including the evaluation of sensor type implementation, tested and provided for operational experiences to incentivise e-mobility.

As part of the project, e-logistics measures were implemented in order to counter the increase in conventional (particularly diesel) freight delivery vans, spurred by the growth of on-line commerce. The electric logistics interventions aim to be the business cases for new ways of urban emission free logistics: 9 e-vans and two e-cargo-bikes (and 11 charging points) were set-up in the project area, guaranteeing zero-emission logistics for a mass-market retailer. These e-vehicles replaced 10 vans used by the company responsible for providing logistics home delivery services for Carrefour, a large-scale distribution company, with several shops in Sharing Cities area.



Figure 5: Building Car Sharing funded by the Sharing Cities project
Photo by Sara Soldano (www.sarasoldano.it)



Figure 6: E-bikes sharing station funded by the Sharing Cities project
Photo by Sara Soldano (www.sarasoldano.it)

3) Smart Lampposts: from Humble to LED to Smart Lampposts

The Smart Lampposts measure consisted in the installation of 28 sensors on 20 lampposts and the coverage of project area with LoRaWAN network. The 20 new Smart Lampposts are poles integrated with smart technologies, such as WiFi antennas, enabling environmental and traffic flows controlling. The smart approach consists in considering how to develop business models that incentivize the implementation of smart technologies (WiFi, air quality, parking, EV charging, etc.) alongside lighting, using the already existing assets: i.e. to boost the shift from “humble” lamppost to “smart lampposts”. The aim was to test added value services related to smart lighting, in order to demonstrate that the passage from humble to smart lampposts is feasible and convenient, so that other Institutions are encouraged to shift directly, skipping the LED lampposts step.

4) Sustainable Energy Management System

Sharing Cities envisaged the development of the Sustainable Energy Management System (SEMS), an advanced system for energy management and balance. The ambition of such tool is to provide for integrated, efficient, and interoperable energy management across urban infrastructures. More specifically, it optimises the relation between energy demand and supply, so as to reduce citizen's energy use and bills; within the e-mobility area, i.e. charging stations, it balances energy peaks so as to avoid network failures. Finally, such tool plays the role of data-bridge drawing data from the retrofitted buildings and making them available for the USP. The SEMS is a proprietary software

of Siemens, one of the project partners, and it will be used directly by the Municipality of Milan for monitoring and assessing the performances of retrofitted public social housing.

5) Urban Sharing Platform

With respect to the Platform domain, Sharing Cities envisages the creation of an Urban Sharing Platform (USP), an ICT platform able to gather data from several heterogeneous data sources and provide functions and services that help in enabling a smart city. Its aim is to aggregate data and control functions from a wide variety of devices and sensors (e.g. electric vehicles and bikes, smart lampposts and energy efficient buildings), store, process, correlate the data and present information to the city and citizens so as to enable a better use of the city resources. The project has allowed the implementation of a data monitoring service layer realized with the view to demonstrate the potential of interoperability and data integration processes. The USP, developed by the Informatics Service Directorate of the Municipality of Milan, will be one of the main asset for the City of Milan for data collection and integration, and further deployments will occur beyond Sharing Cities for enlarging included data set and enhancing the available tools. Though USP can be freely adopted by other Municipalities (as happened for the Municipality of Venice), each Lighthouse city works in the deployment of their USP in order to customize it according to their requirements.

6) Digital Social Market

Lastly, with respect to the people domain, the citizen-focused activities include the implementation of a Digital

Social Market (DSM), an ecosystem of relations between different actors that promotes citizens engagement and peer-to-peer exchange of good practices. The DSM in Milan has a community of users and rewarders, SharingMi, hosted by an app, greenApes, that rewards citizens’ positive behaviours. The application allows accessing a community of people who share ideas and concrete actions for a more sustainable lifestyle [11]. Virtuous behaviours are rewarded through prizes and discounts offered by the local businesses participating in the project. The Public Administration, that promotes the DSM, plays a role by setting challenges in particular sustainability fields (e.g. “Plastic free” challenge has encouraged users in sharing good practices in plastic saving).

3. Results

Ex-ante evaluation, performed for estimating the effectiveness of project actions, and preliminary collected data estimate that project actions have contributed to energy consumption reduction, CO₂ savings, increased data monitoring and collection and citizens’ engagement.

Building retrofit performances ex-ante evaluation is based on BEST table methodology, set up by European Commission, envisaging an energy diagnosis for estimating thermal energy consumption and a parametric estimation of electric energy consumption of the building. Energy needs, combined with dimensions of each intervention (such as façade insulation, mechanical ventilation, photovoltaic panels, etc.), technical characteristics and climate zone for each retrofit intervention allow the calculation of CO₂ and energy savings. Mobility performances ex-ante evaluation was set up by Sharing Cities technical partners through the design of cognitive map mode [12], able to identify causal networks to estimate the effects of each mobility measures implemented on the base of preliminary and parametric estimation of services use (such as travelled distances, energy performances, modal shift, etc.).

Since performances monitoring is at an early stage, only the modelled estimations and first data collected on mobility and energy are presented.

Energy efficiency measures on buildings are estimated to result in a 50–70% reduction of energy consumption compared to pre-implementation levels, improving also comfort inside dwellings. More specifically, available data show that the energy consumption has been lowered by 55% in one of the private residential building retrofitted and by 60% in the public residential building. The consumption of energy was halved in all of the retrofitted buildings and the CO₂ produced was lowered by 23,500 Kg. Retrofitting measures have also resulted in an increased comfort inside dwellings, by means of the stabilization of internal temperature at 24–25 C, and humidity level at 30%-70%, compared to a much greater pre-implementation temperature and humidity variance.

As argued in [10], available results suggest the participatory process proved crucial to the implementation of the deep retrofit interventions as it created consensus and increased the probability, speeding up the process of reaching the majority in the vote of the building assemblies, necessary to approve the interventions.

Sharing Cities acted in a consolidated urban area, optimizing, renovating, and putting in synergy different elements of an existing and living district in line with the Smart Retrofitted District approach, which consists of working on existing districts and is based on improving and renewing what is already in place. In such case, a top-down approach is not effective as residents need to be informed about the externalities of building retrofitting in terms of quality of life, economic benefits and the effects on the environment. Indeed, a fundamental aspect of this approach is the bottom-up, participative practices, aimed at building collaborative communities aware of the value of natural and social assets.

Shared mobility measures are expected to result in 646.21 tons CO₂ savings from the implementation time till the end of the project (Table 3). More specifically, e-car sharing contributes to save 202.37 tons of CO₂,

Table 1: Sharing Cities private buildings retrofitted

Name	Year of construction	Number of floors	Number of apartments	Total conditioned area (m ²)
Via Passeroni 6	1963	4/6	50	6260
Via Tito Livio 7	1960	7	25	2049
Via Verro 78 B/C	1979	5	36	3857
Via Fiamma 15/1	1967	7	15	3314
Via Benaco 26	1960	6	141	8830

Table 2: Comparison between energy consumption before and after deep retrofitting

[kWh/m ² y]	Initial Energy consumption	Post-retrofit energy consumption
Via Tito Livio, 7	143.2	58
Via Fiamma, 15/1	103.4	64.34
Via Verro, 78 B/C	91.5	37
Via Passeroni, 6	178	105.57
Via Benaco, 26	146.47	56.71

followed by e-logistics (28.80), e-Bike sharing (376.17) and eV charging stations (38.88).

Data monitoring system is being developed with the view to be instrumental to the development of new Municipal strategies. As the integration of data collected through the sensors into the Urban Sharing Platform is currently being finalised, while a survey is envisaged to assess the results, in terms of behavioural change, of the DSM, ex post evaluation and full critical discussion will be available only from 2020, after the completion of the monitoring & evaluation phase.

4. Conclusion

Sharing Cities has allowed the Municipality of Milan to test smart solutions coherent with its Smart City strategy focusing on a limited part of the city, with the aim of replicating and scaling up to the rest of the city.

Adopting a People, place and platform approach has allowed acting on the different dimensions of the concept of smartness and leveraging on each of them to maximize the policy effectiveness. A pivotal role is recognised to the citizen engagement, crucial to enable the behavioural change necessary to transform the cities into more resilient and socially and environmentally sustainable places.

Sharing Cities has allowed to apply smart city features in the city of Milan, which is committed to take forward the journey also intervening through other policies and projects. By an example, the EU funded EUGUGLE project focuses on buildings energy efficiency demonstrating the availability of building renovation models [12] that have near-zero energy consumption in view of large-scale deployment. The European H2020 project CLEVER (Cities Co-designing Locally tailored Ecological solutions for Value added, socially inclusivE

Table 3: Sharing Cities expected results of mobility measures

Mobility mode	Tons CO ₂
eV car sharing	202.37
eLogistics	28.80
eBike sharing	376.17
eV Charging stations	38.88
Total	646.21

Regeneration in Cities) contributes to defining the regeneration of urban spaces concentrating on the role nature-based solutions, i.e. solutions borrowed and supported by nature, that lead to environmental, social, cultural and economic benefits, thus contributing to achieving sustainability and energy and economic efficiency. Finally, the EU Horizon 2020 project Synchronicity allows a large-scale experimentation with IoT services within specific areas of the cities, in support of citizens to solve significant problems within three application domains: adaptive traffic management, multimodal transportation, community based policy making.

These are few examples of several put in place by Milan to address the current pressing urban challenges testing innovative solutions for creating a smart, sustainable, and resilient city. In particular, Sharing Cities has allowed the Municipality also to test the “human centred smart cities” approach, which emphasises the centrality of the citizens rather than that of technology, by leveraging on the methodological dimension of co-design processes and behavioural change.

Acknowledgement

This article was submitted and accepted for publication in the EERA Joint Programme on Smart Cities’ Special issue on *Tools, technologies and systems integration for the Smart and Sustainable Cities to come* [13].

The activities described in this paper received funding from the European Union’s Horizon 2020 research and innovation programme under grant agreement N. 691895 [14].

References

- [1] United Nations, Department of Economic and Social Affairs, Population Division, The World’s Cities in 2018—Data Booklet (ST/ESA/ SER.A/417),. https://www.un.org/en/events/citiesday/assets/pdf/the_worlds_cities_in_2018_data_booklet.pdf, 2018.

- [2] P. Newman, The environmental impact of cities, *Environment and Urbanization*, 18(2), pp.275–295. <http://doi.org/10.1177/0956247806069599>,2006.
- [3] V. Albino, U. Berardi and R. M. Dangelico, Smart Cities: Definitions, Dimensions, Performance, and Initiatives, *Journal of Urban Technology*, 22:1, 3-21, 2015 <https://doi.org/10.1080/10630732.2014.942092>
- [4] R. Kitchin, The real-time city? Big data and smart urbanism, *GeoJournal* (2014) 79:1–14, <http://doi.org/10.1007/s10708-013-9516-8>
- [5] A. Caragliu and P. Nijkamp, The impact of regional absorptive capacity on spatial knowledge spillovers: the Cohen and Levinthal model revisited, *Applied Economics*, 44:11, 1363–1374 <http://doi.org/10.1080/00036846.2010.539549>
- [6] Comune di Milano, Piano di Azione per l’Energia Sostenibile (PAES), <https://www.comune.milano.it/aree-tematiche/ambiente/energia/paes-piano-di-azione-per-l-energia-sostenibile>, 2014.
- [7] Comune di Milano, Linee guida Milano Smart City, <https://economielavoro.comune.milano.it/sites/default/files/2019-02/milano%20smart%20city%20-%20linee%20guida.pdf>,2014.
- [8] S. Romano, Experimental demonstration of a smart homes network in Rome, *Int J Sustain Energy Plan Manag* 2019;24. <http://doi.org/10.5278/ijsepm.3335>
- [9] Comune di Milano, Piano Urbano della Mobilità Sostenibile (PUMS), <https://www.comune.milano.it/aree-tematiche/mobilita/pianificazione-mobilita/piano-urbano-della-mobilita>,2018.
- [10] C. Meloni, F. Cappellaro, R. Chiarini and C. Snels, Energy sustainability and social empowerment: the case of Centocelle smart community co-creation, *Int J Sustain Energy Plan Manag* 2019;24. <http://doi.org/10.5278/ijsepm.3339>
- [11] SharingMI, <www.sharingmi.it>, 2019.
- [12] A. Luèa, A. Colornia and R. Nocerino, Cognitive mapping and multi-criteria analysis for decision aiding:an application to the design of an electric vehicle sharing service, *Transport Research Arena 2014*, Paris <https://pdfs.semanticscholar.org/0bc1/57ab7843b308f869614e984ea47c4af13c28.pdf>
- [13] Østergaard PA and Maestosi PC, Tools, technologies and systems integration for the Smart and Sustainable Cities to come. *Int J Sustain Energy Plan Manag* 2019;24. <http://doi.org/10.5278/ijsepm.3450>
- [14] Sharing Cities, “Building smart cities together - common solutions for shared challenges,” <www.sharingcities.eu>, 2019.

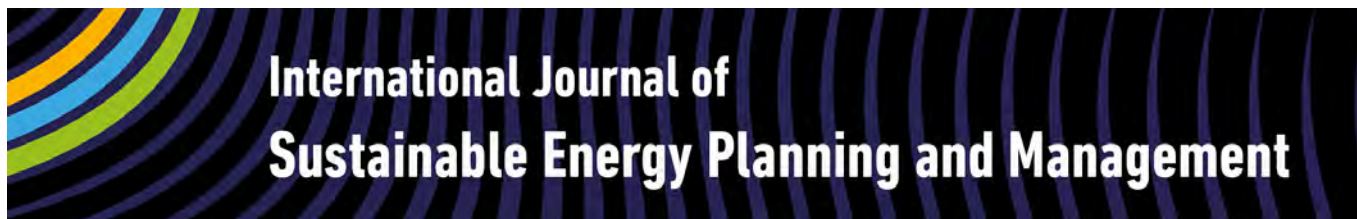

RESEARCH and EXPERIMENTATION

Solutions and services for smart sustainable districts: innovative Key Performance Indicators to support transition

Carola Clemente^{*a}, Paolo Civiero^b and Marilisa Cellurale^a

^aSapienza University of Rome, PDTA Department – Via Flaminia 72, 00196 Roma (IT)

^bIREC Catalonia Institute for Energy Research, Jardins de les Dones de Negre, 1, 08930 Sant Adrià de Besòs, Barcelona (Spain)

ABSTRACT

The European Strategic Energy Technology Plan (SET Plan) supports the Energy Union's policies by setting the strategies for the European Union energy sector. In 2018, the Implementation Plan traced the pathway in planning, deployment and replication of 100 Positive Energy Districts (PED) by 2025. This article presents innovative research on models, methodologies planning tools and technology solutions for the short-medium term implementation of PEDs.

The approach and methodology behind the research is based on an operational framework set up to identify gaps and sharing for urban services' implementation and to support life improvements for citizens, consumers, and prosumers.

The main output of this research report is a framework to facilitate a synthetic evaluation of the positioning and improvement of each smart city solution considered in the study. These are referring to engagement phase (planning, design, construction, management) and engagement scale (functional unit, building, blocks of building, infrastructures, environment). Furthermore, the framework improves the identification of strategies and stakeholders' commitment to promote Smart Urban District or PEDs transition.

This research contribution stems from the project *SCC solutions for Positive Energy Districts – Research of Electric System/Annual Implementation Plan 2018/41* between Sapienza University of Rome and ENEA Energy Technology Dept. – Sustainable Energy Network. The broader aim of that project has been to design a set of strategies to facilitate the transition of the built environment towards e.g. Smart Energy Districts.

Keywords:

Positive Energy Districts;
Transitions and Dilemmas;
Key Performance Indicators;
Smart Cities and Communities solutions

URL: <http://doi.org/10.5278/ijsepm.3350>

1. Introduction

In in the context of a decade of deep economic suffering, the transition from the EU Horizon 2020 to the EU Horizon Europe programme marks an important landmark in analysis and evaluation about the climate and energy policies. The energy issue, no longer confined to the resource-consumption binomial, has been recognized by the international scientific community [1–5] as a pervasive issue, linked to the economy of scale, information,

interoperability of systems, and the quality of citizens' behaviour. Over the last ten years, the European Energy Research Alliance (EERA) through the Joint Programme Initiatives (JPI) has provided the scientific and operational basis to realise the full potential of energy efficiency in urban areas [6].

The rapid technological advancement, especially in the big data management and IoT field, supported the commitment of the JPI Urban Europe in getting ahead

*Corresponding author - e-mail: marilisa.cellurale@uniroma1.it

Acknowledgement of value

The added value of the research “SCC solutions for positive Energy District – RdS/PAR2018/041” is the setting up of a framework which support synthetic evaluation and facilitate public officers within a Municipality to recognize which alternatives would support the transition to PEDs according to Italian rules and regulation. The idea is that this framework could facilitate their deployment and replication to each local context as for instance, Taranto.

I believe that PEDs must be not only efficient from the energetic point of view, but also they must integrate functional, technological and social aspects, with an overall improvement of services for citizens to support transition towards urban sustainability.

That is why the main outputs and results of the research project could facilitate Municipal Council Representatives in the comprehension and laying out of strategies which can be effective to enable urban regeneration. This is the main objective for Taranto City where it is necessary to develop an integrative approach which includes technological, spatial, regulatory, financial, environmental, social and economic perspective driven by City in cooperation with industry and investors, research and citizen organization.

Ubaldo Occhinegro, Council Representative for Urban Planning - Construction, Mobility and Strategic Plans, Municipality of Taranto, Italy

“a purely techno-centric vision that reduced smartness to a driver for the economic development of those companies that in various way operate in the ICT” [7].

In 2018, the Implementation Plan traced the pathway in planning, deployment and replication of 100 Positive Energy Districts (PEDs) by 2025, defined as follows: *“PEDs require interaction and integration between buildings, the users and the regional energy, mobility and ICT systems, as well as an integrative approach including technology, spatial, regulatory, financial legal, social and economic perspectives. Ideally, PEDs will be developed in an open innovation framework, driven by cities in cooperation with industry and investors, research and citizen organisations” [8].*

The research project “SCC solutions for positive Energy District — Research of Electric System (RdS)/ Annual Implementation Plan (PAR) 2018/41” - a collaboration between Sapienza University of Rome PDTA and ENEA Energy Technology Department Sustainable Energy Network - moves from vision and understanding highlighted in the SET Plan Implementation Plan Action 3.2 Smart Cities, which aims to support the planning, deployment and replication of 100 Positive Energy District by 2025 for a sustainable urbanization.

The research project aims to create a support to facilitate cities towards a positive energy transition identifying properties of PED, priorities for planning/deployment of PED and an innovative Key Performance Indicators (KPIs) system to promote transition.

The main outcomes could be based on:

- PED conceptual framing as a transition from Smart Urban District model highlighting gaps and commonalities;
- PED conceptual framing according to “new” urban dilemmas able to highlight which Smart Cities and Communities (SCC) solutions better allow the transition towards PED;
- an innovative framework and KPIs system for identifying SCC solutions enabling transition towards PED.

The research project is therefore focused on the systematization (a) of the main implementation domains for PED transition, (b) the products and solutions according to the different dilemmas in PED, (c) the scales and phases, and (d) the relevant stakeholders for planning and deployment of PED supporting development of a set of SCC solutions.

The final result is a framework and an innovative KPI evaluation system to identify for each SCC solution (technologies, sensors, products, apps, ICT, etc.) the level of technology readiness level (TRL), the stakeholder type which is necessary to involve to support planning and deployment of SCC solutions as well as the engagement phase (planning, design, construction and management) and the engagement scale (functional unit, building, blocks of building, infrastructure, environment). The framework allows to identify gaps and commonalities for implementing urban services which

support a high quality of life for the consumers/prosumers.

An added value of the research project is an innovative way to create a repertoire of technological solutions, which includes a defined quantity of devices, products and tools within a wide range of solutions available on the market and/or ready for the test-bed phase as well as a KPI metrics to identify engagement scale and engagement phase as well as the potential stakeholders to involve in.

2. Smart Urban District priorities and dilemmas facilitating PED transition.

This research project follows the previous one, namely “RdS/PAR2017/075” which aim was underline the technological solutions already available on the market to support the transition towards Smart Urban District and highlighted that it is necessary to integrate the regulated model of city transformation - for discrete stadiums and sectors as prescribed by the regulatory framework[†]- with an holistic approach to stimulate the optimization of resources through the application of SCC solutions, thus promoting a high interoperability degree. The reasoning refinement and the tools developed within the Smart Urban District, both on a technical and epistemological level, require a continuous evaluation, revision and implementation of the adopted solutions.

[†] We are referring to the European and national regulatory framework for energy, which has the strength of defining a minimum level of energy performance of built environment but does not promote an integrated vision regarding the optimization of energy systems

It is therefore a question of constructing a scalable methodological and operational framework, aimed at responding to two orders of preliminary considerations, referred to the national level (Italian case study):

1. the structural characteristics of Italian urban realities [9] qualify the dilemmas with respect to the consistency of the built heritage and to the dimensional and evolutionary parameter of the urban application field;
2. to correspond, where useful, to the objectives of SET - Plan on Action 3.2, it is necessary to set up the instrumental framework for implementing and governing the transition to PEDs for progressive steps of immediate implementation.

According to this, a logical (computer) tool has been designed for the recognition and systematization of the SCC resources and solutions already operational and implementable within the Smart Urban District.

In the next step, there are two conceptual evolutions able to orientate the transition to the PED.

The first concerns the measurement of the effectiveness of the solutions identified: we intend to measure the smart quality not only with reference to the objective performance indicators but based on the field of application, then interoperability with other solutions, at different scales; the second concerns degree of gain that the combination itself generates, referred to the sum of the KPIs of the individual instruments. In other words, measuring quality on applications means evaluating the effectiveness of an interoperable system, such as the ratio between the sum of the expected (project) performance of a solution and the plus value (positive KPI)

Table 1: Analysis Model for implementation of the SCC solutions in areas of Urban Dilemmas

Areas	Key Tools/ Technologies		Engagement phase	Engagement scale	Stakeholder
	answer in areas	Implementation domains			
1. Safety & Security,	Ref. to all Areas (1,2,3, ...)	1. Technologies in built environment	1. Planning,	1. Functional unit,	1. Government,
2. Health,		2. Energy supply system,	2. Design,	2. Building,	2. R&I,
3. Education,		3. Water disposal system,	3. Construction,	3. Block of buildings,	3. Financial/Funding,
4. Mobility,		4. Waste disposal system,	4. Management.	4. Infrastructures (material/immaterial),	4. Analyst, IT project and Big Data,
5. Energy,		5. Mobility system,		5. Environment (physical/social).	5. BPM,
6. Water,		6. Public space,			6. Urban Services,
7. Waste,		7. Regulatory framework.			7. Real Estate,
8. Economic development, Housing and Community.					8. Design/ Construction,
				9. Social/Civil Society,	
				10. eCommerce.	

Table 2: SCC Solutions areas of Urban Dilemmas. Implementation of solutions/services according to [11,12]

Key tools/technologies answer in areas		
Areas	Class of solutions	Solutions
1 Safety & Security		real time crime mapping smart surveillance body worn cameras disaster early warning systems predictive policing emergency response optimization crowd management building security and safety system personal alert applications gunshot detection data driven building inspections
2 Health		telemedicine online care search and scheduling real time air quality information infectious disease surveillance lifestyles wearables remote monitoring applications and medication adherence tools data based population health interventions first aid alerts integrated patient flow management system
3 Education		e-learning platform augmented reality tools building automation simulator Education&Training platforms energy management awareness real time behavioral impact personalized education applications open data/data management platform
4 Mobility	sharing/ e-hailing/ autonomous driving	private e-hailing bike sharing car sharing autonomous vehicle pooled e-hailing demand-based micro transit traffic management and data services real time road navigation
	traffic management and data sharing	real time road navigation integrated multimodal info digital payment in public transit intelligent traffic signals and vehicle preemption real time public transit info smart parking predictive maintenance of transit infrastructure congestion pricing
	urban cargo	smart parcel lockers parcel load pooling and urban consolidation centers

Table 2: SCC Solutions areas of Urban Dilemmas. Implementation of solutions/services according to [11,12]

Key tools/technologies answer in areas		
Areas	Class of solutions	Solutions
5 Energy		distribution automation system dynamic electricity pricing building energy consumption tracking smart streetlights building automation systems building energy automation systems
6 Water		leakage detection and control water consumption tracking water quality monitoring smart irrigation
7 Waste		waste collection route optimization digital tracking and payment for waste disposal
8 Economic Development Housing and Community		local connection platforms peer to peer accommodation platforms digital administrative citizen services local civic engagement application local e-career center online retraining programmes

generated by an optimized combination of solutions different, in response to urban dilemmas[‡], as it will be explained later in this article.

3. Transition towards Positive Energy Districts: dilemmas and solutions

The transition to an energy surplus goes through the domains already identified for the Smart Urban District, which are specified in urban dilemmas to which SCC technologies and solutions respond. The table below shows the correspondences between the urban domains involved in the transformation, identified by the World Economic Forum [10] and the eight transition contexts, identified as areas for defining “dilemmas” [11].

In the operative matrix the dilemmas categorize the relative answers in terms of technologies.

In accordance with the ontology drawn by the SET Plan ACTION 3.2, the solutions to the dilemmas are implementable and not unambiguous. A first survey

conducted by McKinsey & Company [12] was adopted as a coherent trace to the previously stated objectives, susceptible of subsequent implementations dictated by the expression of future urban dilemmas and consequent technical responses of research and innovation.

Key Tools & Technologies become the enabling factors that, conveniently combined with business models and system stakeholders, allow the development of SCC solutions which facilitate transition towards PED [8].

4. Implementation domain

Taking into account the formulation of the SET Plan ACTION 3.2 Implementation Plan, the Positive Energy District should involve the optimization of three dimensions:

- Energy efficiency in buildings;
- Energy flexibility within the districts;
- Supply, at the regional or local level, of energy from renewable sources.

The actions have an impact on urban physiology, recognized in six classes of physical components and one of a disciplinary nature (Table 3).

Furthermore, the listed classes constitute domains of systems and relationships in which the dilemmas originate. The effectiveness of the combined and integrated application of SCC solutions is linked to the ability to

[‡] The contents of the document, therefore, adhere to the purposes of Module 4 - Replication and Mainstreaming of PED, specifically the “Activity No 4 - Identify analyze policies mixes and initiatives for PED transition, and enable to transfer from research into practice, as well as co-creation with industry and city partners” programmed in the implementation of SET-Plan ACTION.

Table 3: Implementation domains of the SCC solutions
Implementation domains of key tools/technologies answer in areas

Technologies in Built Environment	Energy Supply System	Water Disposal System	Waste Disposal System	Mobility System	Public Space	Regulatory Framework
Building						
Infrastructures						
Material Infrastructures						
Immaterial Infrastructures						

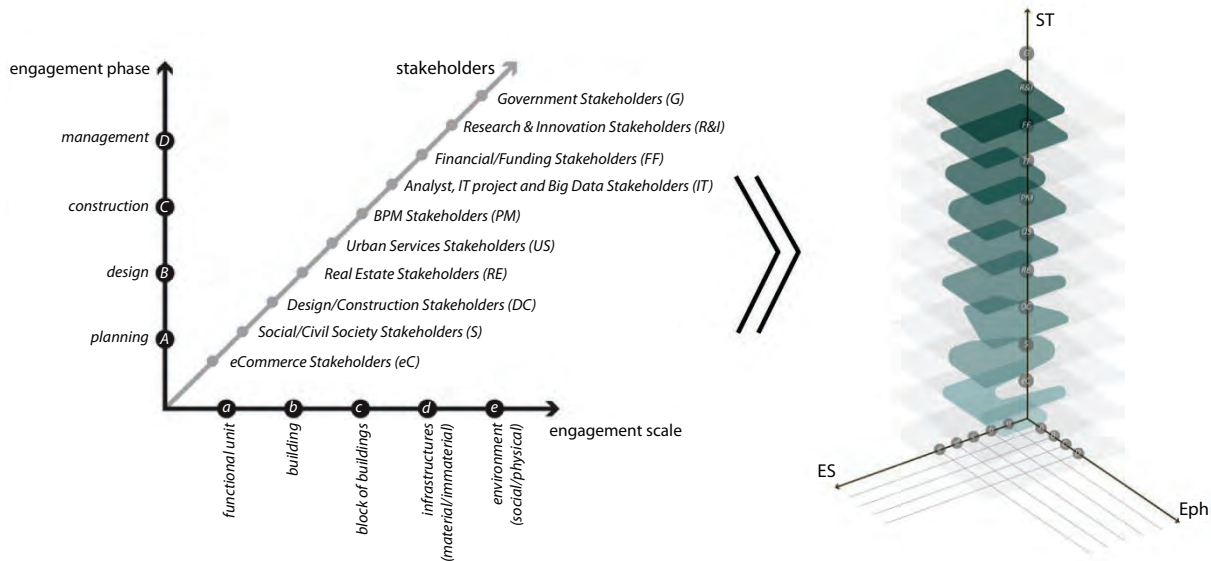

Figure 1: On the left side, the dimensions of the transformation and implementation of the SCC solutions: engagement phase/scale with stakeholders. On the right, Logical framework applied to the “motion sensor” technology for the evaluation of its effectiveness and potential

recognize the connections between domains, the subjects involved in proposing and discussing dilemmas and designing, therefore, the implementation of systems and components. The synoptic framework qualifies as a tool for the positioning of existing ICT products, for the identification of gaps, for the possible development of unpublished fields of application or for the enhancement of existing solutions. In fact, it is believed that the first transition to PEDs is knowledge and organization of existing resources, a sort of accelerator and generator of plus-valence on what we already have in our hands.

5. Transitions towards PED: step towards and engagement

As already mentioned, we consider the physical dimension of urban reality as an indispensable factor in the evaluation of solutions and potential value generation.

For this reason, a further coordination effort is required for positioning different solutions within the matrix.

The left side of Figure 1 shows the dimensions of the transformation in terms of time as phases - that characterize the transformation processes of the built environment - and dimension of the action triggered by the solution or the integrated solution system in the relative implementation domain, from the functional unit, in which the individual prosumer acts, to the environmental dimension, as the sphere of physical and social relations, to which the highest degree of complexity is attributed. The third dimension, the system stakeholders, links the effectiveness of the tools themselves to the ability of the actors of the supply chain to play the role of accelerators (RdS / PAR2016 / 033) of the implementation of SCC solutions and to express the potentials of use unpublished.

On the right side, Figure 1 shows, through a three-dimensional representation, the functioning of the

logical framework applied to the “motion sensor” technology, described in detail below.

The impact of the adoption of the motion sensor is not assessed in itself but with respect to its ability to affect the different scales of the urban environment and to involve stakeholders in the interaction with technology.

Thanks to the given framework, the ability of the stakeholders to activate and promote the implementation in the two engagement dimensions (phase and scale) is able to shape differently the specific weight of the SCC solution. It appears clear that overlap and consolidation of stakeholder interests accelerate and amplify the effectiveness of the process.

6. Analysis of SSC solutions and specific implementations towards energy services to support PED.

Market demand analysis as well as experimentation of innovative products/ solutions in the RD&I areas (i.e.: ICT., robotics and industrial automation) could highlight possible ingenious scenarios in the perspective of the Smart City to come. In this perspective, PEDs are an integral part of this process, in line with the SET-Plan ACTION n.3.2, in line with the strategies of sustainability and energy efficiency in the environment built at different scales (from the building to the district, to urban space), according to synergistic actions defined among the Member States of the European Union.

Among the solutions deriving for RD&I actions, integrated solutions are potentially the most useful for the diffusion of PEDs, thanks to the interoperability that is established between technologies, infrastructural networks and systems as well as the improved ability to manage a large amount of data [13-16]: the dialogue among systems, technologies and components allows the transition from single architectures to an ecosystem which enable new services that interact each other in a collaborative approach, favoring the automatic interaction between applications and their reuse.

Thanks to interoperability it is possible to share and use information promptly, and thus overcome the traditional subdivision into vertical silos to achieve communication between horizontal silos. The classification of solutions according to certain areas of interest is therefore useful for defining the field of action of each individual solution and the level of technological innovation achieved, in order to promote an adequate integration between energy and urban services through the inclusion

of additional services (not only energy services) useful to promote a higher level of quality of life for the citizen, consumer and prosumers.

By processing the data, it is therefore possible to implement software applications capable of carrying out specific functions and activating potential services aimed at certain user categories, according to specific thresholds set by the system. The communication of data and information is made possible to the end user and accessible to service providers, through the use of mobile devices (SD - Smart Devices – e.g. smartphones, tablets and other dedicated systems): this process of transmission of information and communication with end users and stakeholders makes it possible to create new management tools for buildings and the city and to define new scenarios for the use of the built environment condition.

According to the given premises it is possible to distinguish: devices and products, communication interfaces, energy management platforms and urban planning, web tools and interactive apps, whose purpose - as mentioned - is on the one hand improving the performance of the built system and, on the other, to raise the quality of life of the person, enabling a range of innovative services to the citizen, according to specific areas of action and intervention.

Thanks to the research it has been possible to create an analysis tool for the identification of potential products which need to be implemented for PED transition, according to the Italian situation and with respect to certain domains of interest, defining priorities and level of TRL.

Through the systematization of information, it is therefore possible to identify areas, products, stakeholders and the relative level of TRL maturity achieved by each solution, in order to verify the effective implementation and applicability to the national context.

The research activity was therefore aimed at identifying the specific functions of the products and the type of service that they are able to provide, with reference to the scope of the main “dilemmas” previously defined (Economic development housing and community; Health, Mobility, Safety & Security, Waste, Water) as determined in SET-Plan ACTION n.3.2 and in the framework of the respective “domains” of the implementation, in order to recognize gaps to solve in the future, according specific areas and lines of action .

The following type of solutions has been defined (A - Actuator, B - Bus connectivity, G - Gateway,

SD - Smart Device, SM - Smart Meter, SO - Smart Object, SS - Smart Sensor (in the case of technologies and devices); IC - Communication Interfaces, IP - Interactive Platforms (apps), UP - Urban energy management platforms) as well as functioning and performance (i.e.: systems activation, communication with the end user and system stakeholders, control, monitoring, collection and transmission of info or services).

The specific functionalities, the quantity and quality of the parameters that the individual solutions are able to manage or the type of service they are able to supply in an integrated way have also been determined - AAL - Assisted Living, COM - Comfort, NRG - Energy, SAE - Safety & Security. While Assisted Living's solutions (AAL - Ambient Assisted Living) are mainly aimed at fragile user categories - such as disabled or elderly people - the other devices refer to generic users, is able to offer diversified services, such as control of the environmental conditions to guarantee the wellbeing of the occupants (COM - Comfort), or adequate safety conditions (SAE - Safety & Security) to ensure the safety of the users with respect to external agents or the occurrence of dangerous situations for the person, the management of energy consumption (NRG - Energy) aimed to reduce polluting emissions and the consequent economic savings.

It is indeed possible that the same device is able to enable multiple services and can be effective for different and multiple levels of user satisfaction, embracing distinct features or parameters.

In order to verify solutions interoperability, the communication protocol (e.g. wireless or wired) to which the individual solutions refer has been identified as well as location in the physical space (i.e. indoor or outdoor) according to the radius of action that they are able to intercept.

The table presented in this article are part of a selected repertoire of technological solutions, in which a defined quantity of devices, products and tools is included within a wide range of solutions available on the market and/or being tested.

The repertoire of solutions is a sort of catalogue, potentially useful in the project's elaboration phases which could be used as a device for sharing knowledge on these systems. These solutions, despite being widely used in many international contexts, do not yet enjoy regulatory, performance and appropriate use, such as its immediate application on a national scale. The radial graph allows to determine the level of technological progress achieved according to the TRL levels defined.

Thanks to the Figures 2 and 3 it possible to identify gaps and missing solutions for the provision of specific services and with a view to achieving higher levels of quality of life for the citizen, consumer/prosumers, within the framework of the "dilemmas" previously established.

7. Conclusion

This paper highlights strengths and weaknesses for the transition towards PED through the "dilemmas" approach.

According to the actual state of art in SCC solutions, it has been possible to identify the area which the single solution/product is able to support, as well as priorities and research perspectives.

The consequent framework which derives is a tool to guide, verify and assess the TRL level (achieved / objective / priority) for each single technology or group of technologies, devices, products, apps and integrated intelligent systems. It is also possible to implement areas for R&DI on solutions able to provide urban services to support PED transition. The given flexible model is effective to recognize functionality and criticism for each solution, and to position research and products in the market as well as stakeholders related to the specific solution.

The table for product/solution illustrated in the article represents a small selection of a wider repertoire, which includes a defined quantity of devices, products and tools within a wide range of solutions available on the market and/or being tested.

The repertoire of solutions is a sort of catalogue, potentially useful in the definition phases of SCC solutions. The information and the radial chart that accompanies each data sheet make it possible to determine the incidence and level of integration for each solution having in mind the 4 dilemmas and the specific areas for urban dilemmas, as well as the technological progress achieved according to the TRL levels.

This representation also makes it possible to identify any gaps and missing solutions for the provision of specific services and with a view to achieving higher levels of quality of life for the citizen / user, within the framework of the "dilemmas" previously established.

Acknowledgement

This article was invited and accepted for publication in the EERA Joint Programme on Smart Cities' Special



Technical features

Ultralight, compact, battery powered. Completely wireless.

Wall mounting h min 2,40 mt / other
 Measurement range lux: 0 - 32000 lux
 Measurement range °C: -20 - 100 °C
 Operating temperature °C: 0-40 °C
 Frequencies: 868.4 or 869.08 MHz (EU)
 Distances: up to 50 m (outdoor)
 Distances: up to 30 m (indoor)
 Dimensions: 46 mm

Dilemmas

- Digital transition in urban context
- From urban resilience to urban robustness
- Sustainable land-use and urban infrastructures
- Inclusive public spaces for urban liveability

Areas



Keytools answer in Areas

- **Economic development housing & community**
 - digital administrative citizen services
 - local civic engagement application
 - local connection platforms
 - local e-carer center
 - online retraining programmes
 - peer to peer accomodation platforms
 - personalized education
- **Education**
 - augmented reality tools
 - building automation simulator
 - education & training platforms
 - e-learning platform
 - energy management awareness
 - open data / data sharing
 - personalized education
 - real time behavioral impact
- **Energy**
 - building automation system
 - building energy automation system
 - building energy consumption tracking
 - distribution automation system
 - dynamic electricity pricing
 - home energy automation systems
 - home energy consumption tracking
 - smart streetlights
- **Health**
 - medication adherence tools
 - online care search and scheduling
 - real time air quality information
 - remote monitoring applications
 - telemedicine
- **Mobility**
 - autonomous vehicle
 - bike sharing
 - car sharing
 - congestion pricing
 - demand-based microtransit
 - digital payment in public transit
 - integrated multimodal info
 - intelligent traffic signals and vehicle preemption
 - parcel load pooling & urban consolidation centres
 - pooled e-hailing
 - predictive maintenance of transit infrastructure
 - private e-healing
 - real time public transit info
 - real time road navigation
 - smart parcel lockers
 - smart parking
 - traffic management and data services
- **Safety and Security**
 - body worn cameras
 - building safety & security system
 - crowd management
 - data driven building inspections
 - disaster early warning systems
 - emergency response optimization
 - gunshot detection
 - home security and safety system
 - personal alert applications
 - predictive policing
 - real time crime mapping
 - smart surveillance
- **Waste**
 - digital tracking and payment for waste disposal
 - waste collection route optimization
- **Water**
 - leakage detection and control
 - smart irrigation
 - water consumption tracking
 - water quality monitoring

Description

The "motion sensor" is a multifunctional smart sensor, as it is able to perform multiple functions within the same technology. The motion sensor is, in fact, at the same time able to measure the temperature and intensity of the light present in the home environment, offering a range of additional performances thanks to its ability to detect movements and changes in the position of objects, people and animals. The motion sensor is a battery-powered device designed to be easily installed on any surface. The LED indicator signs movement, temperature level, operating mode and can be used to check if the device is inside the Z-Wave network. A lux sensor allows you to dynamically adjust artificial lighting in relation to the intensity of natural light present outside. The motion sensor is also able to adjust the light intensity according to the presence of people in the environment and adapting it to the specific user preferences, activating predefined scenarios based on the time of day and the position of the sensor inside or outside the building. The sensor is also able to intelligently recognize people and animals, useful for the purposes of intrusion safety and can be configured to detect any vibrations in the event of an earthquake, by setting certain parameters.

Typology

- A - actuator
- B - bus connectivity
- G - gateway
- IC - communication interface
- IP - Interactive platform (app)
- SD - smart device
- SM - smart meter
- SO - smart object
- SS - smart sensor

Function

- activation
- communication with end-user
- control
- data collection
- monitoring
- transmission of informations

Service

- AAL - Assisted Living
- COM - Comfort
- NRG - Energy
- SAE - Safety & Security

Position

- indoor
- outdoor

Functionalities and parameters

- accelerometer (earthquake)
- activity
- air velocity (wind)
- artificial light
- breath command
- CO2 concentration, VCO
- consumptions (water, gas, electricity)
- emergency (building system)
- emergency (user)
- falls
- fire presence
- gas & smokes presence
- humidity
- incontinence
- movement (users and animals)
- natural light
- night light paths
- open / close
- presence (users and animals)
- rain
- rumor / sound
- sleeping quality
- temperature
- vital parameters
- vocal command
- water leak presence

Requirements

- environmental**
 - Artificial lighting monitoring
 - Indoor air temperature monitoring
 - Natural lighting monitoring
 - Motion and external agents presence control
 - Earthquake monitoring and dynamic actions
- technological**
 - Emergency operation

Protocol

- wired
- wireless

Producer

Fibaro

Figure 2: Motion Sensor datasheet



App informations

Research project: Your Wellness
Country: Dundalk, Ireland
Year: 2013 - in progress

R&D: Netwell Centre, CASALA
U: Dundalk Institute of Technology
SME: Fujitsu
Others: Dundalk Town Council, Department of Environment and Local Government, Atlantic Philanthropies, Sustainable Energy Authority of Ireland

Dilemmas

- Digital transition in urban context
- From urban resilience to urban robustness
- Sustainable land-use and urban infrastructures

Inclusive public spaces for urban liveability

Areas



Keytools answer in Areas

Economic development housing & community

- digital administrative citizen services
- local civic engagement application
- local connection platforms
- local e-carer center
- online retraining programmes
- peer to peer accommodation platforms
- personalized education

Education

- augmented reality tools
- building automation simulator
- education & training platforms
- e-learning platform
- energy management awareness
- open data / data sharing
- personalized education
- real time behavioral impact

Energy

- building automation system
- building energy automation system
- building energy consumption tracking
- distribution automation system
- dynamic electricity pricing
- home energy automation systems
- home energy consumption tracking
- smart streetlights

Health

- medication adherence tools
- online care search and scheduling
- real time air quality information
- remote monitoring applications
- telemedicine

Mobility

- autonomous vehicle
- bike sharing
- car sharing
- congestion pricing
- demand-based microtransit
- digital payment in public transit
- integrated multimodal info
- intelligent traffic signals and vehicle preemption
- parcel load pooling & urban consolidation centres
- pooled e-hailing
- predictive maintenance of transit infrastructure
- private e-healing
- real time public transit info
- real time road navigation
- smart parcel lockers
- smart parking
- traffic management and data services

Safety and Security

- body worn cameras
- building safety & security system
- crowd management
- data driven building inspections
- disaster early warning systems
- emergency response optimization
- gunshot detection
- home security and safety system
- personal alert applications
- predictive policing
- real time crime mapping
- smart surveillance

Waste

- digital tracking and payment for waste disposal
- waste collection route optimization

Water

- leakage detection and control
- smart irrigation
- water consumption tracking
- water quality monitoring

Description

Your Wellness is defined as a smartphone or iPad app, used to detect a series of physiological and behavioral conditions of users, thanks to the possibility of receiving feedback on their wellbeing or health conditions, activating preventive actions. The first phase of the research allowed at the definition of some wellness categories to be monitored through the platform, which mainly concerned the quality of sleep, mood and social interaction. Data from sensors integrated into the building system are useful to obtain additional information such as the history of falls, the feeling of fear due to the insecurity in the environment and the level of user activity as fatigue or cognitive performances. The use of data from motion sensors take informations about the activities daily living and the detection of user's position inside or outside the apartment or building. A localization map verifies the excessive permanence of the elderly in a specific environmental unit that is indicative of a state of health or changes in user's behavior or mood. Interventional therapies exist to act on particular signals of ill health. Night walking or excessive stay in the bathroom may be symptomatic of sleeping interruption or a sudden illness and may be detected by a bed sensor. The level of user activity is also indicative of a particular emotional state, such as the presence of anxiety or depressive disorders. The platform also allows the monitoring of vital parameters be measured remotely (blood pressure, weight, blood sugar, ...); within the acceptability threshold set in the IT device, it is possible to activate preventive behavior actions by the various operators in the assistive and health-care sector (doctors, nurses, pharmacists, ...). This integrated system supports the feedback by end-users, as essential to support the older persons in self-management of their health state and to improve their quality of life as they age. The platform is able to manage, finally, a series of information on the level of safety and use of energy at home. The control and monitoring of energy consumption or equipment uses give specific information about their uses and make users aware of the potential costs' savings obtainable. User involvement is an essential part of the project's development: the elderly are educated in the use of digital technologies and receive information and guidance to improve their health or mood.

Protocol

wired KNX

wireless

Producer / Research centre

Fujitsu, Netwelle Centre, Casala

Typology

A - actuator

B - bus connectivity

G - gateway

IC - communication interface

IP - interactive platform (app)

SD - smart device

SM - smart meter

SO - smart object

SS - smart sensor

Function

activation

communication with end-user

control

data collection

monitoring

transmission of Informations

Service

AAL - Assisted Living

COM - Comfort

NRG - Energy

SAE - Safety & Security

Position

indoor

outdoor

Functionalities and parameters

accelerometer (earthquake)

activity

air velocity (wind)

artificial light.

breath command

CO2 concentration, VCO

consumptions (water, gas, electricity)

emergency (building system)

emergency (user)

falls

fire presence

gas & smokes presence

humidity

incontinence

movement (users and animals)

natural light

night light paths

open / close

presence (users and animals)

rain

tumor / sound

sleeping quality

temperature

vital parameters

vocal command

water leak presence

Figure 3: App Your Wellness (Great Northern Haven) datasheet

issue on Tools, technologies and systems integration for the Smart and Sustainable Cities to come [16].

References

- [1] Good N, Martinez Cesena EA, Mancarella P. Ten questions concerning smart districts. *Building and Environment* (118) (2017):362-376. <https://doi.org/10.1016/j.buildenv.2017.03.037>
- [2] Yan D, Hong T, Dong B, Mahdavi A, D'Oca S, Gaetani I, Feng X. IEA EBC Annex 66: Definition and simulation of occupant behavior in buildings. *Energy and Buildings* 156 (2017): 258-270. <https://doi.org/10.1016/j.enbuild.2017.09.084>
- [3] Frederiks ER, Stenner K, Hobman EV. Household energy use: Applying behavioural economics to understand consumer decision-making and behaviour. *Renewable and Sustainable Energy Reviews* (41) (2015) pages 1385-1394. <https://doi.org/10.1016/j.rser.2014.09.026>
- [4] Tianshu W, Zhu Q, Yu N. Proactive demand participation of smart buildings in smart grid. *IEEE Transactions on Computers* 65 (5)(2015): 1392-1406. <https://doi.org/10.1109/TC.2015.2495244>
- [5] Palensky P, Dietmar D. Demand side management: Demand response, intelligent energy systems, and smart loads. *IEEE transactions on industrial informatics* 7 (3) (2011) pages 381-388. <https://doi.org/10.1109/TII.2011.2158841>
- [6] SCIENTIFIC BOARD FOR JPSC SPECIAL ISSUE, Joint Programme on Smart Cities. EERA Joint Programme on Smart Cities: storyline, facts and figures. *TECHNE - Journal of Technology for Architecture and Environment, [S.l.]* (1) (2018) pages 16-25 <https://doi.org/10.13128/Techne-23566>
- [7] Antonini E, Mussinelli E. Toward the smart city and beyond. *TECHNE-Journal of Technology for Architecture and Environment, [S.l.]* (1) (2018), pages. 26-27. <https://doi:10.13128/Techne-23567>.
- [8] SET-Plan ACTION n°3.2 Implementation Plan. Europe to become a global role model in integrated, innovative solutions for the planning, deployment, and replication of Positive Energy Districts. (2018). Available online at:https://setis.ec.europa.eu/system/files/setplan_smartcities_implementationplan.pdf [Accessed on 01 Sept 2019].
- [9] Pinna R, Costanzo E, Romano S. (2018). Pathways to ZEED. *TECHNE-Journal of Technology for Architecture and Environment*, (1), pages 40-44. <http://dx.doi.org/10.13128/Techne-22736>
- [10] World Economic Forum (2015). *Inspiring Future Cities & Urban Services. Shaping the Future of Urban Development & Services Initiative, Global Survey on Urban Services*. Available online at: http://www3.weforum.org/docs/WEF_Urban-Services.pdf [Accessed on 01 Sept 2019].
- [11] JPI Urban Europe. Strategic Research and Innovation Agenda 2.0. Full Draft. (2018) Available online at <https://jpi-urbaneurope.eu/about/sria/>
- [12] McKinsey Global Institute (2018). *Smart Cities: digital solutions for a more livable future*. Available online at: <https://www.mckinsey.com/~media/mckinsey/industries/capital%20projects%20and%20infrastructure/our%20insights/smart%20cities%20digital%20solutions%20for%20a%20more%20livable%20future/mgi-smart-cities-full-report.ashx> [Accessed on 01 Sept 2019].
- [13] Ahlgren B, Hidell M, Ngai EC. Internet of things for smart cities: Interoperability and open data. *IEEE Internet Computing* 20 (6) (2016). pages 52-56. <http://dx.doi.org/10.1109/MIC.2016.124>
- [14] Integrated and Replicable Solutions for Co-Creation in Sustainable Cities. Available online at <https://irissmartcities.eu/content/5-iris-transition-tracks> [Accessed on 01 Sept 2019].
- [15] Maestosi PC, Civiero P, Romano S, Botticelli M. Smart home network for smart social housing: A potential to boost the dignity of mankind. In *Proceedings of the 42th IAHS World Congress The Housing for the Dignity of Mankind, Naples, Italy 2018 Apr* (pp. 10-13). Available online at http://sue.enea.it/wp-content/uploads/2017/11/paper-IAHS2018-ID014_20180215-ottimizzato.pdf [Accessed on 01 Sept 2019].
- [16] Østergaard PA, Maestosi PC. Tools, technologies and systems integration for the Smart and Sustainable Cities to come. *Int J Sustain Energy Plan Manag* 2019;24 2019. <http://dx.doi.org/10.5278/ijsepm.3450>



Experimental demonstration of a smart homes network in Rome

Sabrina Romano^{*,a}, Martina Botticelli^b and Francesca Dionisi^{a,c}

^a Smart Cities and Communities Laboratory, ENEA – Smart Energy Division, Casaccia, 00123 Roma, Italy

^b Department of Information Engineering Marche Polytechnic University, 60131 Ancona, Italy.

^c PDTA, La Sapienza University, 00185, Rome, Italy.

ABSTRACT

According to the European Strategy Energy Technology (SET) Plan, the resident-user engagement into the national energy strategy is pivotal to the project as it is considered to be one of the most important challenges. The Italian Minister of Economic Development and ENEA has entered into a Programme Agreement for the execution of the research and development lines of General Interest for the National Electricity System. In particular, as part of the “Development of an integrated model of the Urban Smart District” a Smart Home network experimentation has been carried out in Centocelle, in the south-eastern outskirts of Rome.

This project aims to develop a replicable model able to monitor energy consumption, indoor comfort degree and safety in residential buildings. Then raw data are transmitted to a higher level ICT platform where they are analysed and aggregated to provide the user and the community with a series of constructive and valuable feedback. All this information can shed light on the user’s behaviour patterns and what ought to be improved to increase their energy awareness. The heart of the system is the Energy Box (EB) that allows to control all the devices (sensors and actuators) and to transform each and every home into an active node of a smart network. It lets the user share data and information with the outside world as well as to increase residents’ sense of involvement and belonging to the community, providing them with new forms of interaction. In perspective, the system architecture aims to transform each user from a mere consumer into an active participant in the energy market, able to control demand (demand-side management). Finally, the brand-new home digital infrastructure is paving the way to a series of additional services, such as assisted living and home security.

Keywords:

Smart home;
Users’ energy awareness and feedback;
Energy aggregator;
Smart services;
Wireless sensors;

URL: <http://doi.org/10.5278/ijsepm.3335>

1. Introduction

Growing awareness of the world’s energy scarcity and environmental issues has introduced new conditions within the energy system. An emblematic example is an electrical system, which, in the future, will have to accommodate a share of production much greater than today. This issue poses new challenges to the power generation system and end-user energy consumption behaviour. The current trend points to the direction of changing the network to manage future challenges, such

as energy storage availability and flexibility, and as well as improving the balance between energy production and consumption. Also it is thought to support the transition towards Zero Energy Emission Districts (ZEED) in the near future [1]. As a result of this development, a large number of programmes have been implemented in Europe and the World over. The first generation of these projects was focused on technology and electrical grids, while social and behavioural issues were overruled or not sufficiently detailed. In recent years, as several case studies have shown, behavioural supporting measures

*Corresponding author - e-mail: sabrina.romano@enea.it

Acknowledgement of value

The added value of the “Experimental demonstration of a Smart Home network in Rome” for ARETI is the first, needful and concrete step toward the inclusion of end-users into the optimised management of the grid, with the scope to foster decarbonisation and avoiding an unnecessary investment on wiring as much as possible. This goal is reached by increasing the capability of the actual network to transfer energy to end-user by harmonising and balancing the customer’s load throughout the day: this can be only achieved having, simultaneously, DSOs equipping their network with proper “flexibility management systems” and Customers adopting “Smart Home” philosophy/technology.

Ercole De Luca, Innovation – Grid Flexibility & Dispatching, Areti

proved valuable to make users feel more involved in the project and help them gain an advantage in terms of energy savings.

For this purpose, in December 2015 the public consultation process was dedicated to the 2nd Energy Union Research, Innovation and Competitiveness common priority, for “facilitating the participation of consumers in the energy transition through smart grids, smart home appliances, smart cities, and home automation systems” [2].

This paper aims to describe ENEA Smart Home Model developed to increase awareness on energy-saving issues throughout the adoption of IoT technologies. Not only do smart technologies help people save energy, but they can also improve comfort and convenience at home by offering innovative services. It examines the experimentation of a smart home network, describing the technological solution and giving a brief outline of the methodology. Drawing from available studies, we estimate household energy savings relative to average energy consumption for each household. Additional research will improve these estimates in the next years. Furthermore, the experimentation was evaluated in terms of people’s satisfaction with the technology in use from a social and psychological point of view.

2. System technological infrastructure

Prior to the start of the experimentation, a study was conducted on the state of the art in order to define the necessary requirements and identify the best technological solutions. The SNH system design is based on those requirements that the identified technological solutions are able to supply, i.e. the use of standard and open communication protocols or the adoption of wireless devices, easy to install and quite inexpensive [3][4][5]. In collaboration with Apio company, ENEA has designed a Smart Home System and Aggregation platform [5] to provide

guidelines for more efficient and energy-aware behaviour. SHN enables the exchange process between homes and the Aggregator to manage user flexibility and benchmarking.

Nowadays, Smart Home market and particularly IoT is constantly growing (185 million Euros, + 23% compared to 2015) [6] but, until now, it has been mainly driven by security issues, despite technology rapid progress promises to make more features available in the near future [7].

Smart homes use technologies like smart thermostats, appliances, and lighting to enhance residents’ comfort and convenience in their homes. These technologies connect to one another through home wireless networks and to the larger world through the Internet. Using software, sensors, and other hardware, they monitor and control the home’s systems and allow residents to access them when they are away. The heart of the system is the Energy Box (EB) that continuously collects data on energy performance. It can communicate wirelessly with other devices installed at home through standard and open communication protocols and acts as a gateway for the information transfer to the external I-cloud via WiFi and/or Ethernet. The connection architecture is described in the following figure.

The smart toolkit is made up of sensors that adopt a single communication protocol, Z-Wave, for monitoring electricity consumption and indoor comfort. They can also control some thermal and electrical utilities. In particular, the following devices have been installed as shown in figure 2:

- Electric Smart Meter, installed in the apartment electrical panel underneath the general switch for monitoring the overall apartment electricity consumption;
- Smart Switch for monitoring consumption and controlling air conditioners;
- Smart Plug for monitoring and controlling several electrical devices (e.g. appliances);

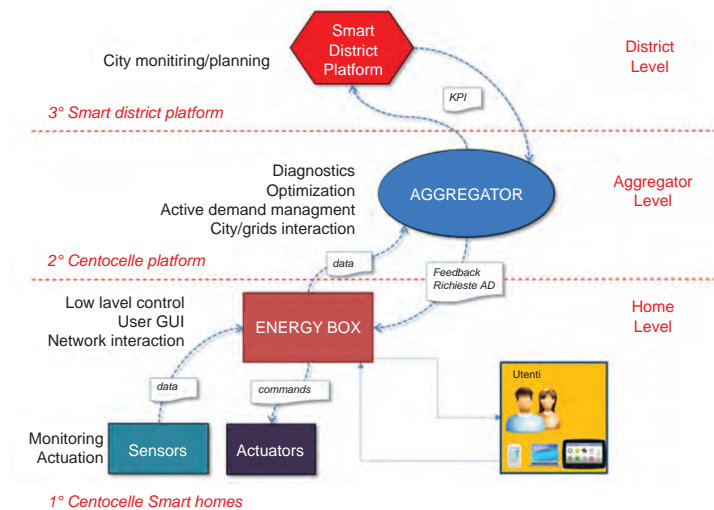

Figure 1: Connection architecture

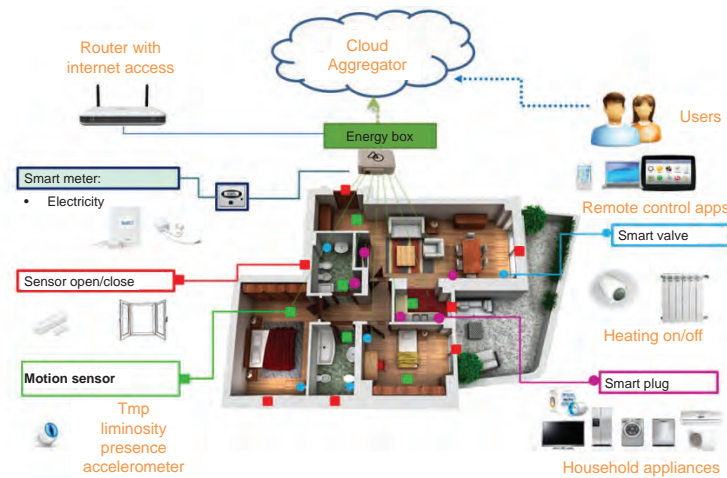

Figure 2: Smart home toolkit

- Opening and closing sensors on doors and windows;
- Integrated comfort/presence sensors for monitoring indoor temperature, brightness and user presences.
- Smart valve for monitoring and controlling the radiator set point.

Each device matches a web-APP, accessible from a computer or mobile phone, for real-time display of sensors' acquired data. The web-app controls the actuators, such as the smart plug and smart valve.

3. Data Collection and Analyses

This project aims to develop a system of SHN able to monitor energy consumption, the degree of comfort and safety in residential buildings. All acquired data are then

transmitted to a higher level platform where they are stored, analysed and aggregated. In coming years, efforts in data analytics to disaggregate smart technology-generated data into meaningful, actionable findings will be also quite useful to streamline data processing. The goal is to reduce the final domestic energy consumption leading users through a path of growth of energy awareness as well as offering additional services. In addition, the Smart Home infrastructure can enable the home user to demand response services. In perspective, users can modify their energy demand in response to requests from an Aggregator, receiving a reduction of the energy cost in return.

a. Energy Feedback

A dashboard was designed to provide users with valuable feedback [9]. It guides users towards more ener-

gy-efficient behaviour to help them better understand how much energy they are using in their daily activities. As users become more aware of their energy consumption they can change their energy-related behaviour as well as shift their operation to off-peak hours when, for instance, there is higher availability of energy from renewable sources. As a result, residents who use feedback from these devices can further adjust their energy use, reducing their energy footprint. In fact, providing the user with information about their past and present energy consumption has the ambition of modify their behaviour. To support users during the process, technical vocabulary has been translated into terms easier to understand, such as cost or bill. Finally, a web-app was developed to give users real-time feedback and an overview of their energy consumptions [8].

The following set of information is provided within the App:

- Generic information: map position, house size and family unit composition;
- Weather conditions, external temperature compared with the average internal temperature, window opening percentage;

- Estimated monthly electricity consumption for the date of access to the App in both kWh and €

Each and every user may choose whether to compare their results with themselves or other participants. In the dashboard section called “My consumption”, for the chosen reference time interval, you can view:

- Daily energy consumption: using a bar chart showing the consumption in kWh and the costs in €, and comparing them with the average value, as to easily identify in which day or hour the higher consumption was recorded. It shows the user when and where their consumption is.
- Distribution of consumption among monitored household appliances. In this way, it is feasible to identify for which users the highest consumption is recorded and the respective incidences on the bill costs.
- Comparison of monthly consumption for the current year with the previous one. The comparison makes it possible to monitor whether there has been an improvement in the user’s behaviour or if there are savings compared to the previous year when no control system was going on.

Table 1: User interface: My progress - Comparison with others



- In the section called “With others”, the consumptions of the selected time interval are compared with families similar by composition. In this case, the provided set of information is:
 - Comparison with the average and the most efficient among similar users: the comparison is carried out in percentage. A comment follows that can be “Attention” you are consuming more than the average of similar users or, “Congratulations” if the consumption is lower.
 - Comparison between the consumption of household appliances of the single user with the users’ average consumption of the same category.

b. Additional services

From the very beginning home users were offered a bunch of additional services. Thanks to local processing capabilities, it looks feasible to manage situations of potential risk [9]. Incorporating heterogeneous data is vital to decision support, with a consequent reduction in costs and user satisfaction.

The additional services offered are described below:

- Security – services which provide, when an end-user is away, home detection or the break-in of the locking systems. The system is able to provide a warning notification to the end-user or third party specifically enabled;
- Safety – services which monitor specific environmental parameters (smoke detectors, CO₂, flood sensors, etc.) and to detect particular risk situations to prevent injuries and disasters;
- Assisted living - services to support vulnerability and to improve quality of life.

4. Experimental demonstration

Beginning in May 2018, pilot testing [10] of the Smart Homes network was started in Centocelle, a suburb in the south-eastern district of Rome [11]. During the recruitment phase, to reach out to a wider range of neighborhood inhabitants, a series of meetings were organized with active social groups. In addition, various multimedia tools were used to convey the project [12]. The table 2 below describes the characteristics of the apartments and users’ profile.

Table 2. Building typology and users’ profile

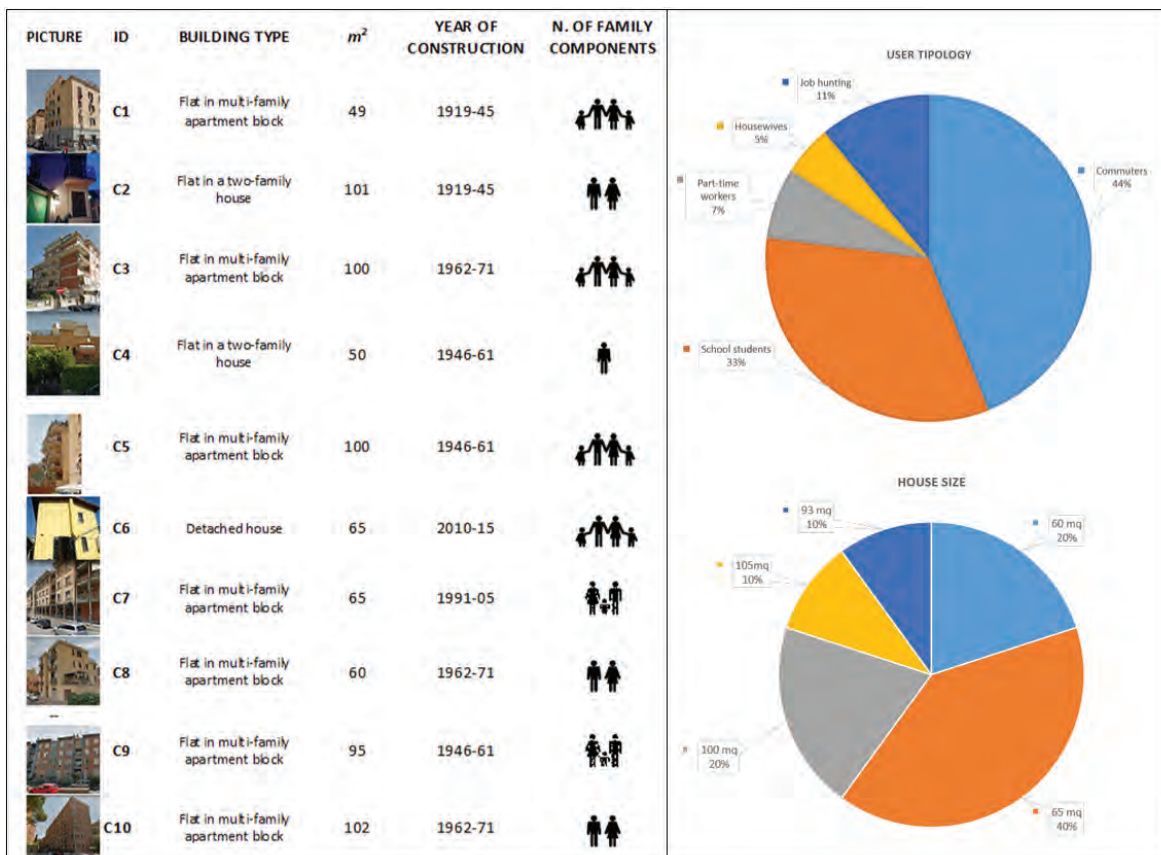

During the trial period, 10 families spontaneously joined the project. At first, participants were given a questionnaire on the basis of which simulations were carried out. Results made it possible to estimate home consumption [13][14], to profile the type of user and allow evaluation and benchmarking. Simply comparing the actual bill electricity consumption and the estimated consumption based on the information provided by participants, it was found that in most cases users consume more than it was expected, and this percentage was approximately 30%. This analysis, carried out even before the experiment started, confirmed the lack of awareness the majority of users involved in the trial project had. Furthermore, the 2017 electricity bills related data, based on real consumptions, were then compared with the typical electricity consumption available in Italy, issued by the Electricity and Gas Energy Agency (AEEG)[15] and by the Italian Institute of Statistics (ISTAT)[16]. The comparison was carried out among homogeneous groups, i.e. families similar in terms of the number of components. This process has helped identify the most energy-consuming users and those in need of efficiency improvements. However, findings suggest that families involved in this experimentation presented lower levels of energy consumption compared to the Italian average values, as shown in the following graph.

5. Results discussion

Data collecting method of electricity consumption made it feasible to verify the results of the experimentation in terms of families' savings on electricity bills. The following graph shows the average monthly consumption and the percentage of savings. Results suggest that the average savings were about 10% for each household, even though the greater incidence was found in single or two-component families, where the effects of the individual user lifestyle changes and habits are more evident.

Generally speaking, the results can be regarded as positive, especially considering that it is mainly due to a change in the users' behaviour, given that no automatic control was on, not to mention the real-time feedback and competition naturally spreading among users. Furthermore, we carried out a comprehensive survey of technology user-friendliness. For this purpose users were given a questionnaire with the result that the technology in use has gained a widespread acceptance, even if improvements have been requested especially in terms of product customisation. To realise the full potential of smart technologies, consumer acceptance must evolve beyond early adopters [17], and reach the broader population even if the survey showed that mounting cybersecurity threats and breaches were one of the most

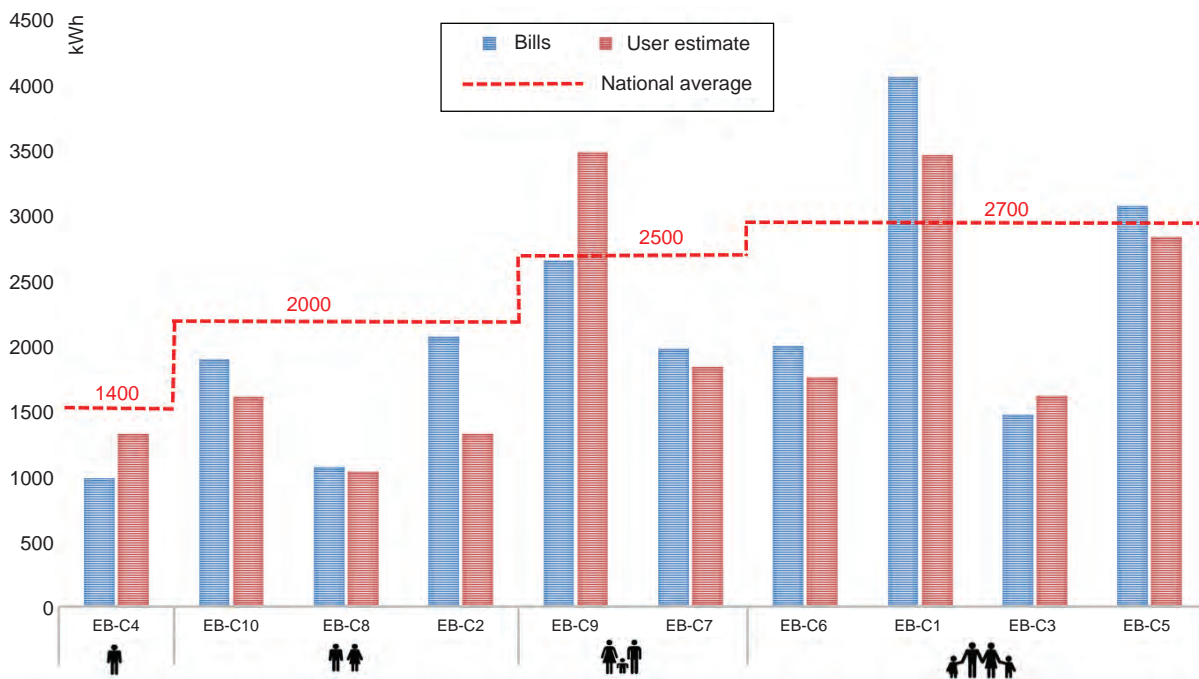

Graph 1: Comparison of real annual electricity consumption estimated by the user compared to the national average by type of family

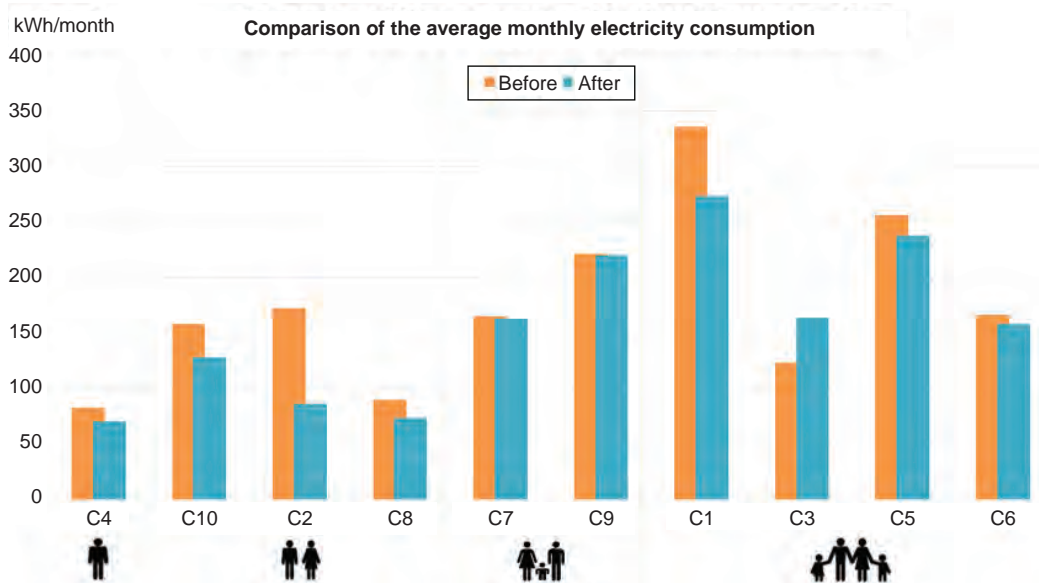

Graph 2: Comparison of the average monthly electricity consumption before and after the trial project

sensitive issues. Users have been reassured in this regard. Home data are acquired anonymously and are not sold to third parties, but exclusively used for benchmarking as well as the tracing of user energetic profile and behaviour was rendered unfeasible to one another.

5. Conclusion

The deployment progress has shown the possibility to actively engage home users. The average saving was approximately 10% on electricity consumption per household due to the technological solution in place. Several DSOs and electric utilities have currently shown interest in this experimentation as it allows the use of flexible resources that lie among residential users, while the technological solution has proved to enable the active involvement of the end-users in the advanced network management. In coming years, further step will have to be taken to build up strong foundations of a real energy community, integrating smart sensors and a brand-new type of energy meters with accounting and exchange certification systems. The aim is to maximise the use of renewable sources by exploiting storage and energy exchange within the same smart energy community [18]. Nevertheless, it should be considered that many smart home technologies are wireless, which means they need their energy requirements to support their sensing, communication and control capabilities always being in network standby mode. This could diminish any incremental energy savings and it should

be taken into account when evaluating the energy performance of any smart technology system.

Acknowledgements

This article was invited and accepted for publication in the EERA Joint Programme on Smart Cities' Special issue on Tools, technologies and systems integration for the Smart and Sustainable Cities to come [19].

References

- [1] Pinna R, Costanzo E., Romano S., Parways to ZEED, *TECHNE Special Issue 012018;1*. <http://www.fupress.com/techne> DOI: 10.13128/Techne-22736
- [2] <https://setis.ec.europa.eu/implementing-integrated-set-plan/smart-solutions-consumers-ongoing-work>
- [3] S. Aman, Y. Simmhan, V. K. Prasanna, University of Southern California, "Energy Management Systems: State of the Art and Emerging Trends", *rivista IEEE Communications Magazine* – (s.l.) IEEE, January 2013 -1: vol 51, pp: 114–119
- [4] L.Liu, Y. liu, L. Wang, A.Zomaya, S.Hu, "Economical and Balanced Energy Usage in the Smart Home Infrastructure: A Tutorial and New Results", *IEEE Transactions on Emerging Topics in Computing* (Volume:3, Issue: 4) pp: 556–570.
- [5] <https://www.smarthome.enea.it/>
- [6] Politecnico di Milano, "Internet of things: oltre gli oggetti, verso i servizi" : Milan, Italy, April 21, 2017. https://www.osservatori.net/it_it/catalogsearch/result/index/?format=102&q=internet+of+things%3A

- [7] Energy Impacts of Smart Home Technologies Jen King April 2018 Report A1801 <https://aceee.org/research-report/a1801>
- [8] Tiago Serrenho, Paolo Zangheri, Paolo Bertoldi " Energy Feedback Systems: Evaluation of Meta-studies on energy savings through feedback". <https://ec.europa.eu/jrc/en/publication/eur-scientific-and-technical-research-reports/energy-feedback-systems-evaluation-meta-studies-energy-savings-through-feedback>
- [9] Taraglio S, Chiesa S, La Porta L, Pollino M, Verdecchia M, Tomassetti B, et al. DSS for smart urban management: resilience against natural phenomena and building heat dispersal assessment. *Int J Sustain Energy Plan Manag* 2019;24. <http://doi.org/10.5278/ijsepm.3338>
- [10] S. Fumagalli, S. Pizzuti, S. Romano, "Smart Home Network: sviluppo dei servizi di aggregazione e progettazione di un dimostrativo pilota". Report RdS/PAR2016/006. http://www.enea.it/it/Ricerca_sviluppo/documenti/ricerca-di-sistema-elettrico/adp-mise-enea-2015-2017/smart-district-urbano/rds_par2016_006.pdf
- [11] Cassinadri E, Gambarini E, Nocerino R, Scopelliti L. Sharing Cities: from vision to reality. A people, place and platform approach to implement Milan's Smart City strategy. *Int J Sustain Energy Plan Manag* 2019;24. <http://doi.org/10.5278/ijsepm.3336>
- [12] Meloni C, Cappellaro F, Chiarini R, Snels C. Energy sustainability and social empowerment: the case of Centocelle smart community co-creation. *Int J Sustain Energy Plan Manag* 2019;24. <http://doi.org/10.5278/ijsepm.3339>
- [13] L. de Santoli, F. Mancini, M. Cecconi, C.I.T.E.R.A - Centro di Ricerca Interdipartimentale Territorio Edilizia Restauro Ambiente Sapienza Università di Roma "Sviluppo di una procedura semplificata per la valutazione del potenziale di aggregabilità di utenze residenziali". Report RdS / PAR2016 / 009 http://www.enea.it/it/Ricerca_sviluppo/documenti/ricerca-di-sistema-elettrico/adp-mise-enea-2015-2017/smart-district-urbano/rds_par2016_009.pdf
- [14] P. Cannavò, C. De Angelis, E. De Nictolis, C. Iaione, A. Noce, A. Palladino, S. Parlato, C. Prevete, C. Rocca, B. Sdao. Libera Università Internazionale degli Studi Sociali Guido Carli (LUISS), "La pratica e la prototipazione della co-governance per uno smart district urbano", Report RdS/PAR2016/026. http://www.enea.it/it/Ricerca_sviluppo/documenti/ricerca-di-sistema-elettrico/adp-mise-enea-2015-2017/smart-district-urbano/rds_par2016_026.pdf
- [15] Agenzia per l'Energia Elettrica e Gas (AEEG). <https://www.autorita.energia.it/it/index.htm>
- [16] Istituto Nazionale di Statistica, ISTAT. <http://www.istat.it/it/>
- [17] Botticelli M, Dionisi, F. Moneriu A., Romano, S. , A Smart Home Network for Proactive Users. REAL CORP 2019 – IS THIS THE REAL WORLD? Perfect Smart Cities vs. Real Emotional Cities. Proceedings of 24th International Conference on Urban Planning, Regional Development and Information Society. pp. 55-62. ISSN 2521-3938
- [18] Heinisch V, Göransson L, Odenberger M, Johannson F. A city optimisation model for investigating energy system flexibility. *Int J Sustain Energy Plan Manag* 2019;24. <http://doi.org/10.5278/ijsepm.3328>.
- [19] Østergaard PA, Maestosi PC. Tools, technologies and systems integration for the Smart and Sustainable Cities to come. *Int J Sustain Energy Plan Manag* 2019;24. <http://doi.org/10.5278/ijsepm.3450>



International Journal of Sustainable Energy Planning and Management

RESEARCH and EXPERIMENTATION

Spatial aggregation and visualisation of urban heat demand using graph theory. An example from Hamburg, Germany

Ivan Dochev*, Hannes Seller and Irene Peters

HafenCity University Hamburg, Überseeallee 16, 20457 Hamburg

ABSTRACT

Because of the physical properties of heat energy, information about the spatial pattern of building heat demand is important for designing climate protection measures in the heating sector (efficiency improvements and renewable energy integration). Many cities in Germany currently prepare ‘heat demand cadastres’ – thematic maps, depicting building heat demand. The growing trend towards open data points into the direction of making these cadastres public, so that different actors can make use of them. However, making such data public may violate the legal requirement of protecting private data. We present a way of tackling this problem with an approach for the aggregation of spatially represented heat demand. Using an algorithm based on graph theory, we group buildings such that the tracing of energetic characteristics and behaviour to individuals is rendered unfeasible. Our method also allows additional constraints to be introduced, for example, aggregating with respect to plot boundaries. We discuss how the building groups can be visualised in a map by presenting a method of generating customised geometries for each group. Finally, we present a visualisation of both specific heat demand (in kWh/(m²*a)) and total heat demand (in kWh/a) in one and the same map. This aids the analysis of more complex questions involving energy efficiency and heat supply.

Keywords:

Urban heat demand;
Data protection;
Aggregation;
Graph theory;
Visualisation;

URL: <http://doi.org/10.5278/ijsepm.3346>

1. Introduction

The building sector is a large contributor to CO₂ emissions (in the higher latitudes mainly through space heating). Reducing these emissions through energetic refurbishing of buildings and integration of renewable energy sources has become a major focus of climate protection policy. So-called “Urban Building Energy Models” (UBEMs) [1] are being developed to support these measures. With the use of GIS, these models become spatial models, allowing the visualisation of the spatial pattern of heat demand in thematic maps, or “heat demand cadastres”. Space is of the essence in heat planning as heat transport (distribution grids) is traditionally associated with losses and costs. Renewable energy sources, on the other hand, are in many cases

local and their utilisation also requires understanding the spatial patterns of demand and supply.

At the same time the need for more cooperation and coordination between public and private actors in urban planning as defined for example in the Copenhagen Charter [2] has caused spatial data to be made increasingly public. There are currently many examples of municipal and regional authorities that operate geoportals allowing open access to numerous spatial datasets - natural environment, built environment, technical and transport infrastructure and many more. This trend has also reached the energy sector with the introduction of publicly accessible energy-relevant datasets on both the supply and the demand side – e.g., solar or geothermal energy potentials but also building energy demand maps.

*Corresponding author - e-mail: ivan.dochev@hcu-hamburg.de

Acknowledgement of value

Solving the data protection issue when developing the Hamburg Heat Demand Cadastre proved to be much less trivial and more practically difficult than we expected. The presented aggregation method is what we currently use, without it, we would not have been able to publish the cadastre in its current form.

Mr. Roland Schwörer, Renewable Energy– Heat Concepts, Hamburg Ministry of Environment and Energy

However, energy consumption and demand reflect personal behaviour as well as the condition of property such as buildings (which to a large extent are privately owned). Therefore, a potential conflict arises between the need for open data and the need for personal data protection. Different countries and authorities go about this issue in different ways. We concentrate on the case of Germany, where data protection requirements in this context are relatively strict.

The context in which this paper originated was our work on the GEWISS Project Hamburg [3] and our cooperation with the Hamburg Ministry of Environment and Energy (*Behörde für Umwelt und Energie - BUE*) in developing the Hamburg “Heat Demand Cadastre” (*Wärmekataster*), which was published in 2017. The cadastre is a thematic map depicting demand for space heating and hot water. It is based on consumption-corrected heat demand values from the IWU Typology [4] and the German VDI standard [5]. See [6] for methodological details

Since many buildings are privately owned, however, the cadastre had to adhere to data protection requirements. Even though the heat demand at the building level was only *estimated* based on the type and age of the building (no measured consumption), it could not be released as it was, but had to undergo aggregation. The aggregation requirement defined by the BUE states that aggregated building groups had to include a minimum of five units. A unit in a residential building is the dwelling unit, while each non-residential itself comprises a single unit.

This definition raises some questions, in particular who is to be protected: Individuals in their function of building users or real estate property owners? While this is still to be explored, we developed a method for performing the required aggregation, which provides the flexibility to be adjusted for alternative formulations of the aggregation criterion that might be developed in the future (e.g., a change in the minimum required count for each group).

We also added some further requirements to increase the usability of the cadastre. The purpose of heat demand

mapping is to support planning. For strategic energy planning at the city level, the size of the aggregation units may be less important. However, for the concrete planning of individual projects, a finely grained heat demand map is very useful, even necessary, as the location of energy sources in relation to energy sinks is a major criterion for project viability. Additionally, data at a coarser spatial level run into averaging-out effects that mask spatial variability. To avoid this, we set a requirement to aggregate only until the minimum data protection requirement was achieved.

In addition, heat demand maps greatly facilitate the analysis of potential for district heating, which is considered a key technology for a sustainable heat supply in urban contexts with a high share of a relatively inefficient building stock. Since district heating infrastructure tends to follow the street network of a city, the method presented here respects the street layout of a city. It goes without saying that the aggregation should partition the urban space, i.e. form groups that do not spatially overlap, as this would counteract the consideration of the intrinsically local nature of heat energy.

Finally, aggregation in thematic maps can be split into two distinct tasks – defining the aggregated groups and defining the geometry to represent them, the latter being a non-trivial issue. The requirements for the algorithm were then: (i) grouping buildings to satisfy a minimum unit count, (ii) optimising unit count to make it as close to the required minimum as possible, (iii) producing spatially non-overlapping groups that respect the street layout, and (iv) generating a geometry for each individual group.

2. State of the art

The easiest way of approaching the aggregation task is to use existing spatial units like census tracts, postal code areas or similar. However, all of these units are predefined which lowers the flexibility of the aggregation and does not satisfy (ii). The “urban block” unit (the areas in-between the street network) comes close to satisfying all requirements for aggregation. Urban blocks

per definition follow the street layout (iii) and have a known geometry already made available by the public authorities of Hamburg (iv). A further argument for their use is that some official data, mainly about demography, is available at this level. Having energetic data at an aggregation level which corresponds to an official unit of governmental statistics allows for multi-sectoral analysis (for example analysing connections between heat demand and socio-demographic data). Although the urban block only partially satisfies requirements (i) and (ii), we use it as a starting point of our aggregation.

An alternative to existing spatial units is the use of a raster grid. The first problem with this approach is that the resulting groups depend on the raster grid position. Shifting the grid around in the Cartesian plane would change the content of each cell. In other words, the allocation of a building to a cell is arbitrary and depends upon the initial position of the raster. A further problem is that it does not satisfy the requirements for having as few units as possible (ii) and following the street layout condition (iii).

Note that we do not consider our task to be a “clustering” task in the normal sense. Cluster algorithms, although a broad group of algorithms, are generally designed to optimize for within-group homogeneity and between-group heterogeneity and have an exploratory character. Our task was not exploratory. We had to first group in such a way that each group has a minimum size, while having homogeneous groups (“clustering”) was a secondary objective. The difference is subtle. An example is the standard “k-means” method. It requires a desired number of clusters as input, while we needed a desired minimum count within the clusters.

3. Literature review

In the area of energy planning, the focus is increasingly on the spatial dimension of consumption and generation and numerous tools are being developed for simulation and optimization at local levels [7–11]. Simultaneously, as decentralized generation leads to the emergence of “prosumers”, ICT allows for new forms of public participation [12–14].

In cartography, the problem of building aggregation is part of the broader map generalisation problems. Weibel and Jones [15] summarise that there are two forms of generalisation – one is cartographic, where the goal is high quality map symbology at different scales and database generalisation, with the goal of deriving reduced databases for storage or computational efficiency, and

two, as a pre-step to cartographic generalisation. Data protection could fall into the second category, but we could not locate examples for this in the context of urban energy mapping.

There is however a body of literature on spatial grouping and generalisation of objects. Yan et al [16] propose using Delaunay Triangulation to describe adjacency relations, filter the connecting triangles and then calculate building parameters (size, orientation, shape) to arrive at building groups. Wang and Eick [17] use a contour-line based density algorithm to derive polygons from point objects and then a Poly-SNN algorithm to cluster the polygons into new polygons. Beilschmidt et al [18] use a quadtree for the description and fast query of adjacent points. In a similar context to Beilschmidt but using Delaunay triangulation is the work by Jänicke et al. [19].

Most of these works were designed in the different, broader, context of point aggregation. The closest to our work is the work by Yan et al, but the specifics of our context – finding a balance between map usability for energy planning and data protection – led to differences in the method.

4. Methodology

4.1. Number of units per building

Adhering to the “five plus” rule is not a straightforward task, since the digital cadastre of Hamburg (*ALKIS*) does not contain number of dwelling units per building. Therefore, we need to estimate this value. We intentionally underestimate the unit counts, to err on the side of caution, avoiding the cases where our estimation is too high and a building group is presented as having more than five units, when in reality it has less. We use the number of stories of the building as a proxy for the number of dwellings - assuming that there is at least one dwelling per floor. These assumptions are summarised in Table 1. It is obvious that this leads to an underestimation for most of the buildings, but it is a precaution that serves to make our algorithm safer.

Table 1: Rules for estimating the number of units per building

Building use	Floors	Estimated units
Residential and mixed-use with residential	1 to 3	1
	3 to 5	3
	>5	number of floors
Non-residential	any	1
Any building use without heat demand	any	not considered for aggregation

4.2. Defining the building groups

Since the urban block satisfies many of the defined requirements, we start at this spatial unit. Although most urban blocks contain more than five units, there are a few exceptions. We deal with these by manually merging these few urban blocks with neighbouring ones. Urban blocks with less than five units and very small heat demand are filtered out. We could tackle this in an automated way, but since these exceptions are few and far between, we leave this as a manual step prior to running the algorithm.

The idea is to partition the urban block into building groups with a unit count as close as possible to the minimum required. Firstly, all buildings receive an ID corresponding to the ID of the urban block (for example “710005”). Then we group within the urban block by appending an additional integer to the urban block ID – “710005_1”, “710005_2” etc. The problem then lies in generating the additional IDs in a meaningful way that respects the requirements. There are two obvious possibilities – to group spatially or based on building function. For energy planning, a grouping based on function makes sense, since buildings with different functions have different typical demands and load curves etc. and summary statistics for a group of homogenous buildings are more meaningful. However, this will impede the use of the map, since it is visually difficult to represent spatially intertwining groups of buildings (this is why we have requirement of spatial non-overlap (iii)). For this reason, we group spatially. However, we respect plot boundaries, which tend to encompass buildings of similar use in many cases (see below).

In order to produce spatially clustered groups, we need to describe the spatial relationships between

buildings. We present the method by means of an example urban block (Figure 1). In a first step, we compute all the distances between all pairs of buildings in the urban block. Let this be represented by a complete graph G , where each node is a building and each edge is the straight line between all pairs of two buildings. From graph G , using the Scipy Python library implementation [20] of Kruskal’s algorithm [21], we compute a minimum spanning tree (MST). A MST is such a subtree of G , that spans all the nodes of G and has a total edge length that is minimal compared to all other subtrees of G that span all the nodes of G . The MST is represented with red lines (edges) in Figure 1 (left). Describing the buildings with their MST is advantageous because now we can group by removing edges from the MST (Figure 1 centre). We remove the edges based on their length, starting from the longest. If removing an edge leads to a connected component (group) that is below the minimum dwelling count, we restore the edge and proceed to the next edge. After we have iterated over all the edges we give a unique identification number (ID) to each connected component. Since there are five groups in the example (the small building in the West is an exception, see below) the IDs are from zero to four (due to Python’s zero indexing, see Figure 2).

We then append the ID to the urban block identifier of each building within the same component. Which group receives which ID is irrelevant as long as the IDs are unique and the groups are defined.

In this way, we define the building groups. Although this is the basic logic of the grouping, we introduce two additional rules. Firstly, for the purpose of neighbourhood energy planning, well-defined building complexes

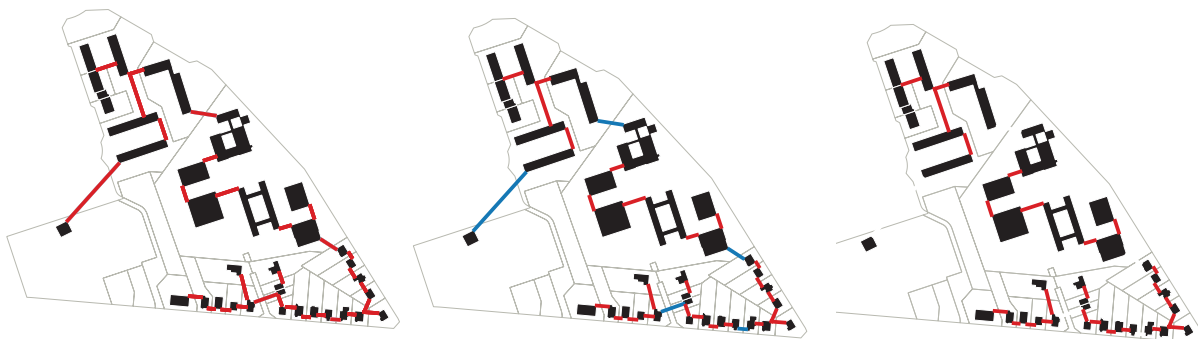

Figure 1: Splitting the minimum spanning tree of the urban block into spatially well-distinguishable groups. Red lines depict the edges of the MST, blue lines the edges that were removed during the aggregation process



Figure 2: Building groups represented with building geometries

of similar use (e.g. large prefabricated apartment blocks, hospital complexes or school campuses) are of great importance, since they are large consumers and can play a role as “anchors” for district heating. Therefore, it would be advantageous to attempt to group the individual buildings in these complexes into the same building groups. Attempting to cluster only spatially will not take this into account in many cases. We use the plot boundaries as a proxy for finding such complexes. For this, we apply an initial re-weighting to the complete graph G . We multiply the distance between two buildings in the same plot with a factor of 0.05. In this way, the MST algorithm considers such edges as being shorter than they truly are and are more often part of the MST. When we then sort the edges based on length, these edges are further down in the list and are less often split. Since building functions generally follow plot boundaries (school or hospital buildings, but also industrial buildings of similar use are usually within the same plot), the algorithm will tend to put them in the same group, although the purely spatial logic might dictate something else.

The second adjustment to the splitting logic is the introduction of a maximum distance between the buildings in a group. There are situations in urban space, where a single building is in a highly isolated location even within an urban block - a small hut within a park complex, or a small workshop in agricultural land on the outskirts of a city. Since such buildings often are irrelevant to the purpose of the mapping (heat demand), the algorithm may split them from a group and note them as

“anonymised”. The behaviour of the algorithm is dependent upon a parameter, which controls how small and how far away does a building have to be to be excluded. Consult the Github repository for more details [22].

4.3. Creating Geometry Representation

After all buildings in the urban block receive a group ID (or are anonymised) the question remains how to present their heat demand. For specific heat demand (i.e. per m^2) at the group level we use the area-weighted average of the specific heat demand [$kWh/(m^2 \cdot a)$]. One way of spatially representing this value is to use the existing building geometries and symbolise each with the colour that reflects the specific heat demand of the building group (Figure 2). The problem is that from the viewpoint of the map user it is difficult to understand that the colours refer to values for the groups and not for the individual buildings. This can be written in the legend, however it is not directly visible. Moreover, when groups have similar values one cannot distinguish which buildings are in which group (for example between 710005_4 and 710005_2). Labelling each group (Figure 3. left) does not help to overcome this. Labelling each building (Figure 3. right) does, but it overloads the map with annotations. An alternative to the building geometry is to use the plot geometry, but plots come in various shapes and sizes and using them as basis fails in areas where there is a single building in a large plot. Therefore, we generate a custom-made group geometry.

We use an approximation of a concave hull using a combination of two polygon buffers. This approach is

referred to as “Aggregate Polygons” available as SQL code at Github [23]. Although we do not use the code itself, we adopt its approach. In essence the method buffers each building geometry outwards at a given distance and dissolves the overlapping polygons to produce a single buffer (Figure 3). Then a second buffer is generated, but with negative distance, which means it buffers inwards from the previous buffer. In the process the areas in-between buildings become parts of the buffer area. The orthogonality of the geometry representation stems from the buffer options. We use a “metre limit” of 2.5 meters, as in [23]. The options for the buffer generation are part of the buffer class of the GEOS library [24].

4.3. Visualisation

There are generally two numeric heat demand characteristics that are used in our context – specific heat demand in kWh/(m²·a) (which can be interpreted as a measure of

energy efficiency) and total heat demand in kWh/a (or MWh/a). While heat loads, heating system types, heating system temperatures or building refurbishment state can also be of interest, we concentrate on the specific and total heat demands, as the most widely depicted in heat demand maps.

If we use the typical coloured filling for symbolising the groups (Figure 4 left), we run into the same issue as the plot representation – if buildings are far away from each other, the polygon will be big and noticeable, but its size is actually irrelevant. The purpose of the polygon representation of the building group is to represent the buildings’ characteristics and designate which buildings are in which group. The size of the polygon however is not in any way a function of any heat demand related characteristics. Buildings with very large footprint areas will have a large polygon representation, but so will small buildings with large distances in-between. In order

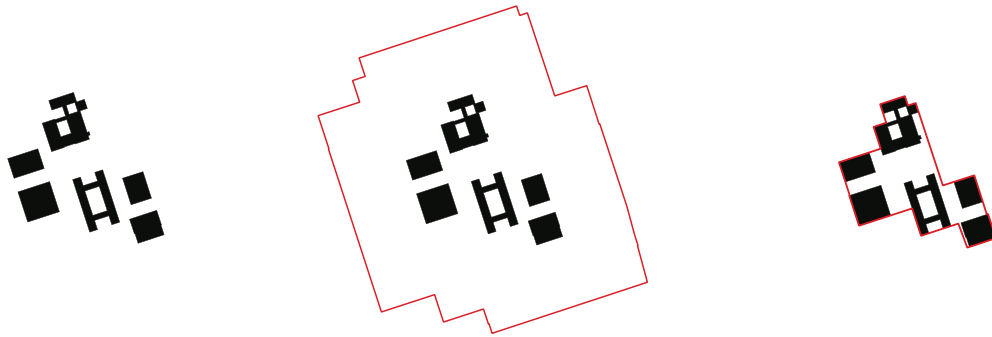

Figure 3: Geometry representation with two buffers. See [23]

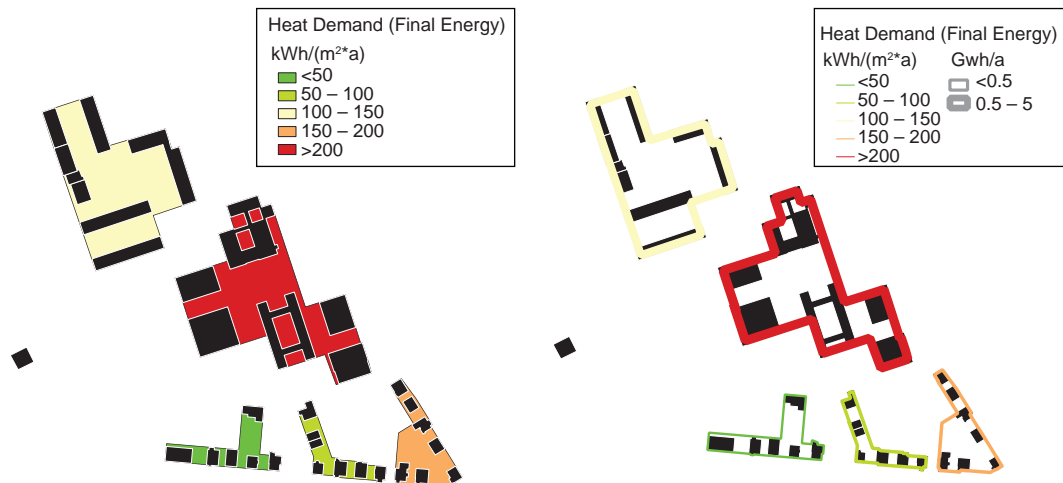

Figure 4: Visualising aggregated final energy

to avoid giving visual significance to the size of the polygon, we use only its outline (Figure 4 right).

We colour the outline based on specific heat demand and additionally adjust its thickness as function of the total heat demand. This has the advantage that it allows a more integrated analysis of heat demand. For example, it allows the quick visual localisation of large ‘heat sinks’ with low or high energy efficiency. This is advantageous for planning since it points towards appropriate measures. For example, a large heat sink with low specific heat demand is likely a target for renewable heat supply, while a large heat sink with high specific heat demand is likely first a target for an increase of efficiency through energetic refurbishment.

For the colour scheme, we use an already relatively known colour scheme in Germany – the green-yellow-red colour gradient of the energy certificates according to the Energy Efficiency Ordinance in Germany (*EnEV*) [25]. We adjust the tone, depending upon the background map and reclassify the scale into 50 kWh/(m²*a) bins, to make the classes more

distinguishable. An important point is to adjust for colour blindness, but this would require changing the basic green-yellow-red palette. This adjustment is beyond the scope of this paper.

4.5. Software used

The presented algorithm was written in Python using the Numpy [26], SciPy [20] and Shapely [27] libraries and the PyQGIS library of the open-source GIS software QGIS [28]. We used QGIS also for the visualisations. The code is available on Github[22].

5. Results

We applied the described methods to a dataset of 300 000 buildings (residential and non-residential) in the city of Hamburg. The algorithm produced 40 000 building groups. The size of the groups was between five and nine units. We use the geometry representation and the visualisation approach to produce Figure 5. We use a digital orthophoto [29] as background map.



Figure 5: Proposed visualisation of the aggregated heat demand (building groups). Background map: [29]

6. Conclusion and Outlook

With the increase in available geodata, protecting privacy in public maps and datasets is gaining importance. Despite rising concerns about the potential violations of data protection requirements, energy policy should be based on quantitative analysis. The difficult, but important task is to find the balance between protecting privacy and retaining usability. This paper is an effort in this direction. There is, of course, room for improvement. The defined rules for the number of units per building are simplified and generalised. They can be adjusted if different strategies for different building types are formulated. For example, data on publicly owned buildings may be considered as not requiring the same extent of data protection as privately owned buildings. The municipality or another public and semi-public entity being the building owner, can agree to make this data public. This can easily be implemented into the algorithm if the function for assigning the number of units is changed so that it assigns a value of five units to publicly owned buildings. Then each public building will have enough units to constitute a building group and the algorithm will attempt to define such a building as a group by itself.

On the visualisation side, large amount of spatial data nowadays include the third dimension. Representing the heat demand of building groups in a 3D visualisation is a further area to be explored.

Acknowledgements

We would like to thank Ms. Lubow Hesse, Mr. Arne Werner and Mr. Roland Schwörer from the Hamburg Ministry of Environment and Energy for the fruitful cooperation. This article was invited and accepted for publication in the EERA Joint Programme on Smart Cities' Special issue on Tools, technologies and systems integration for the Smart and Sustainable Cities to come [30].

References

- [1] C.F. Reinhart, C.D. Cerezo, Urban building energy modeling – A review of a nascent field, *Building and Environment* 97 (2016) 196–202. <https://doi.org/10.1016/j.buildenv.2015.12.001>.
- [2] Danish Ministry of the Environment, Copenhagen Charter 2002: A Statement on the Occasion of the Danish Presidency. European Cities in a Global Era – Urban Identities and Regional Development, 2002. http://naturstyrelsen.dk/media/nst/attachments/92328/era_charter_uk.pdf (accessed 11 April 2018).
- [3] GEWISS Project, GEWISS Geographisches Wärmeinformations- und Simulationssystem [Geographical Heat Information and Simulation System], 2018. <http://gewiss.haw-hamburg.de/>.
- [4] T. Loga, B. Stein, N. Diefenbach, R. Born, Deutsche Wohngebäudetypologie [German residential building typology]: Beispielhafte Maßnahmen zur Verbesserung der Energieeffizienz von typischen Wohngebäuden, 2015. http://www.building-typology.eu/downloads/public/docs/brochure/DE_TABULA_TypologyBrochure_IWU.pdf.
- [5] The Association of German Engineers, Characteristic consumption values for buildings: Characteristic heating-energy, electrical-energy and water consumption values, Beuth Verlag, Berlin 91.140.10, 91.140.50, 91.140.60, 2018. http://www.vdi.eu/nc/guidelines/vdi_3807_blat_2-verbrauchskennwerte_fuer_gebaeude_verbrauchskennwerte_fuer_heizenergie_strom_und_wasser (accessed 16 May 2018).
- [6] I. Dochev, H. Seller, I. Peters, Assigning energetic archetypes to a digital cadastre and estimating building heat demand.: An example from Hamburg, Germany, 2019. Submitted to *Environmental and Climate Technologies*. <https://doi.org/10.13140/RG.2.2.30127.59045>
- [7] J. Knies, A spatial approach for future-oriented heat planning in urban areas, *International Journal of Sustainable Energy Planning and Management* 16 (2018) 3–30. <https://doi.org/10.5278/ijsepm.2018.16.2>
- [8] K. Kuriyan, N. Shah, A combined spatial and technological model for the planning of district energy systems, *International Journal of Sustainable Energy Planning and Management* 21 (2019). <https://doi.org/10.5278/ijsepm.2019.21.8>
- [9] B. Möller, S. Nielsen, High resolution heat atlases for demand and supply mapping, *International Journal of Sustainable Energy Planning and Management* 1 (2014) 41–58. <https://doi.org/10.5278/ijsepm.2014.1.4>
- [10] V. Heinisch, L. Göransson, M. Odenberger, F. Johannson, A city optimisation model for investigating energy system flexibility, *International Journal of Sustainable Energy Planning and Management* 24 (2019). <https://doi.org/10.5278/ijsepm.3328>
- [11] F.J. Miguel, G. Hernández-Moral, V.I. Serna-González, Supporting tool for multi-scale energetic plan through procedures of data enrichment, *International Journal of Sustainable Energy Planning and Management* 24 (2019). <https://doi.org/10.5278/ijsepm.3345>
- [12] E. Cassinadri, E. Gambarini, R. Nocerino, L. Scopelliti, Sharing Cities: from vision to reality. A people, place and platform approach to implement Milan's Smart City strategy, *International Journal of Sustainable Energy Planning and Management* 24 (2019). <https://doi.org/10.5278/ijsepm.3336>

- [13] S. Romano, Experimental demonstration of a smart homes network in Rome, *International Journal of Sustainable Energy Planning and Management* 24 (2019). <https://doi.org/10.5278/ijsepm.3335>
- [14] C. Meloni, F. Cappellaro, R. Chiarini, C. Snels, Energy sustainability and social empowerment: the case of Centocelle smart community co-creation, *International Journal of Sustainable Energy Planning and Management* 24 (2019). <https://doi.org/10.5278/ijsepm.3339>
- [15] R. Weibel, C.B. Jones, Computational Perspectives on Map Generalization, *Geoinformatica* 2 (1998) 307–314. <https://doi.org/10.1023/A:1009748903798>
- [16] H. Yan, R. Weibel, B. Yang, A Multi-parameter Approach to Automated Building Grouping and Generalization, *Geoinformatica* 12 (2008) 73–89. <https://doi.org/10.1007/s10707-007-0020-5>
- [17] S. Wang, C.F. Eick, A polygon-based clustering and analysis framework for mining spatial datasets, *Geoinformatica* 18 (2014) 569–594. <https://doi.org/10.1007/s10707-013-0190-2>
- [18] C. Beilschmidt, M. Mattig, T. Fober, B. Seeger, An efficient aggregation and overlap removal algorithm for circle maps, *Geoinformatica* 35 (2019) 46. <https://doi.org/10.1007/s10707-019-00342-5>
- [19] S. Jänicke, C. Heine, G. Scheuermann, GeoTemCo: Comparative Visualization of Geospatial-Temporal Data with Clutter Removal Based on Dynamic Delaunay Triangulations, in: *Computer Vision, Imaging and Computer Graphics. Theory and Application*, Springer Berlin Heidelberg, Berlin, Heidelberg, 2013, pp. 160–175. https://doi.org/10.1007/978-3-642-38241-3_11
- [20] E. Jones, T. Oliphant, P. Peterson, et al., SciPy: Open Source Scientific Tools for Python, 2001. <http://www.scipy.org/>
- [21] J.B. Kruskal, On the shortest spanning subtree of a graph and the traveling salesman problem, *Proceedings of the American Mathematical Society* (1956) 48–50. <https://doi.org/10.1090/S0002-9939-1956-0078686-7>
- [22] I. Dochev, Aggregating Urban Heat Demand, 2018. <https://github.com/ivandochev/aggregating-urban-heat-demand>
- [23] H. Düster, aggregatePolygons, Düster, Horst, github, 2011. <https://github.com/hdus/pgtools/blob/master/aggregatepolygons/aggregatePolygons.sql>
- [24] S. Santilli, BufferParameters, GEOS Geometry Engine Open Source, 2009. https://geos.osgeo.org/doxygen/classgeos_1_1operation_1_1buffer_1_1BufferOp.html
- [25] Federal Ministry for Economic Affairs and Energy, New energy certificates for residential buildings, 2013. <https://www.bmwi.de/Redaktion/DE/Infografiken/energieausweis.html> (accessed 10 April 2018).
- [26] T.E. Oliphant, A guide to NumPy, Trelgol Publishing, USA, 2006. <http://www.numpy.org/>
- [27] S. Gillies, O. Tonnhofer, J. Arnott, J. Wasserman, A. Bierbaum, A. Adair, J. Schönberger, G. Ouzou, P. Elson, H. Butler, K. Jordahl, K. Wurster, G. Davar, T. Deutsch, D. Collins, F. Junod, B. Hards, D. Baumgold, H. Walshaw, J. Wang, M. Jansen, S. Syrjanen, S.M. Kim, T. Kluyver, M. Tweed, N. Michaud-Agrawal, J. Rao, P. Sagerson, J. Sanford, J. Hall, J. Spencer, S. Hügél, B. Couwenberg, J. Douglass, T. Sauerwein, W. Aiyong, B. Wood, B. Gervais, A. Freeland, B. Root, M. Giu, L. Lima, M. Vermeyen, J. Lostblom, M. De Nadai, J. Euphrosine, Shapely: Manipulation and analysis of geometric objects in the Cartesian plane., 2018. <https://shapely.readthedocs.io/en/latest/>
- [28] QGIS Development Team, QGIS Geographic Information System, Open Source Geospatial Foundation Project., 2018. <http://qgis.osgeo.org>
- [29] LGV Hamburg, Digital Orthophotos 20cm, Landesbetrieb Geoinformation und Vermessung, Hamburg Geoportal, 2016. <https://www.geoportal-hamburg.de/Geoportal/geo-online/>
- [30] P.A. Østergaard, P.C. Maestosi, Tools, technologies and systems integration for the Smart and Sustainable Cities to come, *International Journal of Sustainable Energy Planning and Management* 24 (2019). <https://doi.org/10.5278/ijsepm.3450>

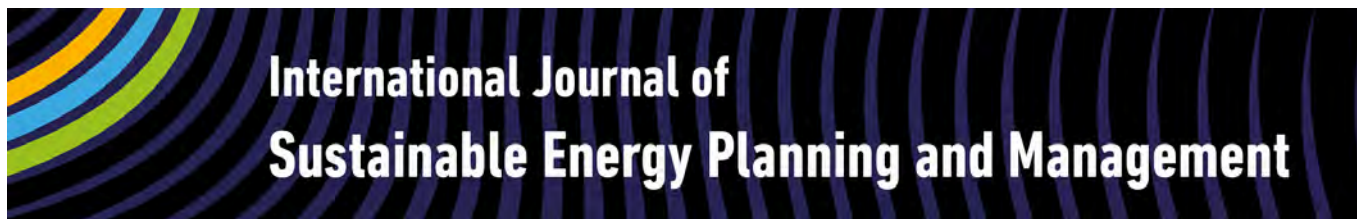

RESEARCH and EXPERIMENTATION

Supporting tool for multi-scale energy planning through procedures of data enrichment

Francisco Javier Miguel-Herrero*, Víctor Iván Serna-González and Gema Hernández-Moral

Fundación CARTIF, Parque Tecnológico de Boecillo, 205, 47151 Boecillo, Valladolid, Spain

ABSTRACT

Considering the challenge of evaluation of the urban environment from the energy point of view, there is plenty of room to improve the resources currently managed by users, enterprises and public institutions. The goal is to create a tool that supports in the decision making in the energy planning process in specific areas by automatically estimating the energy demand and consumption of buildings using public data and representing the results in a geo-referenced way. The tool will provide a better understanding of what the current status of the buildings is, providing these stakeholders with a larger quantity of useful data about the city environment, including not only the geometric information present in cadastre repositories, but also the data collected from the Energy Performance Certificates (EPCs).

In this case, the data from the cadastre repository are combined with the EPCs for each province, with data about the demanded and consumed energy. The objective is to generate a set of buildings typologies for each province with estimated values for the demand and consumption for each building type. These typologies could be used to generate a map with the energetic values for any municipality of this province.

These results can be injected into GIS (Geographic Information Systems) tools that could show these data in order to evaluate the energy demand/consumption of the municipality easing the energy planning decision-making process, or even into databases for further uses.

Keywords:

Energy Planning;
Energy Performance Certificates;
Cadastre;
Data Enrichment;
Building Typologies.

URL: <http://doi.org/10.5278/ijsep.3345>

1. Introduction

Current worldwide problems such as climate change and growing CO₂ emissions, and the corresponding temperature increase, define a reality where it is necessary to act upon. Fossil fuel consumption needs to be reduced, alternative renewable energy sources should be implemented, as well as energy efficiency strategies promoted and refurbishment of the existing building stock aimed for, since it is one of the most problematic sectors in terms of CO₂ emissions.

All of these strategies need to be implemented at different scales, ranging from the European level (e.g. through the implementation of energy directives), to

national and regional scale, and to urban scale, where specific actions can be defined and implemented.

However, these energy planning processes at urban scale are complex, time-consuming and often do not count on the necessary tools to support them, which leads to inadequate assessments and to not progressing at the pace required by the challenges faced.

On the other hand, there is an increasing amount of publicly available data that has not been exploited or put to use to this purpose. In this line, the cadastre and Energy Performance Certificates (EPCs from now on) databases (national and regional respectively) offer a vast amount of data that can result in valuable information to support energy planning processes.

*Corresponding author - e-mail: framig@cartif.es

Acknowledgement of value

From the EREN (Ente Público Regional de la Energía de Castilla y León) institution, we have been presented with the concepts deployed in this article, and express our conformity about what has been shown and also our interest on following the development of the tool for its possible utilization in the terms indicated, considering that they are aligned with our will to improve the services offered to the citizens from our organization.

EREN, Spain

Thus, the aim of this paper is to present a modular software tool that could cover the foretold goals, adding value to the information contained inside the cadastre repository by means of combining these data with the data obtained in the EPCs, in other words, the energy consumption values and CO₂ emissions contained in the EPCs with the geometry of the buildings included in the cadastre registers, starting at City/Municipality level.

Links to previous works

There are several projects that deal with the mapping of energy demand and consumption for energy planning purposes. Some of them estimate energy consumption at the block and lot level of a determined city [1]. Others focus on the calculation of not only energy consumption, but also energy demand based on calculation methods proposed in Energy Performance Certification processes [2,3], whereas there are other examples which combine this with information coming directly from the Energy Performance Certificates database [4].

However, when dealing with estimations of a large number of building blocks this process is highly time-intensive and resource-consuming; on the contrary, the tool proposed offers estimations that could serve to derive similar conclusions to the abovementioned tools, based on reliable data and with a lower resource cost.

2. Methodology

It is important to highlight that the tool has two clearly differentiated parts. The first part corresponds to the algorithm building in charge of the creation of the building typologies using the information of the public available EPCs in a province. The second part is the application of these typologies in one specific location (municipality) in order to estimate the values for the demand, consumption, primary energy consumption and CO₂ emissions for each building of this location.

For the purposes of the part of the typologies generation, two main data sources were used. On the one hand,

Energy Performance Certificates data from the *Ente Regional de la Energía de Castilla y León* (EREN) through the general open data service from the *Junta de Castilla y León* [5] were acquired, and on the other hand, the other set of data (building data, address, etc.) to be combined came from the Spanish Cadastre [6].

The module's objective is to obtain a combination of both data sources and obtain useful statistics about the energy indicators based on the establishment of typologies based on the use of the building and other parameters such as the climate zone and the year of construction; and also location references for these registers in order to manipulate the data into GIS applications and services.

One of the main reasons to get these data is to try to minimize the effect of the suppositions usually made by other works that rely strongly on simulations or aggregated values [7] (e.g., the aggregations based on the age of the buildings that would not take into account reforms and refurbishment procedures). Thanks to these values, the individual results will be concretely located and the real features of the buildings will be consequently assembled into GIS tools with data derived from EPCs values and not the result of calculated estimations that could not be necessarily accurate.

For the second part of the tool, the estimation of the demanded and consumed energy in one location, the sources of the module are the Spanish cadastre and data about Land Use of Spain (*SIOSE, Sistema de Ocupación del Suelo de España*) [8] a part of the information of the typologies generated. The data from the cadastre are used not only for doing the calculations but also for establishing the location of the building.

The information collected from SIOSE is used in order to complement the information of the current use obtained from the Cadastre.

It is critical to notice that the whole sets of data are publicly available and there are no privacy issues. Otherwise, the procedures should include aggregation procedures to anonymize, like used in [9]

As a summary, all these processes, considering the validation levels for EPCs indicated in [10] will perform validations of levels 0, 1 and 5.

2.1. Typologies generation tool

The main workflow of the tool for the generation of the typologies can be seen in the following figure. The six main phases indicated in the figure are described below.

Phase 1: data setup.

During the initial phase, the goal is to acquire an environment of data files that could help to configure the requests to the cadastre, keeping in mind that these requests represent the largest bottleneck and the most sensitive part of the process.

To aid in our goal of a proper configuration of the requests, some data are necessary:

- **PROVINCES (code list).** Each and every province of Spain has a distinctive code that has to be gathered in order to make a proper

consultation in the cadastre website. The list itself is requested to the cadastre, and a JSON file [11] with the data is recovered and put into the root folder of the application, as long as it will belong to all the consultations. The decision to work with JSON format was taken because a) the format is considered as a valid standard of data and b) the way it is constructed mimics the behaviour of the objects in object-oriented programming that facilitates handling them in languages such as the JavaScript being used.

- **MUNICIPALITIES (code list).** For a single selected province (excluded Basque Country and Navarre because they have their own cadastre system), a data request is performed to get the code values for each municipality in the province. The format of the data is JSON, and amongst other values, the cadastre code number is obtained. The list is put inside a dedicated folder for the province.

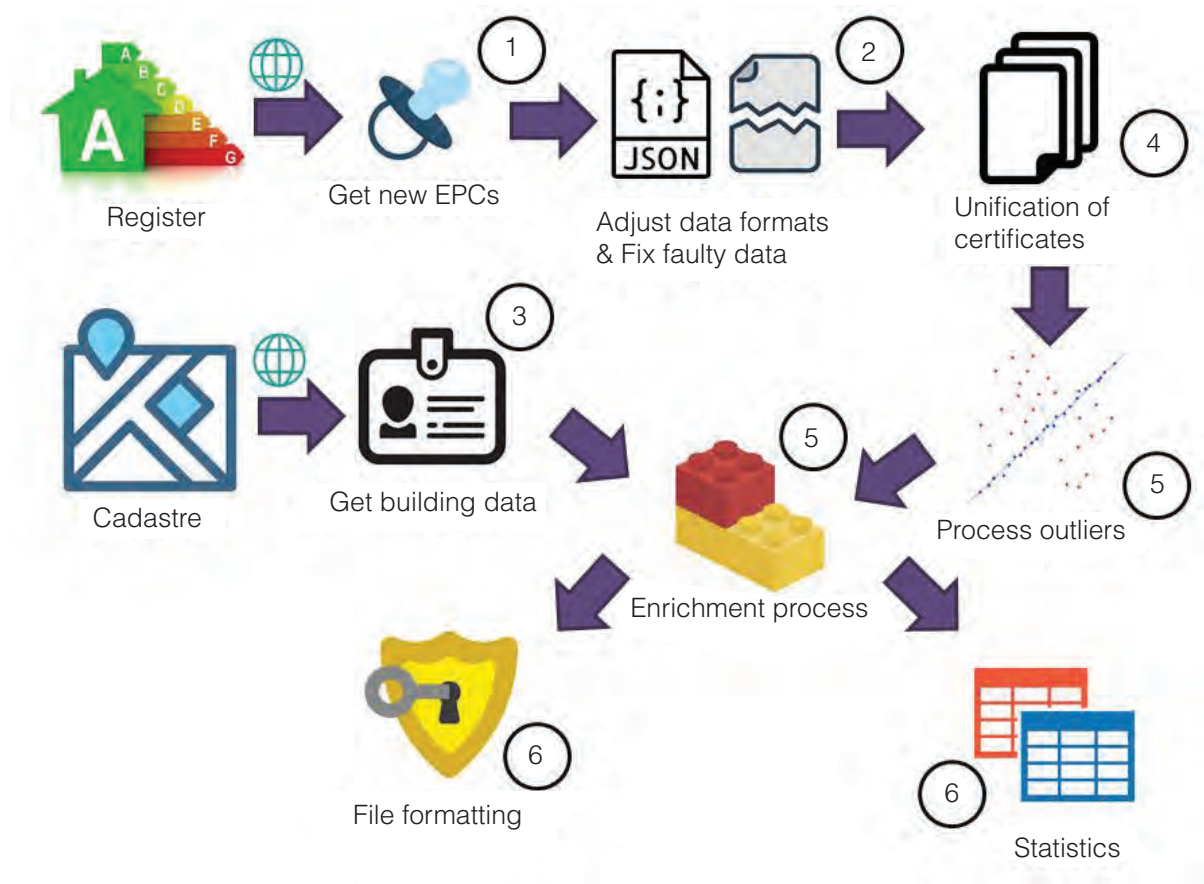

Figure 1: Working flow of the tool developed for the data process

- **STREETS (code list).** For each municipality, a file with the streets codes is downloaded from the cadastre. Everything is inserted into a folder organized like a tree so the files can be easily found.

Phase 2: energy performance certificates acquisition and processing.

The block of data related to energy performance certificates (EPCs) can be also requested via web to a service of open data provided by the Junta de Castilla y León. In Spain, EPC registers are managed at regional level; thus different approaches and data availability may vary from region to region. In other regions there could be similar services that provide the lists with the energy performance certifications necessary for this work, so the module that manages the connection should be adapted.

The system distinguishes between the first instalment and the following ones. First, all the existing certificates are obtained. For the following instalments, only new EPCs need to be processed. However, the system will obtain the full set, so it will have to filter these new ones, thanks to the identification code that the certificates bear.

The next step is to generate the list of objects that will contain the interesting data from the certificates. Most of the variables have a relation one-to-one from the certificates to the destination objects, but some of them need some processing in order to be of use afterwards, concretely, the addresses of the dwellings. The system implemented takes into consideration the habitual layout of the addresses inside the certificates (type of street, name of the street, number, stair/letter/others and postal code in the end) and tries to cope with certain cases and exceptions (suffix in the names of the roads, problems with the codifications, former urban entities absorbed by nearby larger municipalities, etc.). The architecture of this process is purely rule-based, although an alternative considering one customized machine learning tool is proposed as a future development, for example through the usage of TensorFlow [12] or similar software. For that case, the previous experience with the current system will be invaluable to get an initial set of training and evaluation data.

Along with the process of the certification data, the codes referred to the street, the municipality and province are inserted from the code lists obtained during the Phase 1. If there are no coincidences, error fields are filled with the corresponding explanation.

Phase 3: Cadastre identifiers.

The next field to be completed is the cadastre identifier (or Inspire ID) from the element whose energy performance certificate is referred. The quantity of items in use during the latest tests was as large as 30,000 EPCs entries for the province of Valladolid. The system sends one request per object and the cadastre online answers affirmatively or gives off an error message. During this process, the objects containing the information are split into three different groups: (1) elements processed correctly and that now have their corresponding cadastre id, (2) elements containing some kind of error that have been rejected, and (3) a disappeared category containing some cases that never had a proper answer from the cadastre server. The procedure was performed this way in order to minimize the effect of eventual connection failures to the cadastre, considering that online requests are usually one of the weakest parts from a given process, where there is little to no control for the answers, as long as they are strongly asynchronous and prone to have a large range of different failures. Moreover, the cadastre site in Spain has a protection system against Distributed Denial of Service (DDoS) attacks [13] that forced to limit the number of request per hour in order to avoid being banned/blocked. The key to avoid these problems was to allow some asynchronous behaviour with the connections and the processing of the data request by the means of splitting the code into synchronous/asynchronous processes so the results could be properly ordered, filtered and evaluated, generating checkpoints that could be easily followed for educational, clarity and debugging purposes as well as enabling portability of code, replicability and rearrangement in the order of certain procedures. The last part of this phase is a procedure to reprocess elements that did not get a response from the cadastre server, in order to have the definitive list of elements that can be further processed or not, looking to avoid data holes and incorrect results. It works the same as the general procedure.

Phase 4: The unification of certificates.

Unification of certificates in order to harmonise the input data was necessary. This is the case of existing dwelling certificates inside a building block, which are not comparable to the results that would have been obtained when considering the whole building. In order to reduce the potential discrepancies found among certificates of different dwellings inside a building, in the

tool's approach there is only a single certification element per building representing the mean of all of them for every parameter (demand, consumption, etc.).

One advantage of this unification is the reduction in the number of certification elements that will also reduce the number of web requests in the next phase.

Phase 5: Data enrichment and outlier selection.

Once again, the cadastre is consulted in order to obtain information about the buildings, using the cadastre identifiers that the certificates already have. In the same way that has been commented before, this is another execution bottleneck, very time-consuming and consequently has to be carefully monitored. For this purpose, a modified version of a module created for a previous project [2] has been used.

In this point the system has data from two different sources: the Energy Performance Certificates (containing information about the use of the building and energy data: demand, consumption and CO₂ emissions) and the cadastre data (surface, number of dwellings, year of construction and location for establishing the climate zone). All the data is combined into a single element that contains the important information in terms of consumption, and it is also well referred with the address, coordinates and identifiers.

One important procedure during this phase is the handling of outliers [14] [15]. The outliers can be treated during this part of the process, although the corresponding module is well prepared to work during previous stages of the process as well. The method for eliminating outliers includes the following steps:

- **Cluster generation:** Separation of values into "use of building" clusters or building typologies as they are used in the Spanish cadastre. The categories taking into account the uses of buildings are the following: complete blocks of dwellings; individual homes in building blocks; detached houses; educational facility; commercial building; administrative facility; health and hospitals; sports facilities; hotels and residences; office buildings; and other tertiary usages. In the case of the periods the classification used by the energy performance certification tool CE3X [16] is used, which correspond to relevant changes in building construction regulation: before 1981, from 1981 to 2007, from 2008 to 2012, from 2013 to 2018 and after 2018. For climate-related data, the National Code for Building Construction

[17] in Spain was queried, since it establishes reference climate zones. In our case, for each province only two or three climates zones will be differentiated.

- **Treating small groups of elements:** the small groups of elements have been discarded, since it could make no sense to search for outliers when the number of elements is small. For this case, the number of 50 has been chosen, but it can be changed in-code.
- **Mean and the standard deviation calculation for each set of values.** The values of \bar{X} and σ are obtained, and for every single element of the set (X_i) the following equation is used:

$$\left| \frac{X_i - \bar{X}}{\sigma} \right| > 2.5 \quad (1)$$

The equation works perfectly for the values considered (energy heating and cooling demand) in the current building cases. The values that satisfy the Equation 1 are considered outliers, and the whole element is separated from the general set of values. As it happened to other discarded elements, there is a variable dedicated to indicate the kind of error in order to follow and evaluate these cases.

Phase 6: Data visualization: graphs, tables and GIS-based

From this point on, the system has available some tools that:

- Generate values of aggregated demand, consumption and CO₂ emissions values from every building typology considered.
- Create files containing the data from the energy objects. The input are these objects in JSON format, and the output is a .csv file that would fit perfectly into a table in a database or can be manipulated with an Excel type application.

The Figure 2 and Table 1 show an example of aggregation obtained with the results extracted from the province of Valladolid (Spain).

2.2. Applying the typologies: estimation tool

In a given location not all buildings have an energy certificate, so if we mapped the data directly from EPCs we would only get values for a few buildings.

The generation of the typologies not only allows to obtain a set of typologies that can help to study the

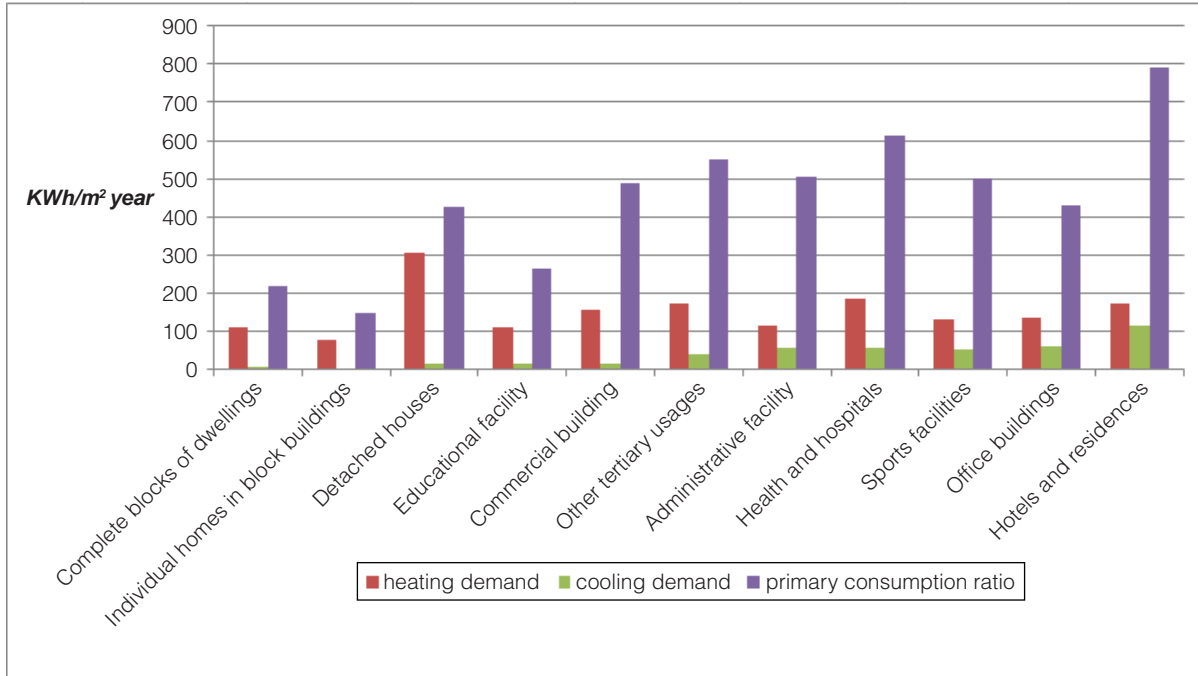

Figure 2: Aggregated values for heating demand, cooling demand and primary energy consumption in kWh/m² per year

Table 1: Example of table of aggregated values for CO₂ emissions per building typology, climate zone and construction period

PERIOD	Climate Zone	Individual dwellings	Residential buildings	Educational facility	Administrative buildings	Health and hospitals	Office buildings	Hotels and residences
before 1981	Y	160.92	40.64	60.60	109.50	134.88	92.25	117,56
1981-2007	Y	82.56	22.50	54.57	121.93	137.62	74,63	283,71
2008-2013	Y	41.34	10.45	88.00	57.00	186.00	122.00	192.00
2014-2018	D	41.14	20.13	0.00	86.00	0.00	0.00	42.00
2014-2018	E	32.80	0.00	0.00	0.00	0.00	0.00	0.00

behaviour of the buildings globally in a province, but also to apply this typologies in one specific location in order to estimate the demand and consumption energy and the emission of the CO₂ of the buildings in this location. The idea is to use the results of the aforementioned process, i.e., the data of demand, consumption and CO₂ aggregated by typology (use, period of construction and climate zone), and to apply them for each building of this location taking into account the use, the year of construction and the climate zone of the building. So an estimation for each building of this location is available regardless of whether or not there is available EPC for that specific building.

Therefore, the estimation based in the application of the typologies on all the buildings can be applied to a

determined municipality in order to determine how that city behaves energetically.

For the application of the typologies we need to know different data from the buildings of the location in order to categorize the building in the correspondent typology and also additional information for the calculations. For this purpose data from the Spanish Cadastre and information about land use from SIOSE is used. So the information extracted from each one is:

1. Spanish Cadastre:
 - a. Location of the building (for locating in a map and for set the climate zone)
 - b. Year of construction
 - c. Condition of the building (in order to discard ruined and declined buildings)



Figure 3: Estimation of the CO₂ emissions in the municipality of Medina del Campo using the tool

- d. Surface of the building
- e. Number of dwellings
- f. Use of the building
- 2. SIOSE:
 - a. Current use of the building (in order to complement the information of the Spanish Cadastre because in the case of the building for the tertiary sector SIOSE has information disaggregated: hotels, office, administrative buildings, educational, etc.)

With this information and with the typologies aforementioned this component of the tool is able to create a map of energy demand, consumption and CO₂ emission in GeoJSON format that can be seen in any GIS tool as QGIS [18].

In Figure 3 it can be seen the result of the tool for the Municipality of Medina del Campo (Valladolid) using in the typologies created for the Valladolid province. The values are in tonnes of CO₂ per year. It is important to highlight that the ruin or declined buildings are considered as zero emissions and besides industrial buildings are not categorised.

3. Layout and working tools

The environment selected in order to deal with the tasks proposed was designed with a high degree of flexibility so the design itself would not condition the goals of the

overall project. The usage of a programming language like JavaScript enables the use of a simple, well developed and full of libraries language, and Node.js was chosen in order to take advantage of a potent set of built-in modules to simplify the inner programming processes, avoiding spending work hours in existing procedures.

Moreover, the JavaScript fits perfectly when dealing with online transactions, and envisioned future implementations, the developed modules could be easily inserted into websites for user interfaces and open platforms.

The last advantage is the portability into Linux/Unix systems, as long as the current production environment is Windows-based, so the solutions would be considered as compatible with as many platforms as possible.

The code was reworked also to avoid the utilization of non-canonical node libraries. When it was possible, the most generic library was put into use. To name some of them, the *fs* library was utilised for file management, the *cron* library for synchronous-timed calls, *http* library for Internet connections or *xlsx* library to generate files compatible with Excel. All these libraries are also public and free of charge.

Most of the testing procedures have been performed with average PCs in order to properly evaluate the performance of the algorithms, especially those that would include data combined with large quanti-

ties of requests that have to be checked one by one, keeping in mind that some external issues would appear and cannot be controlled (e.g., internet connection failures).

4. Assessment of outputs and results

The outputs from the whole process (maps and numerical results) have several applications. The most visual result would be the maps. By interacting with them, a user can appreciate what area of a city is most affected in terms of energy demand, energy consumption, primary energy consumption or CO₂ emissions. This estimation and mapping would not be possible had it not been for the typology analysis performed, as well as the identification of these building typologies using two different data sources. Additionally, the numerical results complement this first output by offering more insight on how the building stock has evolved within a certain typology and enables to aim refurbishment strategies to

a specific set of buildings which are more in need than others. In Table 2 results for some typologies in Valladolid are offered, without discriminating per climate zone. In this case, the reduction in time of different values can be observed in most of the cases. Discrepancies in these values can be used as red flags to highlight typologies which need a more in-depth analysis. It must be stated that the main values to be analysed should be the heating and cooling demand, since energy conversion factors affect the results of primary energy consumption and CO₂ emissions. This can potentially lead to misunderstandings when not being able to relate and compare the results to the fuel used by the energy system in a determined building, since this information is not provided as open data.

In addition to the abovementioned applications, the results obtained can be also used in quality checks performed by the authorities in charge of the Energy Performance Certificates, where a value that deviates from the mean of a determined typology or period may

Table 2: Estimation of values per construction period and building typology

Residential buildings	Before 1981	1981–2007	2008–2013	2013–2018	Health and hospitals	Before 1981	1981–2007	2008–2013	2013–2018
Heating demand	98.47	53.81	28.82	60.69	Heating demand	224.29	174.49	80.94	
Cooling demand	4.77	3.77	3.01	8.82	Cooling demand	31.23	63.68	123.31	
Primary Consumption	189.85	105.55	53.63	102.56	Primary Consumption	596.31	594.35	791.00	
CO ₂ emissions	41.13	22.77	11.21	21.39	CO ₂ emissions	134.88	137.62	186.00	
Individual dwellings	Before 1981	1981–2007	2008–2013	2013–2018	Office buildings	Before 1981	1981–2007	2008–2013	2013–2018
Heating demand	371.64	343.91	108.44	133.45	Heating demand	106.23	124.61	195.39	
Cooling demand	11.90	16.76	8.82	15.10	Cooling demand	53.63	37.81	90.95	
Primary Consumption	691.61	368.34	188.37	199.90	Primary Consumption	399.17	314.13	586.50	
CO ₂ emissions	160.92	82.56	41.34	41.14	CO ₂ emissions	92.25	74.63	122.00	
Educational facility	Before 1981	1981–2007	2008–2013	2013–2018	Hotels and residences	Before 1981	1981–2007	2008–2013	2013–2018
Heating demand	127.25	89.42	112.19		Heating demand	255.53	91.46	138.72	62.28
Cooling demand	13.31	14.19	44.71		Cooling demand	29.39	213.68	66.76	219.2
Primary Consumption	286.14	234.64	384.00		Primary Consumption	516.89	1219.71	838.00	246
CO ₂ emissions	60.60	54.57	88.00		CO ₂ emissions	117.56	283.71	192.00	42

imply that the energy performance certificate might need to be revised.

Future evolutions of the tool would be utilized in solutions with larger scope (region-country-world) in order to aggregate energy-related data from various sources (local and global) and the integration with current GIS software (through the usage of GeoJSON or cityGML files, for example).

5. Conclusions

The paper has presented the development and demonstration of a software tool that generates aggregated data from Energy Certificates and Cadastre values, and has some outputs that will be very useful to integrate in GIS energy analysis processes at urban level, as well as for data analysis based on the typology generation.

Acknowledgements

The TEC4ENERPLAN project is currently financed by the ICE, Instituto de Competitividad Empresarial from Junta de Castilla y León with reference CCTT1/17/VA/0001, co-funded with European Union ERDF funds (European Regional Development Fund).

This article was invited and accepted for publication in the EERA Joint Programme on Smart Cities' Special issue on *Tools, technologies and systems integration for the Smart and Sustainable Cities to come* [19].

References

- [1] Estimated Total Annual Building Energy Consumption at the Block and Lot Level for NYC: <http://qsel.columbia.edu/nycenergy/> [retrieved: Nov, 2018]
- [2] Hernández Moral, G., et.al. ENERGIS: Tool For Demand Characterisation In Urban Settings To Support Energy Planning At Different Scales. 54th ISOCARP Congress 2018.
- [3] Energy Services Platform ENERSI (Plataforma de servicios energéticos basados en la integración y análisis de datos de múltiples fuentes): <http://enersi.es/> [retrieved: Nov, 2018]
- [4] Energie Label Atlas (Netherlands): <http://energielabelatlas.nl/#> [retrieved: April, 2018]
- [5] Datos Abiertos de Castilla y León. <https://datosabiertos.jcyl.es/web/es/datos-abiertos-castilla-leon.html>
- [6] Sede Electrónica del Catastro. <https://www.sedecatastro.gob.es/>
- [7] X. Oregi et al., Automatised and georeferenced energy assessment of an Antwerp district based on cadastral data. *Energy and Buildings*, Volume 173, 2018, Pages 176-194, ISSN 0378-7788, <https://www.sciencedirect.com/science/article/pii/S0378778817340318>
- [8] Sistema de Información de Ocupación del Suelo de España. <https://www.siose.es/ECMA>. Standard ECMA-404. The JSON Data Interchange Syntax. Second Edition. December (2017).
- [9] Dochev I, Seller H, Peters I. Spatial aggregation and visualisation of urban heat demand using graph theory. *Int J Sustain Energy Plan Manag* 2019;24. <http://doi.org/10.5278/ijsepm.3346>.
- [10] Pasichnyi, Oleksii & Wallin, Jörgen & Levihn, Fabian & Shahrokni, Hossein & Kordas, Olga, 2019. "Energy performance certificates — New opportunities for data-enabled urban energy policy instruments?," *Energy Policy*, Elsevier, vol. 127(C), pages 486-499. <https://ideas.repec.org/a/eee/enepol/v127y2019icp486-499.html>
- [11] ECMA. Standard ECMA-404. The JSON Data Interchange Syntax. Second Edition. December (2017). <https://www.ecma-international.org/publications/standards/Ecma-404.htm>
- [12] Open-source machine learning platform by Google. <https://www.tensorflow.org/>
- [13] Mirkovic J., Reiher P., "A taxonomy of DDoS attack and DDoS defense mechanisms." *ACM SIGCOMM Computer Communication Review*. Volume 34 Issue 2, April 2004 P. 39–53. https://link.springer.com/chapter/10.1007/978-3-642-11207-2_17
- [14] Aguinis, Herman & Gottfredson, Ryan & Joo, Harry. (2013). Best-Practice Recommendations for Defining, Identifying, and Handling Outliers. *Organizational Research Methods*. 16. 270--301. 10.1177/1094428112470848. <https://journals.sagepub.com/doi/abs/10.1177/1094428112470848?journalCode=orma>
- [15] Osborne J.W. and Overbay A. The power of outliers (and why researchers should always check for them). North Carolina State University. Practical Assessment, Research and Evaluation. Volume 9, Number 6, March, 2004. <https://pareonline.net/getvn.asp?v=9&n=6>
- [16] Sanctioned document for Energy Certification of Existing Buildings. Developed by CENER & EFINOVATIC. <https://www.efinova.es/CE3X>
- [17] Spanish National Building Code, on Energy Savings (CTE) DB HE: Ahorro de la Energía: <https://www.codigotecnico.org/images/stories/pdf/ahorroEnergia/DBHE.pdf> [retrieved: Nov 2018]
- [18] Free and Open Source Geographic Information System. <https://qgis.org/en/site/>
- [19] Østergaard PA, Maestosi PC. Tools, technologies and systems integration for the Smart and Sustainable Cities to come. *Int J Sustain Energy Plan Manag* 2019;24. <http://doi.org/10.5278/ijsepm.3450>



International Journal of Sustainable Energy Planning and Management

RESEARCH and EXPERIMENTATION

Decision support system for smart urban management: resilience against natural phenomena and aerial environmental assessment

Sergio Taraglio^{a,*}, Stefano Chiesa^a, Luigi La Porta^a, Maurizio Pollino^a, Marco Verdecchia^b, Barbara Tomassetti^c, Valentina Colaiuda^c and Annalina Lombardi^c

^aENEA, Smart Energy Division, Via Anguillarese 301, Rome, Italy

^bPhysical and Chemical Sciences Dept., L'Aquila University, Via Vetoio 42, Coppito (AQ), Italy

^cCETEMPS, Center of Excellence, University of L'Aquila, Italy

ABSTRACT

A new concept of Decision Support System (DSS) is presented. It is able to account for and support all phases of the risk analysis process: event forecast, prediction of reliable and accurate damage scenarios, estimate of their impact on Critical Infrastructures (CI), estimate of the possible consequences. It also provides an estimate of the consequences in terms of service degradation and of impact on citizens, on urban area and on production activities, essential for the mitigation of the adverse events. It can be used in two different modes, either in an operational mode (on a 24/7 basis) or in a simulation mode to produce risk analysis, setting up synthetic natural hazards and assessing the resulting chain of events (damages, impacts and consequences). Among the various possible external data sources an aerial, drone based one is presented. The system may capture both thermal and visual images of CI, processing them into 3D models or collect chemical pollutants concentrations for the monitoring of dangerous air quality due to catastrophic events such as volcano eruptions or large fires. The obtained models and the chemical data can be easily displayed within the framework of the DSS.

Keywords:

Decision support systems;
Structure from motion;
Resilience;
Natural hazards;

URL: <http://doi.org/10.5278/ijsepm.3338>

1. Introduction

Decision Support Systems (DSS) are complex technological tools, which enable an accurate and complete scenario awareness, by integrating data from both the surrounding environment and the behaviour and functional state of the technological systems, in a way similar to [1]. One of the aims is to produce a scenario analysis and to identify the most efficient strategies to cope with possible crises. In the domain of Critical Infrastructures (CI) protection [2, 3], DSS can be used to support strategy elaboration from CI operators, to improve emergency capabilities and to support preparedness actions [4]. The set of CI constitutes an enabling pillar of societal life in an urban area [5], it

guarantees the supply of vital services (e.g. electric distribution, water supply, etc.) thus concurring to citizens well-being. CI are complex technological systems, vulnerable as exposed to natural and anthropic-related events. Physical damages inflicted to CI might produce severe repercussions on their functionality reducing (or even annihilating) it [6]. Moreover, CI outages might produce environmental damages that further worsen the consequences.

DSS could have a critical role in assessing the risk of CI and in enabling asset managers to perform scenario analysis aiming to: i) compare repair/reconstruction strategies; ii) assess risks to mitigate impacts; iii) support the business case for investing into resilience.

*Corresponding author - e-mail: sergio.taraglio@enea.it

Acknowledgement of value

Areti is one of the main Italian electric operators, with about 10 TWh of electricity distributed in Rome, where it manages the electricity grid serving over 1.6 million delivery points. According to our experience and know-how, the applications described in the present paper can be very useful, especially in order to improve the procedures and the processes related to planning and maintenance, and aiming at a prompt and effective risk-based management of the electric network. Moreover, taking into account the increasing demand in terms of service continuity, the applications proposed allow to deal with various issue, such as the stringent requirements arising in complex contexts (e.g. a metropolitan area like Rome). Another added value, compared to similar applications, is the capability to integrate different (interdependent) assets in relationship to the electric system.

Dr. Eng. Silvio Alessandrini, Head of Automation and Innovation Technologies for the Network - Areti (Acea)

The international literature describes several efforts towards the creation of software frameworks for the assessment of risk of CI networks [7, 8]. In most cases the efforts were not directed toward the creation of a user-friendly and ready available DSS to be used by asset managers and local authorities. The American Lifeline Alliance [9] defined guidelines and accompanying commentaries to provide a multilevel process to assess the performance of CI systems in natural hazards and human threat events. In Europe, the EU-funded SYNERG-G project, developed an integrated methodology and a software tool, referred to as OOFIMS Object-Oriented Framework for Infrastructure Modelling and Simulation for the systemic seismic vulnerability and risk assessment of complex systems [10].

One of the main differences with similar applications or platforms, is that the here described DSS has been conceived and developed for a multi-hazard risk analysis (earthquake, flooding, extreme weather, etc.), implementing both a real time operational mode (24/7 monitoring) and a simulation mode (e.g. stress-test analysis). Existing DSS are usually specialised for a single hazard type and/or for a specific operational mode (real time or simulation).

The set-up and implementation of new applications is a crucial initiative. There is an ever-growing belief that prediction and proper preparation to face adverse events can actually produce substantial benefits. This is the spur at the basis of a complex DSS as the CIPCast, here described. A comprehensive worldwide overview of similar approaches, systems and platforms can be found in [11].

The CIPCast is a new concept of DSS [12], which is able to account for and support all phases of the risk analysis process: event forecast, prediction of accurate

damage scenarios, estimate of the impact that expected damages could have on CI service and estimate of the possible consequences. A DSS should also support the identification and definition of preparedness and emergency strategies that could be adopted to reduce the impact, speed-up the mitigation and healing procedures, ease the recovery phase, thus reducing the extent, the severity and the duration of the crisis. A preliminary implementation of such issues has been successfully performed, by developing a specific CIPCast tool (RecSIM), which can be used as effective simulator to perform comprehensive *stress tests* [13].

Besides, the use of aerial systems for the collection of thermal, visual and chemical data can be a useful source of knowledge for several aspects of the scenario. The visual and thermal data can be helpful for the monitoring of CI, also through the 3D modeling of the infrastructure [14, 15], before crisis, for early warning, e.g. for the individuation of electrical problems in power substations. The environmental monitoring in terms of chemical pollutants can be valuable for the modeling of chemicals or particulate matter diffusion during crises such as large fires or volcano eruptions.

In section 2 the CIPCast system is described in detail highlighting the capabilities and features of the system, in section 3 the problem of resilience of CI against natural phenomena such as heavy weather is outlined and two operative examples of the use of the system given. In section 4 an example of data collection is described in two possible scenarios, the elaboration of image sequences into 3D models to be stored and displayed in the DSS for the monitoring of CI in normal conditions and the use of chemical data to compute possible scenarios of particulate diffusion, in the last section some conclusions are drawn.

2. Methodology and CIPCast in general

The CIPCast was conceived as a combination of free/open source software environments including GIS features (GFOSS) [16, 17]. GIS technologies, among other applications see e.g. [18] in this issue, are suitable for supporting risk assessment and emergency management tasks in case of natural hazardous events [19], multi-source data and GIS analysis provide fundamental information for immediate response [20]. The CIPCast DSS is capable of providing a user-friendly geographical interface, by means of a specific WebGIS application, for querying and analysing data and thematic maps, produce and evaluate scenarios, etc., based on specific GIS and SDI (Spatial Data Infrastructures) architectures, developed using GFOSS packages.

On the basis of the knowledge of the location of the CI elements, CIPCast produces an expected damage scenario by assessing the possible degree of damage, depending on the type of event expected (and its intensity), and the specific vulnerabilities of each individual infrastructure element. In addition it evaluates the impact that the computed damage(s) will cause on the infrastructure as a whole and on other infrastructures functionally linked to the one directly affected (through the so-called “domino effect”). Thus it provides an estimate of the consequences over the urban area, in terms of service degradation [21].

Figure 1 shows the main functional blocks of CIPCast and the relevant components. The platform gets external

data from many different sources (e.g. meteo/hydrological models), to establish the current conditions. Then, estimating the expected strength of events, it elaborates a damage scenario, by correlating the strength with the vulnerability of the different CI elements. Expected damages to CI elements are converted into outages of the service. A final step is devoted to inform and support the response, by allowing testing and comparing different strategies for restoring the service by prioritising repairs and deploying physical resources and technical crews [12].

The logical and physical components of the CIPCast architecture, as well as the data workflow, are depicted in the high-level schema reported in Figure 2.

The WebGIS front-end (Figure 3) allows the users to access the available services and the related data through a web browser. In such a way, the user can use thematic maps, charts and other available results (e.g., scenarios).

CIPCast has been designed and implemented to work both in an *operational* mode (on a 24/7 basis, as an alert system) and also in an *off-line* mode by simulating events. In the latter case, the DSS can be exploited as a *stress tester* enabling to set-up synthetic natural hazards (e.g. earthquakes) and assessing the resulting chain of events [22].

Different steps are necessary for estimating induced damage, functional impacts and consequences for infrastructures,:

1. hazard assessment: acquisition, preprocessing and elaboration of input data;

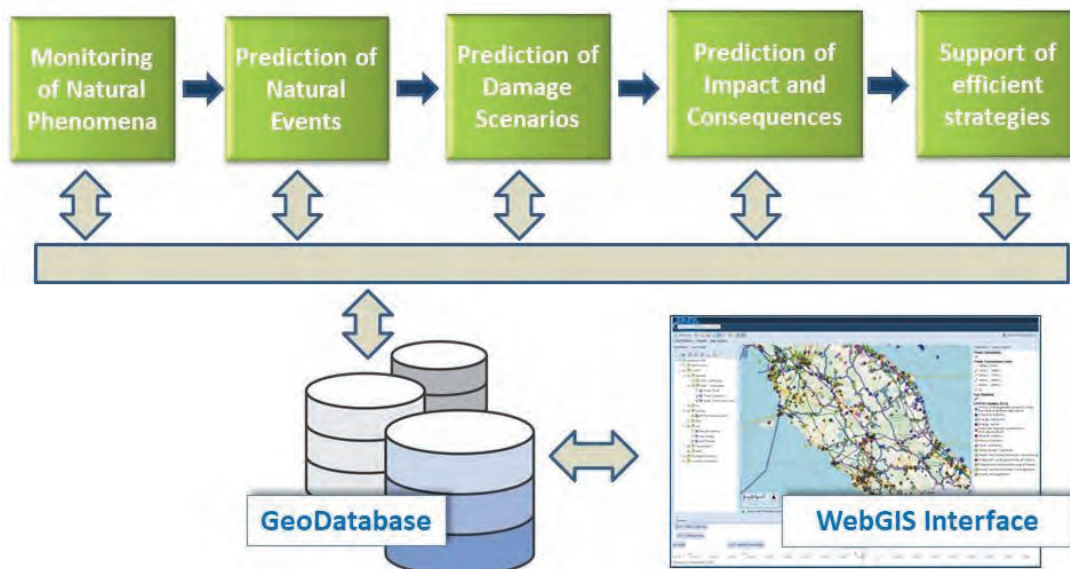

Figure 1: CIPCast workflow and functional blocks [12]

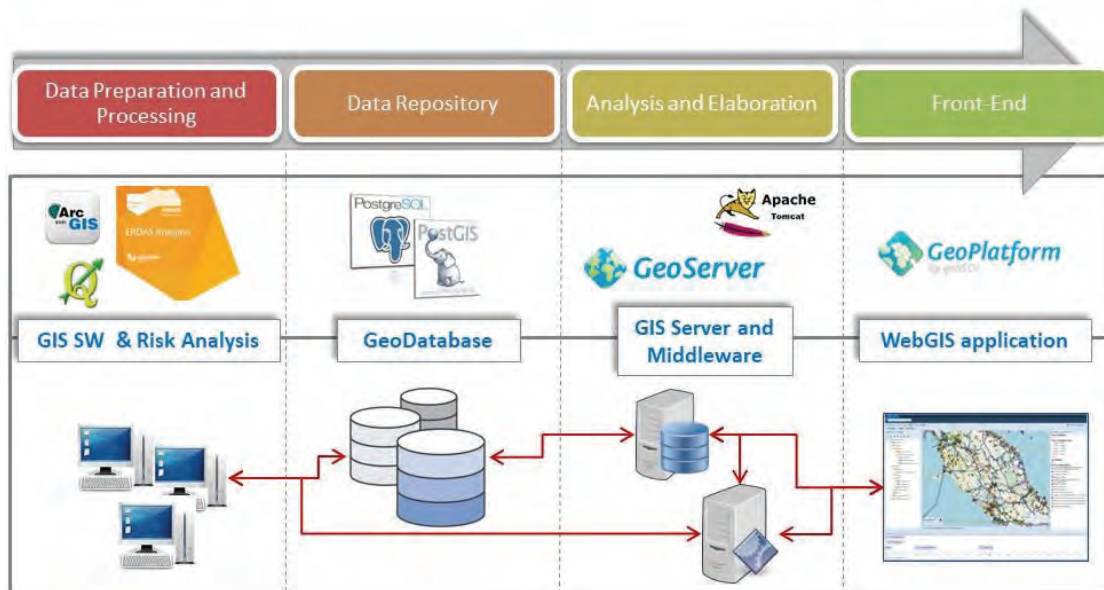

Figure 2: CIPCast architecture high-level schema

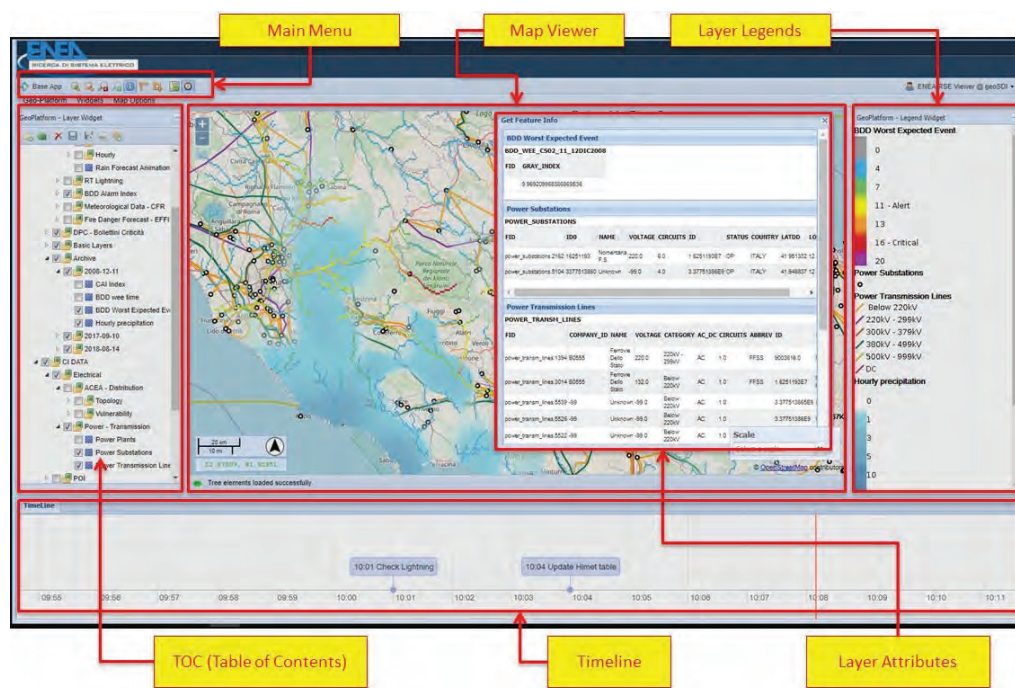

Figure 3: CIPCast WebGIS interface: example of layout

2. classification of infrastructure components;
3. physical damage and functional impact metrics;
4. damage assessment (appropriate hazard-damage relationships);
5. system performance assessment: residual performance of the whole infrastructure;
6. service restoration assessment: repair and service restoration timeframe.

3. Hydrological forecast applied to urban resilience

The Hydrological warning system discussed in this paper is based on the activities carried out with Cetemps Hydrological Model (CHyM). This model has been developed since 2002 in the Cetemps Centre of Excellence of University of L'Aquila with the aim

to provide a suitable and adaptable operational tool for flood alert mapping. CHyM is a physical-based model, all the physical processes contributing to the hydrological cycle are explicitly parametrized. All the variables needed for the hydrological forecast are defined on a regular grid; the typical horizontal resolution for applications over the Italian peninsula ranges from few hundreds of meters to few kilometres. The model has been used in the last years for hydrological simulations both at meteorological [23, 24] and climatic [24] time scale.

Two main features of the model makes it very fitting for the application discussed in this paper: the possibility to run hydrological simulations in any geographical domain with any spatial resolution and the implementation of a native algorithm [26] allowing to ingest and merge on a regular grid, different sets of precipitation data.

A very critical aspect for flood alerting deals with establishing a discharge threshold above which severe hydrological event is expected; of course such threshold level also depends on the specific geomorphological characteristics of each segment of the drainage network. In order to find an efficient numerical approach, a large number of case studies has been simulated and analysed leading to the definition of two different flood alert indexes to map the segment of drainage network where severe hydrological events are expected.

A first index, CHyM Alarm Index (CAI), is an empirical index obtained by the comparison between the total precipitation available for runoff drained by each elementary cell and the cross section of the river channel for the selected cell; the latter quantity being considered a linear function of the total drained area. CAI index is therefore calculated as the ratio between the total drained precipitation and the total drained area; the precipitation is considered in a time interval of n hours, being n the average runoff time for the considered upstream basin.

A further more deterministic alarm index, based on the predicted discharge, is the Best Discharge-based Drainage (BDD). It is defined, for each grid point of the simulated domain, as the ratio between the maximum value of expected discharge in a given time interval and squared of hydraulic radius for the channel contained in the elementary cell; the latter quantity being an estimation of the river cross section in the selected cell.

These indexes have been validated and calibrated during a long operational activity for flood alert mapping carried out for the whole Italy in the last ten years, establishing threshold levels for BDD and CAI above which hydrological stress has to be expected. The final product is a graphical mapping of the drainage network where the segments of the network for which the alarm indexes are above the alarm level are highlighted; see the central panel of Figure 4.

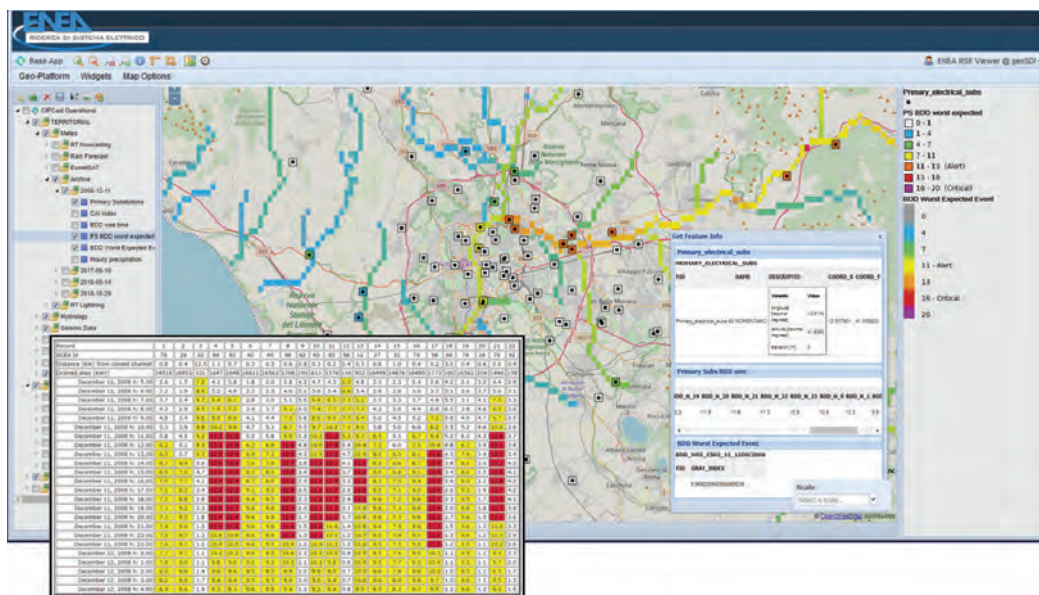

Figure 4: CIPCast WebGIS interface: example of visualization of meteorological forecast (rainfall and flood hazard) overlaid to Electric Distribution Network Primary Substations

For the application described in this paper, the alarm indexes are also specialized to highlight possible critical hydrological stress for each CI element. Basically it is assumed that, for each CI, the main hazard source is represented by the closest channel point within the CHyM grid; the CAI and BDD for that cell are then considered an estimation of stress for that asset. The output consists in a table where, for each CI element, the predicted time series of stress index is given. An example of such tables is reported in the lower panel of Figure 4.

In order to provide to CI operators an objective validation of the proposed alarm system, the operational output has been reproduced for several case studies characterized by severe meteorological events affecting the Tiber basin and the surrounding area in the last years, with different meteorological situations and occurring in different seasons. A summary of these events, for what concerns the total accumulated precipitation, is reported in Figure 5, while the complete list and all the results obtained for each case study are available starting from the URL: <http://cetemps.aquila.infn.it/chym/rse/cs.html>.

Concerning the daily operational activities, CIPCast gathers external data about rain precipitation forecast in a specific area within a specified interval. CHyM model runs simulations every day at about 2 a.m., and makes available all the numerical and graphical outputs in the early morning hours. These simulations cover a period of time that goes from 96 hours before the start of the simulation, up to the following 24 hours. The results are produced both in graphical (NetCDF) and numerical format (data sources, precipitation rates and evolution,

hydrological alarm indices, etc.). Data about forecast precipitation are provided as a sequence of 24 maps covering, with hourly time resolution, the whole *current* day starting from midnight. All files with rainfall data and hydrological indices are then automatically acquired by CIPCast to be exploited by the DSS processes and to be usable through WebGIS interface.

In particular, meteo/hydrological indices are useful to early assess flooding hazard where CI elements are located (Figure 4). Thus, in case of possible hazardous event, the DSS evaluates the damage that the assets (e.g. CI specific elements) are likely to undergo. CIPCast provides an initial damages scenario describing the affected CI components and the damage extent. Estimates can be done either by using historical data or a vulnerability assessment. In such a way, CIPCast, by a tight collaboration with CI operators, can provide impacts on their infrastructures. In addition and in perspective, CIPCast can support all the players involved in the operations, from CI operators to Civil Protection, in order to allow them to have a coherent set on information on which they could properly elaborate mitigation or maintenance strategies and, whenever the case, emergency plans.

As an example of DSS usage, two different applicative cases are described below.

In the first case, an a-posteriori simulation of an extreme weather event striking the electric distribution network was carried out, in order to produce an expected damage scenario and check it against the actual event outcome. This has also allowed to calibrate the hydrological alarm indices (CAI and BDD) and properly define the thresholds. To this end, the CAI and BDD

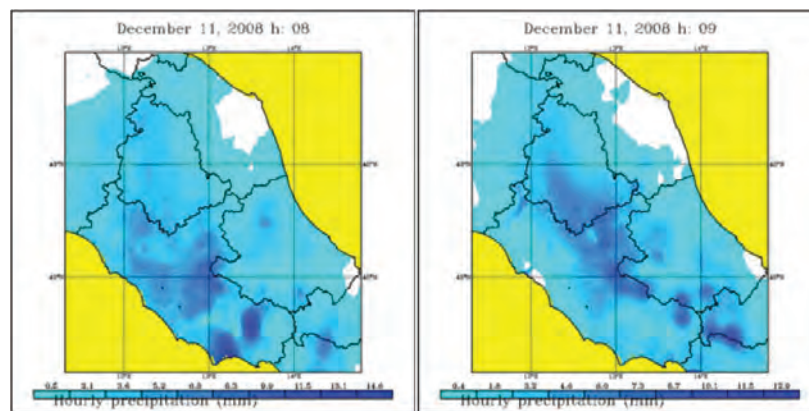

Figure 5: Summary of the total accumulated precipitation for the case studies of December 11, 2008 (left), and December 11–12, 2008 (right)

have been specialised to a set of specific sites that Areti (the branch of ACEA Spa holding, which manages the electric distribution network in the area of Rome) considers as relevant and strategic for the robustness of the electric grid and the services continuity. The alert levels and thresholds were calibrated and validated by simulating a severe event, selected from those that in recent years (2008–2014) affected the area of interest. Hydrological alarm indices were spatially correlated to the location of specific Areti assets (e.g. Primary Substations, PS, of Medium Voltage, MT, network, Figure 4), which are critical elements as they represent the interface between transmission and distribution grids. Possible expected alerts, are highlighted in the table of Figure 4, in yellow or red colour, indicating when CAI/BDD thresholds are expected to be exceeded, impacting the PS monitored (represented with black dots in the DSS GIS interface).

The second applicative case is related to the exploitation of the DSS in real time operational mode, during a different extreme weather event, occurred in fall 2018, when the DSS was actually running. The DSS capability to manage the scenario elaboration and the alarm dispatching towards the CI operator (i.e. Areti) was tested. From the post-analysis, has emerged how the approach was effective for real time operational purposes. In particular, BDD and CAI indices have exceeded their thresholds (indicating a potential critical situation) in correspondence of areas where hydrological criticality actually occurred.

In both cases, the results obtained has shown how the DSS has been able to predict the expected scenario, providing early alerts and highlighting the segments of the drainage network that may represent situations of possible hydrological or hydraulic risk on specific electric grid elements.

4. Data collection

As described in section 1, the DSS can be easily interfaced with several genres of data producers e.g. weather forecasts, infrastructure locations, etc.. In the following, as an example, is presented an aerial monitoring data producer. This system can perform two different tasks: either the thermal and image assessment of buildings, or the measurement of the levels of some air pollutants. From the point of view of the DSS, the first activity may be useful for the monitoring of CI for early warning, while the second can yield measurements for the

modeling of chemicals or particulate matter in fires or volcano eruptions.

The aerial system is conceived as a portable and easily deployed one used for local monitoring, the locality of the produced data is a direct consequence of the legal aspects subtended to the use of remotely piloted aerial systems (RPAS) [27]. The pilot is obliged to have the drone in line of sight, prohibiting any kind of vehicle autonomy and limiting *de facto* the geographical extension of the collected data.

The heterogeneous data collected by the RPAS are to be furnished to the DSS in order to have it easily available for the user. The amount of data in the first case is quite large being composed of thermal and HD images and videos, thus a data processing pipe has been set up to reduce the data to a more compact description. The resulting representations are two 3D models, fusing the images in a single entity: a visible spectrum 3D model for the structural analysis of the building and a infrared one to check for its thermal signature. On the side of the chemical monitoring the data are not processed being a series of records arranged in a limited number of real values and their georeferentiation.

Structure from motion

The algorithms of the structure from motion (SFM) family belong to the photogrammetry science, which performs measurements from images, typically from airborne cameras [28]. SFM is a technique used to estimate 3D structures from a sequence of 2D images either collected by a single moving camera or by a set of cameras from different points of view. The key point of these algorithms is the triangulation of corresponding points across different images. This approach is computing intensive and has found a recent success with the introduction of powerful processing units such as the graphical ones (GPUs).

A paramount importance resides in the algorithm used to extract candidate points from images, the method mostly used is the scale invariant feature transform (SIFT). It uses a vector of image features which are invariant to translation, rotation and scaling and partially invariant to illumination changes, which are then matched against those coming from the other images in terms of Euclidean distance [29, 30].

Once that the correspondences are found, it is possible to compute the so-called fundamental matrix, i.e. the transformation from the point of view of the camera in one image to the one in a different image and thus the

3D content of the scene. If there are more than two images, the subsequent images are iteratively aligned to the already computed set. This cloud of 3D points is then input to the bundle adjustment algorithm [31]. This is an optimisation operating on a very large number of parameters at the same time, i.e. the camera and 3D point positions, repeated over time in the SFM algorithms. It tries to minimise the total reprojection error.

At the end of the optimisation we end up with a cloud of 3D locations representing the features location; an interpolation is then performed in order to obtain a smooth, hole free surface, usually using Poisson surfaces [32]. The last step is represented by the meshing, i.e. the geometrical description of the surface by use of small triangles and finally its texturisation with the color information of the original images.

At the end of the procedure a model in the form of a PLY file (PoLYgon file format) is obtained. This kind of file can be visualized using most of the 3D visualisation software.

There are several different available SFM softwares that can be used, they can be coarsely divided into commercially available and open source ones. The open source solutions come from academic institutions and are usually difficult to use, but, at the same time, open. The market solutions also come from the academic world but through small spinoff companies, they are usually expensive since are targeted to professional use and are closed. There are several scientific papers comparing the two, e.g. [33], whose conclusions are that the results obtainable both with the academic or the commercial solutions are similar, depending on the single application. Naturally the commercial software is much easier to cope with and furnishes a customer support, but often the academic one is more advanced

on the technological side but with a more complex interaction. A note: at least in one case it has been checked that the names of the temporary files produced by a commercial software are almost indistinguishable from those of an open source one, testifying that the professional solution makes use of the open source one, at least partially.

In this work the chosen open source solutions are represented by MicMac [34] and Colmap [35]. The first has been developed by the ENGS (Ecole Nationale des Sciences Geographiques) and the ING (Institut National dell'information Geographique et forestiere), both French and the second by the ETH (Eidgenössische Technische Hochschule, Zürich) and the University of North Carolina (Chapel Hill). In a nutshell MicMac is more powerful but more difficult to interact with, while colmap is window based and more friendly; the results are more geometrically precise on the MicMac side but at the price of sparseness, while Colmap produces smoother surfaces with less holes, see Figure 6. The software has been uses “as is” except for a mild pre processing of thermal images in order to enhance image sharpness and dynamics for a better effectiveness of the matching.

Display

In the DSS the user should be able to display the resulting 3D models with ease. To this end it has been implemented a HTML web page to visualize the models, that can be invoked directly from the DSS. It is based on three.js [36] a JavaScript library that can work in several browser, able to create and animate 3D graphics in a web page without the use of browser plugins, but only using WebGL a JavaScript API for graphical rendering, working directly in hardware on the client side.

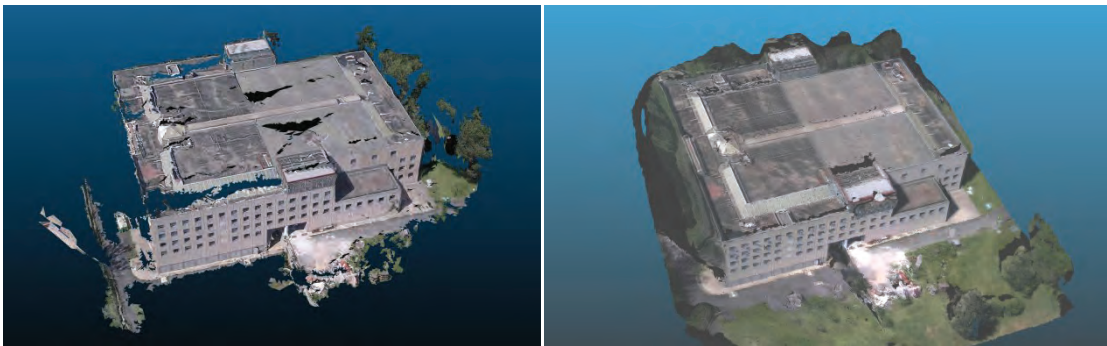

Figure 6: A comparison of MicMac on the left and Colmap on the right

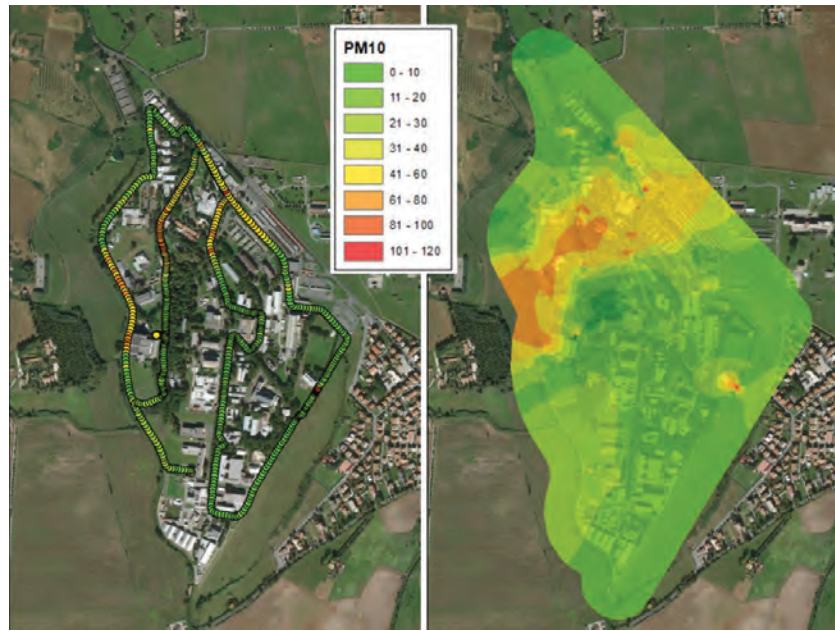

Figure 7: The interpolation of particulate content data (left) by the DSS into a diffusion map (right)

From the side of the chemical measurement, in Figure 7 is shown an example of interplay between the aerial system and the DSS. It can be seen how on the basis of the values of particulate matter (PM10) measured by the system, the DSS may interpolate them to offer a prediction of diffusion in space useful for issuing warnings in the area. Specifically the source of pollution was a bonfire of garden waste and the measurements are the coloured dots on the map.

5. Conclusions

To achieve the goal of creating a user-friendly and ready available DSS to be used by CI asset managers, local authorities and civil protection departments, ENEA has designed and developed (in the frame of EU/Italian-funded projects) a specific DSS platform, namely CIPCast, which enables to operationally perform risk assessment on CI for different kind of natural hazards, allowing to receive external data and to integrate applications enabling data analysis and decision making actions [37]. As an example of external data collection a procedure for the elaboration of image sequences into 3D models and of the processing of chemical pollutant data have been presented. The obtained models can be displayed within the framework of the DSS and exploit the DSS capabilities for data elaboration.

CI operators and managers can take advantage from such new concept of DSS, capable to account for and

support all phases of the risk analysis process: event forecast (when applicable/predictable), prediction of reliable and accurate damage scenarios, estimate of the impact that expected damages could have on CI service (service reduction or loss), estimate of the possible consequences [38].

In perspective, such a kind of DSS will also support the identification and definition of preparedness and emergency strategies that, taking into account the different phases of the expected crisis (event, damage, impact and consequence), could be adopted to reduce the impact, speed-up mitigation and healing procedures, ease the recovery phase, thus reducing as much as possible the extent, the severity and the duration of the crisis.

Acknowledgements

This article was invited and accepted for publication in the EERA Joint Programme on Smart Cities' Special issue on Tools, technologies and systems integration for the Smart and Sustainable Cities to come [39].

This work has been partially supported by the *Ricerca di Sistema Elettrico* (Research on the Electrical System), PAR2015-2018, Project D6 "Development of an integrated model of urban smart district", funded by the Italian Ministry of Economic Development.

The authors wish to thank Dr. Giacomo Cupertino for the flights of the drone used in this work and Dr. Antonio

Di Pietro and Dr. Alberto Tofani for their crucial contribution to the implementation of CIPCast platform.

The authors wish to thank the reviewers for their keen observations which have greatly helped in improving the clarity of the paper.

References

- [1] Heinisch V, Göransson L, Odenberger M, Johansson F. A city optimisation model for investigating energy system flexibility. *Int J Sustain Energy Plan Manag* 2019;24. <http://doi.org/10.5278/ijsepm.3328>
- [2] CIPedia© - Wikipedia-like online community service focusing on Critical Infrastructure Protection (CIP) and Critical Infrastructure Resilience (CIR)-related issues <http://www.cipedia.eu>
- [3] Council Directive 2008/114/EC of 8 December 2008, <http://eur-lex.europa.eu/legal-content/EN/ALL/?uri=celex:32008L0114>
- [4] Rosato, V., Di Pietro, A., La Porta, L., Pollino, M., Tofani, A., Marti, J.R., Romani, C.: A Decision Support System for Emergency Management of Critical Infrastructures Subjected to Natural Hazards. In: *Critical Information Infrastructures Security: 9th International Conference, CRITIS 2014, Limassol, Cyprus, October 13-15, 2014*. pp. 362–367. Springer, Cham (2016), https://doi.org/10.1007/978-3-319-31664-2_37
- [5] Zio, E. Reliability engineering: Old problems and new challenges. *Reliab. Eng. Syst. Saf.* 2009, 94, 125–141, <https://doi.org/10.1016/j.res.2008.06.002>
- [6] Panteli, M., & Mancarella, P. (2017, Sept). Modeling and evaluating the resilience of critical electrical power infrastructure to extreme weather events. *IEEE Systems Journal*, 11 (3), 1733-1742, <https://doi.org/10.1109/jsyst.2015.2389272>
- [7] Ptilakis, K., Franchin, P., Khazai, B., Wenzel, H. (Eds.): *SYNER-G: Systemic Seismic Vulnerability and Risk Assessment of Complex Urban, Utility, Lifeline Systems and Critical Facilities*. Springer Netherlands, 2014, ISBN 978-94-017-8835-9
- [8] GFDRR: *Understanding Risk - Review of Open Source and Open Access Software Packages Available to Quantify Risk from Natural Hazards*. (2015)
- [9] A.L.A. - American Lifelines Alliance: *Guideline for assessing the performance of Electric Power System in Natural Hazard and Human Threat Events*. (2005)
- [10] OOFIMS - Object-Oriented Framework for Infrastructure Modelling and Simulation, <https://sites.google.com/a/uniroma1.it/oofims/>, last access 27/06/19
- [11] Setola R., Luijff E., Theocharidou M. (2016) Critical Infrastructures, Protection and Resilience. In: Setola R., Rosato V., Kyriakides E., Rome E. (eds) *Managing the Complexity of Critical Infrastructures*. Studies in Systems, Decision and Control, vol 90. Springer, Cham, https://doi.org/10.1007/978-3-319-51043-9_1
- [12] Di Pietro A., Lavallo L., La Porta L., Pollino M., Tofani A., Rosato V.: Design of DSS for Supporting Preparedness to and Management of Anomalous Situations in Complex Scenarios. In: Setola, R., Rosato, V., Kyriakides, E., and Rome, E. (eds.) *Managing the Complexity of Critical Infrastructures: A Modelling and Simulation Approach*. pp. 195–232. Springer International Publishing, Cham (2016), https://doi.org/10.1007/978-3-319-51043-9_9
- [13] Di Pietro A., LaPorta L., Lavallo L., Pollino M., Rosato V., Tofani A. (2017) Simulation of Cascading Outages in (Inter)-Dependent Services and Estimate of Their Societal Consequences. In: Havarneau G., Setola R., Nassopoulos H., Wolthusen S. (eds), https://doi.org/10.1007/978-3-319-71368-7_30
- [14] Urquizo J., Calderon C., Philips J. (2019). Modelling the spatial energy diversity in sub-city areas using remote sensors. Published in *International Journal of Sustainable Energy Planning and Management (Vol.22)* <https://doi.org/10.5278/ijsepm.3324>
- [15] Kuriyan K., Shah N. (2019). A combined spatial and technological model for the planning of district energy systems. Published in *International Journal of Sustainable Energy Planning and Management (Vol.21)*, URL: <http://dx.doi.org/10.5278/ijsepm.2019.21.8>
- [16] Steiniger S., Hunter A.J.S., Free and Open Source GIS Software for Building a Spatial Data Infrastructure. In: Bocher E. and Neteler M. (eds.) *Geospatial Free and Open Source Software in the 21st Century*. pp. 247–261. Springer Berlin (2011), https://doi.org/10.1007/978-3-642-10595-1_15
- [17] Pollino M., Modica G.: Free Web Mapping Tools to Characterise Landscape Dynamics and to Favour e-Participation. In: Murgante, B. et al. (ed.) *Computational Science and Its Applications. ICCSA 2013, Part III, LNCS 7973*. pp. 566–581. Springer Berlin (2013), https://doi.org/10.1007/978-3-642-39646-5_41
- [18] Miguel FJ, Hernández-Moral G, Serna-González VI. Supporting tool for multi-scale energetic plan through procedures of data enrichment. *Int J Sustain Energy Plan Manag* 2019;24. <http://doi.org/10.5278/ijsepm.3345>
- [19] Pollino M., Fattoruso G., Della Rocca A.B., La Porta L., Curzio S. Lo, Arolchi A., James V., Pascale C.: An open source GIS system for earthquake early warning and post-event emergency management. In: *Lecture Notes in Computer Science*. pp. 376–391. Springer, Berlin (2011), https://doi.org/10.1007/978-3-642-21887-3_30
- [20] Pollino M., Fattoruso G., La Porta L., Della Rocca A.B., James V.: Collaborative Open Source Geospatial Tools and Maps

- Supporting the Response Planning to Disastrous Earthquake Events. *Futur. Internet.* 4, 451–468 (2012), <https://doi.org/10.3390/fi4020451>
- [21] S. Giovanazzi, M. Pollino, I. Kongar, T. Rossetto, E. Caiaffa, A. Di Pietro, L. La Porta, V. Rosato, A. Tofani: “Towards a decision support tool for assessing, managing and mitigating seismic risk of electric power networks”. ICCSA 2017. *Lecture Notes in Computer Science*, vol 10406. Springer, Cham, 2017, https://doi.org/10.1007/978-3-319-62398-6_28
- [22] L. Matassoni, S. Giovanazzi, M. Pollino, A. Fiaschi, L. La Porta, V. Rosato: “A Geospatial Decision Support Tool for Seismic Risk Management: Florence (Italy) Case Study”. ICCSA 2017. LNCS, vol 10405. Springer, Cham, 2017, https://doi.org/10.1007/978-3-319-62395-5_20
- [23] Tomassetti B., E. Coppola, M. Verdecchia, and G. Visconti, Coupling a distributed grid based hydrological model and MM5 meteorological model for flooding alert mapping, *Adv. Geosci.*, 2, pp. 59–63, 2005, <https://www.adv-geosci.net/2/59/2005/adgeo-2-59-2005.pdf>
- [24] Verdecchia M., E. Coppola, C. Faccani, R. Ferretti, A. Memmo, M. Montopoli, G. Rivolta, T. Paolucci, E. Picciotti, A. Santacasa, B. Tomassetti, G. Visconti and F. S. Marzano, Flood forecast in complex orography coupling distributed hydrometeorological models and in-situ and remote sensing data, *Meteorol. Atmos. Phys.*, 101, pp. 267–285, 2008, <https://doi.org/10.1007/s00703-007-0278-z>
- [25] Coppola E., M. Verdecchia, F. Giorgi, V. Colaiuda, B. Tomassetti, A. Lombardi, Changing hydrological conditions in the Po basin under global warming, *Sci. Total Environ.*, **493**, pp. 1183–1196, 2014, <https://doi.org/10.1016/j.scitotenv.2014.03.003>
- [26] Coppola E., B. Tomassetti, L. Mariotti, M. Verdecchia and G. Visconti, Cellular automata algorithms for drainage network extraction and rainfall data assimilation, *Hydrol. Sci. J.*, 52(3), pp. 579–592, 2007, <https://doi.org/10.1623/hysj.52.3.579>
- [27] https://www.enac.gov.it/ContentManagement/information/N122671512/Regolamento_APR_ed2_em2.pdf, last access 27/06/19.
- [28] https://en.wikipedia.org/wiki/Structure_from_motion, last access 27/06/19.
- [29] Lowe D, Object recognition from local scale-invariant features, in *Proceedings of the International Conference on Computer Vision*, 1999, <https://doi.org/10.1109/ICCV.1999.790410>
- [30] Lowe D, Distinctive image features from scale-invariant keypoints, *International Journal of Computer Vision*, vol. 60, n. 2, 2004, <https://doi.org/10.1023/B:VISI.0000029664.99615.94>
- [31] Triggs B, McLauchlan PF, Hartley RI, Fitzgibbon AW, “Bundle Adjustment - A Modern Synthesis”, *Vision Algorithms '99*, LNCS 1883, pp. 298–372, 2000, Springer, Berlin, https://doi.org/10.1007/3-540-44480-7_21
- [32] Kazhdan M, Bolitho M, Hoppe H, Poisson surface reconstruction, in *Proc of the 4th Eurographics Symp. on Geometry Processing*, 2006, <http://dl.acm.org/citation.cfm?id=1281957.1281965>
- [33] Chiabrando F, Donadio E, Rinaudo F, SfM for orthophoto generation: a winning approach for cultural heritage knowledge, in *The International Archives of the Photogrammetry, Remote Sensing and Spatial Information Sciences*, 25th Intl CIPA Symp 2015, Taipei, Taiwan, 2015, <https://doi.org/10.5194/isprsarchives-XL-5-W7-91-2015>
- [34] Rupnik E, Daakir M, Pierrot-Deseilligny M, MicMac – a free open-source solution for photogrammetry, *Open Geospatial Data, Software and Standards*, vol. 2, n. 14, 2017 <https://doi.org/10.1186/s40965-017-0027-2>
- [35] Colmap Structure-from-Motion and Multi-View-Stereo, [Online]. Available: <http://demuc.de/colmap/>, last access 31/05/19.
- [36] three.js - Javascript 3D library, <http://threejs.org>, last access 27/06/19.
- [37] Tofani A, Di Pietro A, Lavalle L, Pollino M, R. V: Supporting decision makers in crisis management involving interdependent critical infrastructures. In: *The International Emergency Management Society (TIEMS) 2015*. TIEMS, Rome (2015)
- [38] Tofani A. et al.: Operational Resilience Metrics for a Complex Electrical Network. In: D’Agostino G., Scala A. (eds) *Critical Information Infrastructures Security*. CRITIS 2017. LNCS, vol 10707. Springer, Cham (2018), https://doi.org/10.1007/978-3-319-99843-5_6
- [39] Østergaard PA, Maestoso PC. Tools, technologies and systems integration for the Smart and Sustainable Cities to come. *Int J Sustain Energy Plan Manag* 2019;24. <http://doi.org/10.5278/ijsepm.3450>.

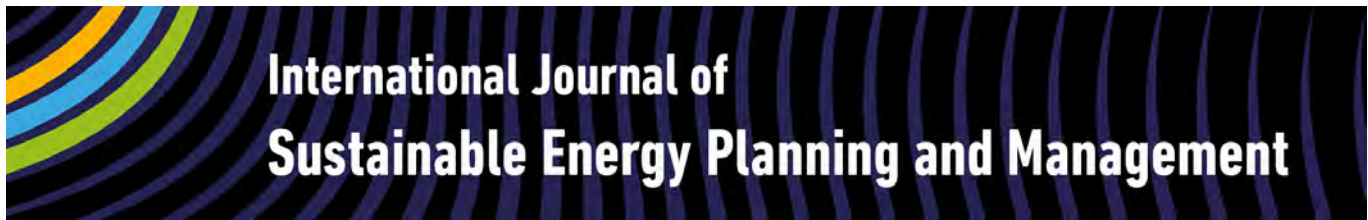

RESEARCH and EXPERIMENTATION

Sustainable energy planning as a co-creative governance challenge. Lessons from the Zero Village Bergen

Savis Gohari^{a,*} and Stig Larssæther^b

^aNorwegian University of Science and Technology, Department of Architecture and Planning

^bNorwegian University of Science and Technology, Department of Energy and Process Engineering

ABSTRACT

Sustainable energy transition implies different, but interlinked strategies, technologies and policies, implying a complex array of overlapping systems that are shaped by diverse actors' interventions. The formal mechanisms of sustainable transition are ill equipped to address and conform with the political-power dimensions. Furthermore, there is no determined blueprint for sustainability transitions and the existing governance systems hitherto have been inefficient and implicated in unsustainability. This paper argues that energy transition requires conceptualization of co-creative governance, and the dynamic interplays between power relations in the face of conflict of interests. Thereby, this paper goes beyond the traditional division of governance network between private, public and academia to investigate the political structure underpinning the functionality of governance. To assess how sustainable energy transitions can be materialized, the aim is to understand how different multilevel governance systems deal with the competing interests, asymmetrical power and mobilization of resources for goal achievement in the case of Zero Village Bergen. The purpose is to shed light on political and institutional challenges that are common to other sustainable transition initiatives. The method used is semi-structured interviews with private and public actors. The findings describe how the latent conflict between different involved actors' interests has led to prolongation, recurring controversies, stagnation, and moments of adaptation.

Keywords:

Sustainability;
Zero-Emission;
Governance;
Planning;
Bergen;

URL: <http://doi.org/10.5278/ijsep.3353>

1. Introduction

The challenge to make a city sustainable is not primarily on technology, but on service transformation and improvement [1, 2]. The latter is beyond the capacities and reaches of the traditional government alone, and innovative form of governance is needed [3]. The governance approach emphasizes the plurality of actors, indicating that there is no single actor, who has enough steering capacity to determine the strategic actions of the other actors [3, 4]. Dependencies between actors create patterns of relations between them, and the inevitable inconsistency between their interests make the processes of bargaining, coalition formation, and conflict mediation imperative. In these processes, many actors may be

forced or convinced to change their original or real attitude and set new goals. Based on their new goals, new networks will be formed, and actors may play new roles. Such loops can be repeated, again and again, until a particular condition is satisfied. Therefore, the outcome of sustainable energy planning is subject to change during the actors' networks' lifecycle in different phases of initiation, emergence and implementation or uptake. On the other hand, the multiplicity of actors and hidden informal exercise of power to protect special interest can exacerbate the political and managerial complexity, ambiguity and uncertainty. This can lead to prolongation, recurring controversies, stagnation, and unwilling adaptations, and challenge transparency, accountability and legitimacy of

*Corresponding author - e-mail: savis.gohari@ntnu.no

Acknowledgement of value

The work presented by Gohari and Larssæther is very interesting as it discusses the obstacles for sustainable transition within a multilevel governance system. The work is extremely relevant and published at the right time, when the ZVB area plan is approved by the government in 2019, and there is much to learn for the future development of Bergen. The application of the multi-actor model of Avelino and Wittmeyers as a useful methodology to detect actors' constellations and their interests and power is extremely relevant for SINTEF, as one of the knowledge communities. The authors' focus on the role of the knowledge community is very enlightening for dealing with other pilot areas within the ZEN Center and beyond that for other areas on national and global scale.

Daniela Baer, researcher, SINTEF, Norway

the planning process. Thus, strengthening the institutional governance is critical for taking cooperative action and for implementation of effective policies. However, there is a lack of empirical studies to investigate the dynamics of governance, and mechanisms of sharing resources, shifting power relations and fostering knowledge flows within sustainability transition [5]. While this paper fills the knowledge gap, it considers the contextual basis of the governance functionality that a specific governance system may embed a distinctly opposite output in another context. Thus, it concentrates on the transformation of governance in a single case of Zero Village Bergen.

2. Theoretical approach

Potts and Vella [6] argued that any analysis of a governance system must consider how it is structured and organized, but also the way in which the structures in the

system function. Analyzing both the 'structures' and 'functions' enables planners to take a more systemic view of decision-making, while still accounting [in a non-linear way] for the numerous dynamic interactions of multiple structures across scales and policy spheres. Governance structure and function are interconnected and affect each other constantly, thereby analyzing the dynamics of transition governance without considering the interconnection between governance structure and function is incomplete [6, 7].

2.1. Governance structure

To illustrate the governance structure, i.e. the way actors stand in a network and interact with each other, this paper adopts Avelino and Wittmayer's [8] Multi-actor Perspective (MaP) which is developed to understand transition politics by focusing on shifting power relations. In this model, (figure 1), the functionality,

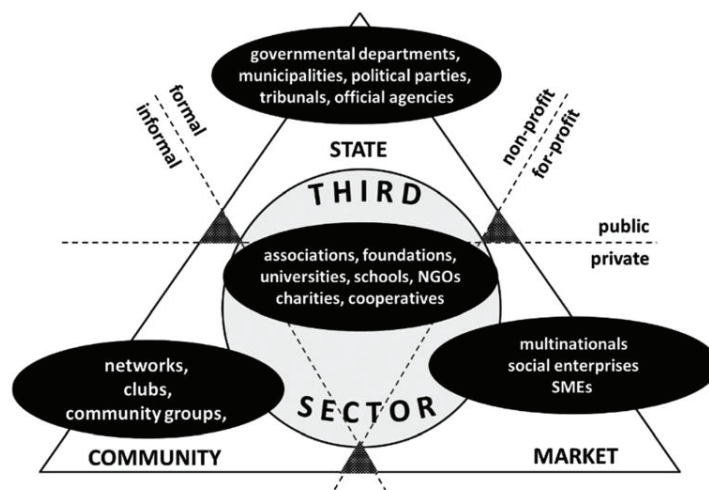

Figure 1: Multi-actor governance structure model [8]



Figure 2: Illustration plan for Zero Village Bergen*

i.e. the actors' interactions are seen along the three axes: (1) informal-formal, (2) for profit-non-profit and (3) public-private. Similar to the quadruple helix, actors are structured in four actor categories; 1. State; 2. Market; 3. Community; 4. Third sector, which universities/academia belong to. A rationale behind the choice of MaP is its deep attention to the role and power of the university as a social entrepreneurial and cooperative organization, conceptualizing an intermediary between the three others [8]. In this model, sectors are not fixed entities, indeed the boundaries between them are contested, blurring, shifting and permeable [8]. In addition, an actor can be a person, organization, or a collective of persons and organizations, which is able to act [8, 9].

A person, who has a legal right to intervene in a process, is thus a stakeholder (e.g. the residents), until he/she takes an action and plays a role to influence the outcome and becomes an actor. Actors and institutions can exist at multiple scales/levels of governance, interconnect with other actors across the system, and fulfill more than one role, due to the existing interdependencies [10]. Accordingly, it is relevant for the transition governance to sustainability to assess who the different

* <http://zerovillage.no/om-prosjektet/andre-forhold/>

actors are, how they exercise their power and the (shifting) power relations between them [8].

2.2. Governance function

The structure and position of each actor at different levels of governance give them some functional attributes that lead to actions that are no longer in the direction of their positional affiliation [10]. The functional governance explains how different components influence and shape actors' actions/decisions over time. Functionality is explained by different levels of connectivity (direct-indirect or formal-informal) and power relations between actors to have access to information, knowledge or other forms of resources. Planning and decision-making in the face of inconsistent interests bring the idea of power into focus [11] and asymmetrical power relations can make the decision-making conflictual [12, p.31]. Accordingly, investigation of transition governance functions requires an understanding of the interaction between all different components, such as interests, power, conflict, roles and resources.

3. Methodology

The main body of empirical materials in this study consists of five qualitative semi-structured interviews and follow-up conversations (on later stages) with seven central actors, involved in the Zero Village Bergen (ZVB) case in autumn 2013. The ZVB is a single case study [13] that does not allow for statistical generalization of findings. However, through seeking out sufficient variability in informants and triangulation of statements it is possible to use analytical generalization to put forward theoretical propositions [13]. ZVB has been a pilot project at the Research Centre on Zero Emission Neighborhoods (ZEN) at the Norwegian University of Science and Technology (NTNU) in Trondheim. This center serves as an innovation hub for co-creation between different stakeholders across sectors, functioning as a lighthouse to develop solutions in real-life contexts to support the development and dissemination of ZEN-related knowledge. The authors are partly connected to the ZEN Centre, but this study is performed independently of this institution and is not formally a part of the research performed under ZEN work packages.

Interviews were taped, transcribed, coded and analyzed by template analysis [14]. To protect the identity of informants, no detailed description of their position and role in the case is disclosed and their quotations are anonymous. However, the authors corrected grammatical

errors, using brackets to protect the original wording. In situations where it was uncertain whether a correction might change the core of an interviewee's content and intended meaning, the errors remained unchanged.

4. Zero Village Bergen (ZVB)

ZVB consists of a new neighborhood on the outskirts of Bergen (16 km south of Bergen city center). The plan includes approximately 720 dwellings (92 000 m²), divided between terraced houses (68% of total floor area) and apartment blocks (25%). 7% of the floor area is dedicated to nonresidential purposes such as offices, shops and a kindergarten. In addition, a common parking garage is planned.

A forest and a lake, as well as a residential area and a road, surround the area. The planned development area is currently in use as a greenfield with some semi-detached houses. The closest public transportation hub is the light rail, 1.5 km to the north, but there is a bus stop on the site with bus frequency approx. every 15 minutes.

Below is a brief summary of the project's progress so far:

- 2009 ZEB (later ZEN) is established - ByBo joined as an industrial partner
- 2010 BYBO/ZEB choose Ådland as a site; Bergen City Council started making an area plan, which faced opposition from County

Governor of Hordaland and Hordaland County Council

- 2013 The Ministry of the Environment approved the area plan with remarks; New prognosis on airport noise pollution challenges the planned development
- 2014 Public hearing demanded further clarification of energy and planning process
- 2016 Revised plan was sent to the County Governor of Hordaland
- 2017 Opposition from the County Governor o was sent to the Ministry of Climate and Environment (MoCE)
- 2018 The Ministry of Climate and Environment upheld the objections from the County Governor
- 2019 The area plan for ZVB was finally approved by the Ministry of Local Government and administration

In this section, we describe how centrally involved actors have experienced selected elements and episodes in a specific moment in the process (late autumn 2013). Figure 3 shows the position of actors in a governance system, based on the model, adapted from Avelino and Wittmeyer [8].

In the early phase of the project in 2009, the most critical issue in ZVB was the site selection, which had to meet the stringent ZEB technical criteria. As a part of this process, ByBo contacted the central decision makers

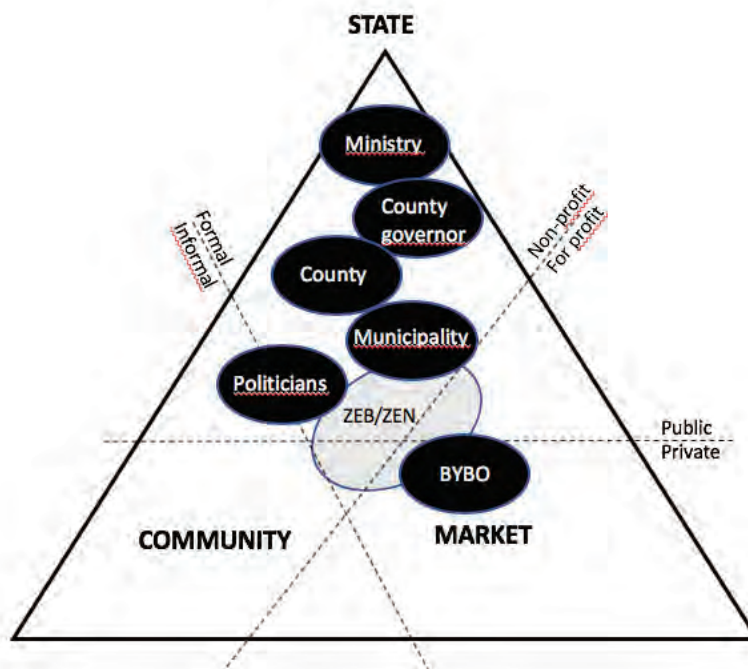

Figure 3: The governance structure Adapted from Avelino and Wittmeyer [8]

in the region and exercised their informal power/influence to gain the essential support for the project. Here in the words of our interviewee in ByBo:

We have tried to influence [the people] to speed up the process, such as the politicians in Bergen, the Chamber of Commerce and the Hordaland bench to represent us in the parliament. We discussed the project with them and gave them the information to gain their support. And we were successful to be heard when we needed it.

In addition, ByBo had to have a more formalized communication with the property division of the municipality to choose a site. In response, the municipality introduced some pre-regulated residential areas. However, the area that BYBO was interested in, i.e. Ådland, was agricultural land not regulated for housing purposes. According to one of the interviewees:

When we evaluated the municipality's suggested properties, we realized that there would be a competitive bidding for them. A public property – needs to be sold in a market (...) In practice, none of the properties were feasible for us.

The choosing of Ådland created a conflict with several public agencies, among which the county governor of Hordaland was the strongest opposer. For the county governor, the choice of Ådland, represented a narrow view, focusing only on reducing footprints of buildings:

The whole idea of city planning has been scrapped and sidelined. [Reducing carbon footprints of buildings] was a very myopic focus and its influence on the whole planning process was ignored- within this small circle. [Reducing carbon footprints of buildings], everything should be done right - As spatial planner - I find this totally ridiculous.

Such a narrow focus on energy emissions was also criticized by other interviewees from the Hordaland County administration:

There was a list of [technical] criteria – [but] who did decide that it should be like this? The site selection was not put forward for public hearing. [the site selection] should usually happen as a part of the municipal planning process that will be weighted according to the other aspects, which requires a large political consensus behind it. But suddenly one can depart from this because of a whole new set of criteria?! We do not have a mandate to do that. However, the politicians can.

One of the interviewees at the municipality administration pointed out the economic dimension in the selection process - where the property owners' price expectations might have played a dominant role:

The owner of the chosen property was willing to sell at a lower price because the current type of land-use was not very profitable. So, the reasonable price of this site might have an influence on the site selection - even though it should not. In my opinion, if a pilot project means putting projects in the cheapest land, then it is not a very good example of spatial planning.

Several interviewees also pointed to a larger political discourse around the planning regime, addressing a seemingly great opposition between politicians and bureaucrats. The role and influence of politicians in this issue attracted criticism from the county, here in the words of one of our interviewees:

It is a culture in Bergen Municipality to work in a way, in which things are done in a straight line and [are handled] directly by the city commissioner, the city council and the city committee.

This is expanded on by a second interviewee from the county:

This is an ingrained culture in Hordaland county, where the politicians do not care about the Plan and Building Act. The Act does not apply there, and it can be disregarded. Planning is just a bureaucratic hassle.

The statements of the interviewees above reflected their perspectives towards the politicians in Bergen Municipality and the private actors, who through informal channels of influence have made the culture/[nature] of the planning process less democratic according to their view. This statement from one of the central politicians involved in the ZVB case shows how this matter was perceived from their position:

It is a widely held opinion that if the politicians in the municipality go against the bureaucrats, we have it coming from the administration of the county governor. Or the administration in the county. I have seen this from people working as politicians on the county level. There are some un-democratic forces where the bureaucracy) tries to go against the publicly elected will.

According to this informant there seem to be informal networks working between the administration on various levels, involving municipal, county level and state level representative at the county governor's office. It is also interesting to note how the most important tool of the administration in the formal planning process - the planning and building act, was perceived by the same politician in the statement below:

The Plan and Building Act is the most anti-democratic and illegitimate tool I have ever come across, which is not in the public interest. It is impossible to fully

grasp the complexity of the Act, and the way it balances the public interests in business and other things, and the way it governs the bureaucracy.

In the unfolding narrative of ZVB, the ZEB/ZEN center has held a central position along several dimensions (see figure 3). ByBo has also actively used its affiliation with the research community to position itself as a frontrunner for low or zero emission buildings, implying their environmental interest and motivation. However, BYBO is also a commercial actor with a clear profit motive/economic interest and these differences in interests, views, and goals of BYBO and ZEB/ZEN have resulted in conflicts with the planning and governmental authorities. The political and legal dependency of ByBo and ZEN on the public authorities for the site selection, has created a great amount of uncertainty for them which complicated the implementation of the planning process.

Both the localization outside regulated areas for housing and neglecting the transportation issues in the initial concept for ZVB has generated great resistance and conflict among public authorities. Thus, the scientifically grounded project framing from ZEN/ZEB played a critical and counterproductive role in the planning process. The strategic use of informal networks also compromised the professional identity and perceptions of “due process” among many public actors.

To understand the dynamics of governance through which the actors acted in this case, it is important to focus on the way in which ByBo has drawn on their social network and bond with the ZEB/ZEN center. ZVB by carrying the status of a pilot project in a long-term and ambitious research center had a much higher chance of receiving political support, than without this label. The linkage with ZEB/ZEN has also empowered and equipped the developers with a series of “greater good” arguments, such as branch-leading ways of addressing climate concerns and, branding Bergen as a climate – friendly and innovative region.

5. Conclusions

This paper has used the multi-actor model of Avelino and Wittmeyers [8] to explore which actors are involved in the transition governance to sustainability, how they exercise power, and what factors explain the (shifting) power relations between them. It should here be noted that in the current stage of the planning process, of ZVB, there has been no direct community involvement, beyond

that of elected politicians. Despite of these limitations, we still see this as an interesting illustration of a quadruple helix innovation system in which the knowledge community plays an active part. In the current wave of smart city initiatives municipalities and universities are increasingly taking part in cross-sectoral partnerships and platforms. The current case study has demonstrated that there is a substantial potential for role conflict here, between public authorities as guardians of the common interest, and the formal and informal bindings that occur when they form alliances with commercial actors who will also seek to pursue their self-interest [15, 16]. It is here important to strike the balance between securing democracy and legitimacy of planning through “due process” and the need for new forms of governance with respect to dealing with pressing energy and climate concerns.

It is, however clear to us that the knowledge community holds the potential of reducing conflict between private and public actors by creating arenas where common narratives can be developed across diverse societal interests over time. In pursuing this role, it is crucial that we combine insights into the paradoxes and dilemmas of real-life cases, being aware that our preconceived expectations about the role of the knowledge sector in unfolding governance processes may be challenged. As a result, instead of considering decisions as resulting from the intention and interests of independent actors, attention should be paid to the interaction patterns and the ways in which individual actors and organizations evolve over time. Reflecting on the multi-actor model from Avelino and Wittmeyer, we see that the temporal dimension of the role of actors is not given the focus it deserves. In this regard, we stress the need for developing governance models that better capture the iterative nature of real-life planning processes.

Acknowledgements:

This article was invited and accepted for publication in the EERA Joint Programme on Smart Cities’ Special issue on Tools, Technologies and Systems integration for the Smart and Sustainable Cities to come [18].

References

- [1] Errichiello, L. and A. Marasco. Open service innovation in smart cities: A framework for exploring innovation networks in

- the development of new city services. in *Advanced Engineering Forum*. 2014. Trans Tech Publication. <https://www.scientific.net/AEF.11.115>.
- [2] Tomc, E. and A.M. Vassallo, Community Renewable Energy Networks in urban contexts: the need for a holistic approach. *International Journal of Sustainable Energy Planning and Management*, 2015. 8: p. 31–42. <https://doi.org/10.5278/ijsepm.2015.8.4>
- [3] Cassinadri E, et al., Sharing Cities: from vision to reality. A people, place and platform approach to implement Milan's Smart City strategy. *International Journal of Sustainable Energy Planning and Management*, 2019. 24. <http://doi.org/10.5278/ijsepm.3336>.
- [4] Healey, P., Planning through debate: the communicative turn in planning theory. *Town planning review*, 1992. 63(2): p. 143. <https://doi.org/10.3828/tpr.63.2.422x602303814821>
- [5] Haarstad, H., Who is driving the 'smart city' agenda? Assessing smartness as a governance strategy for cities in Europe, in *Services and the green economy*. 2016, Springer. p. 199–218. https://doi.org/10.1057/978-1-137-52710-3_9
- [6] Potts, R., et al., Exploring the usefulness of structural–functional approaches to analyse governance of planning systems. *Planning Theory*, 2014. 15(2): p. 162–189. <http://doi.org/10.1177/1473095214553519>.
- [7] Forester, J., *Planning in the Face of Power*. 1989, Berkeley, CA: University of California Press. <http://doi.org/10.1080/01944368208976167>.
- [8] Avelino, F. and J.M. Wittmayer, Shifting power relations in sustainability transitions: a multi-actor perspective. *Journal of Environmental Policy & Planning*, 2016. 18(5): p. 628–649. <http://doi.org/10.1080/1523908X.2015.1112259>.
- [9] Dente, B., Who Decides? Actors and Their Resources, in *Understanding Policy Decisions*. 2014, Springer. p. 29–66. https://doi.org/10.1007/978-3-319-02520-9_2
- [10] Gohari, S., Governance in the planning and decision-making process : the co-location case of university campuses in Trondheim, Norway [2000-2013]. Vol. 2019:74. 2019, Trondheim: Norwegian University of Science and Technology, Faculty of Architecture and Design, Department of Architecture and Planning. https://ntnuopen.ntnu.no/ntnu-xmlui/bitstream/handle/11250/2594244/Gohari,%20Savis_fulltexr.pdf?sequence=5
- [11] March, J.G., *Primer on decision making: How decisions happen*. 1994, New York: Free Press.
- [12] Pierre, J. and B.G. Peters, *Governance, politics and the state*. 2000, London: MacMillan. VIII, 231 s.
- [13] Yin, R.K., *Case study research: Design and methods*. Vol. 5. 2009: sage.
- [14] King, G., *Unifying political methodology : the likelihood theory of statistical inference*. 1998, Cambridge: Cambridge University Press.
- [15] Kitchin, R., Making sense of smart cities: addressing present shortcomings. *Cambridge Journal of Regions, Economy and Society*, 2015. 8(1): p. 131-136. <https://doi.org/10.1093/cjres/rsu027>
- [16] Gabrys, J., Programming environments: environmentality and citizen sensing in the smart city. *Environment and Planning D: Society and Space*, 2014. 32(1): p. 30–48. <https://doi.org/10.1068/d16812>
- [17] Meloni C, et al., Energy sustainability and social empowerment: the case of Centocelle smart community co-creation. *International Journal of Sustainable Energy Planning and Management*, 2019. 24. <http://doi.org/10.5278/ijsepm.3339>
- [18] Østergaard PA, Maestosi PC. Tools, technologies and systems integration for the Smart and Sustainable Cities to come. *Int J Sustain Energy Plan Manag* 2019;24. <http://doi.org/10.5278/ijsepm.3450>

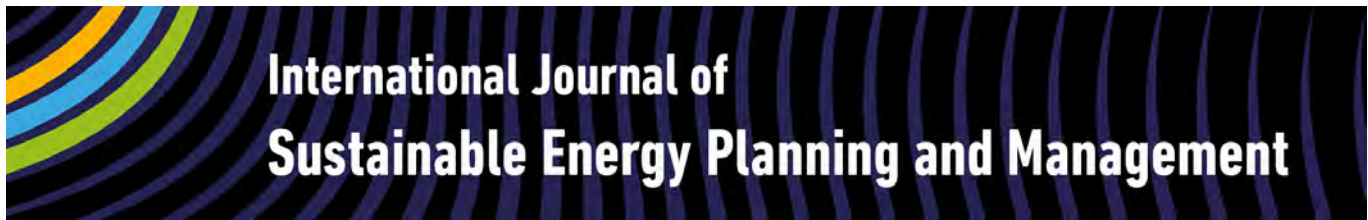

RESEARCH and EXPERIMENTATION

Smart community co-creation: the case of centocelle project

Francesca Cappellaro^a, Roberta Chiarini^b, Claudia Meloni^b and Claudia Snels^b

^a ENEA- SSPT Department for Sustainability, Italian National Agency for New Technologies, Energy and Sustainable Economic Development, C.R. Casaccia, Via Anguillarese 301, 00123 Rome, Italy

^b ENEA-DTE-SEN Energy Department, Italian National Agency for New Technologies, Energy and Sustainable Economic Development, C.R. Casaccia, Via Anguillarese 301, 00123 Rome, Italy

ABSTRACT

Currently, one of major institutional challenges Italy is facing in the field of integrated sustainability is to further develop the local governance capacities in order to facilitate the energy transition; this challenge, which, up to now, was caused by poor adoption of technologies, can be solved through the socio-environmental-energy nexus, through open innovation processes and sharing approach.

This paper examines and describes a series of technological, social, economic and community empowering activities in the Centocelle district of Rome, that have been developed following the Social Urban Network Model.

The paper describes the theoretical basis of the model and the model itself, then it goes on pointing out all the activities in the district such as the establishment of a social-web, smart labs, living labs, circular economy practices and their consequences and impacts on the district itself. As a main result of the social part of the project the authors account for the birth of a new social organization, known as the Community Cooperative of Centocelle neighborhood. As the main outcome of the technological part of the project the authors detail the TRYBe App, i.e. a digital facilitator for the Centocelle district.

Keywords;

Energy transition;
Active citizenship;
Socio-environmental-energy nexus;
Co-design;
Sustainable behaviours;

URL: <http://doi.org/10.5278/ijsepm.3339>

1. Introduction

This article is situated within the context of a research into sustainable models of smart cities and smart communities. The focus of the article is on the central role of citizens as actors of sustainable growth processes and urban regeneration in a smart sense through the use of governance technologies.

According to Demitri [2], a smart city is a set of urban planning strategies aimed at optimizing and innovating public services. This model of a smart city is able to relate the city's physical infrastructure to the human capital, intellectual and social life thanks to the widespread use of new communication technologies,

mobility, environment and energy efficiency, in order to improve the quality of life and meet the needs of citizens, companies and institutions.

Article 20 of 221/2012 Act (Italian Digital Agenda) [3], defines a smart community as a community built to form a connective structure (open, aware and focused) and, at the same time, an adaptive structure, capable of generating data and knowledge and making one's behavior evolve. Therefore, a city is smart when its inhabitants are smart in terms of skills, relational capacity of inclusion and tolerance and when governance models are aimed at giving centrality to relational goods and attention to common goods. Moreover, a smart city creates

*Corresponding author - e-mail: claudia.meloni@enea.it

Acknowledgement of value

The added value of the research named “A Smart Community in Centocelle District” is the setting up of an innovative methodology for the development of a local *smart community*, the promotion of co-governance, the participation in community life and the improvement of sustainable behavior, achieved through training and organizational processes, living labs and ICT technologies, tested in the Centocelle neighborhood in Rome.

This methodology is significant for the Centocelle district as it integrates technological and social aspects; furthermore, it facilitates processes to support transition towards urban sustainability, integrating sustainability meanings in environmental, energy and social resolutions.

The main output and results of this research offers to the district council a better facility support in the comprehension and outlining of strategies that strengthen urban and social regeneration and give, as feedback, the value of an informal path of collaboration between community and government.

Dario Pulcini, Councilor for Environmental Policies, Municipality V – Roma Capitale

opportunities to foster civic participation and builds public value.

As a consequence, a smart city is strictly connected to the creation of a smart community. As Meloni [4] affirms “training in social competences, structure of communities, active participation and spreading of cultural processes are initiatives that can activate sustainable behaviors in the citizens because profoundly anchored to tangible needs (mobility, economy, security, health, ageing...)”. Therefore, in a smart community, citizens are able to participate in decisions, to co-design sustainable initiatives and to promote conscious behaviours concerning energy and sustainability issues.

Starting from a structural and functional socio-energy, homology and nexus [5,6], the approach of this study is based on mutuality and reciprocity aspects that could depend on a new structured system for the alliance between society and a policy of sustainable energy.

This delicate promotion of the socio-environmental-energy nexus, comes from intensified studies on: a) secondary institutions and projection strategies [7], b) pre-cultural dynamics, c) ontologies of social-technical transitions and the multilevel perspective [7].

Studies on new social organizations that influence energy technologies adoptions [8] are the basis for this nexus.

In addition, it usefully takes in account how socio-economic aspects and technology are in reciprocity to influence each other in a projection strategy and in a democratic mutuality [9]. For this mutuality and democracy of relationship they have to share same

organizational principles and forms of expression that gather social and energy behavior in a common perception [10].

2. Methodology

This research consists in the development of a methodology for the co-creation of a smart neighborhood community capable of actively participating in decisions, activating informed behavior among citizens through actions of best practices concerning energy and sustainability issues. The activity has been conducted within the project known as “Development of an integrated model of a smart urban district” funded by the Italian Ministry for the Economic Development through the “Electric System Research” Program Agreements. It lasted 39 months from 1st October 2015 until 31st December 2018; significant partners have participated in the project, such as research agencies, national universities, private companies, the Centocelle council, various associations and the general public.

The project focuses on a systemic approach in which smart technologies are integrated to offer efficient and sustainable urban services to meet citizens’ needs.

To achieve that, a relevant cultural and relational network has been deemed necessary to create new conditions in order to grow and reorganize the social capital of a community that represents a crucial resource in terms of quality of life and welfare.

In Centocelle (Rome) urban district, a demonstrator of smart community was created; this paper describes

some experimental activities carried out with the aim of implementing a local Smart Community according to a model designed by ENEA [11].

The idea behind the Social Urban Network is that, through training courses, individual attitudes, synergies of social groups and so-called “smart” enabling technologies, it is possible to bring out resources and potential that reside in the local “communities” contributing to improve people’s quality of life and the very direction of “urban and social regeneration”.

The activity involves the development of a methodology based on a technological infrastructure and on initiatives aimed at triggering and enabling a process of growth in the participation and social cohesion of a community for the creation of a smart community.

This method, called “Social Urban Network” (SUN), is based on a system for the interaction of citizens in the urban context through an urban interactive installation and an urban social network.

The architecture of the Social Urban Network is composed of three main parts that concern the virtual, physical and conceptual world of the community in order to well represent what is the context offered to the citizen today, that is, a hybrid between physical and virtual worlds.

The developed methodology, therefore, focuses on the sharing of initiatives related to energy and environmental awareness in the community, sustainability, social planning of individuals or groups of citizens in such a way that the urban and social regeneration process can come together in a shared collective synergy.

One of the pivotal roles for the developing of a significant internal self-organization is the role of the “facilitators”, i.e. citizens who, spontaneously or organised in non-profit associations or in professional contexts, are proposed to facilitate the specific topics.

In the Centocelle demonstrator, some groups of citizens have been engaged through participatory initiatives acting on several smart community dimensions, such as co-governance, circular economy, sharing knowledge and proactivity.

Citizens were involved in both the energy and social aspects at different levels; in fact, in a specific activity, named smart home, some citizens have been engaged to increase their own level of awareness within their home energy consumptions [12]. A platform [13] and an app were developed to support this achievement.

3. Smart technologies for sustainable behaviors

In this perspective, smart technologies are crucial for enabling sustainable behaviors related to energy and social aspects, and the introduction of these technologies is also crucial in other projects on the Italian territory [14].

In the Centocelle project, the projections and the convergences of new social organization and human-techno capacities have been empowered through the implementation of a coordinated set of activities that develops in the web (social networks, web portals) and on the social scene (interactive installations, local initiatives) as well as new technologies (for example smartphones App and digital rewards systems).

This infrastructure is named Social Urban Network (SUN) and it aims to stimulate the community to share information, to express their needs for the improvement of their quality of life and to give feedback on the effectiveness and efficiency of the provided urban services.

The Centocelle SUN, named “Centoc’è” is composed by a front-end and a back-end, both managed by the SUN Manager. The structure of the Centocelle SUN is illustrated in Figure 1. The front-end consists of a web page (www.centoc.it), a Facebook page, a Facebook open Group and a Twitter channel. News and events concerning the district, are usually published on the Facebook page that is linked to a social streaming sub-page of the web portal. The Facebook Group is instead more focused on arising problems and opportunities in the district, and in general, focused on more dialectical issues. If something is very significant, it can be discussed in the Group, it can be shared in the Page and thus, in the portal. So, this makes the webportal the core of the SUN front-end, where every significant issue is recollected.

On the other hand, the SUN back-end is mainly made of a customized web based Social Analyzer (NetNoc App), which can trace citizens’ sentiments and feedback from all the social networks and from the portal itself.

The NetNoc App records, for every post on the Centoc’è Facebook Page, the following items: time of publication, number of likes, reactions, comments, replies and shares. For every post the NetNoc App also computes three metrics: engagement, interactions and NetNoc score.

We have also installed, as part of the SUN, a Smart Node, which is a 45” non-touch screen where citizens

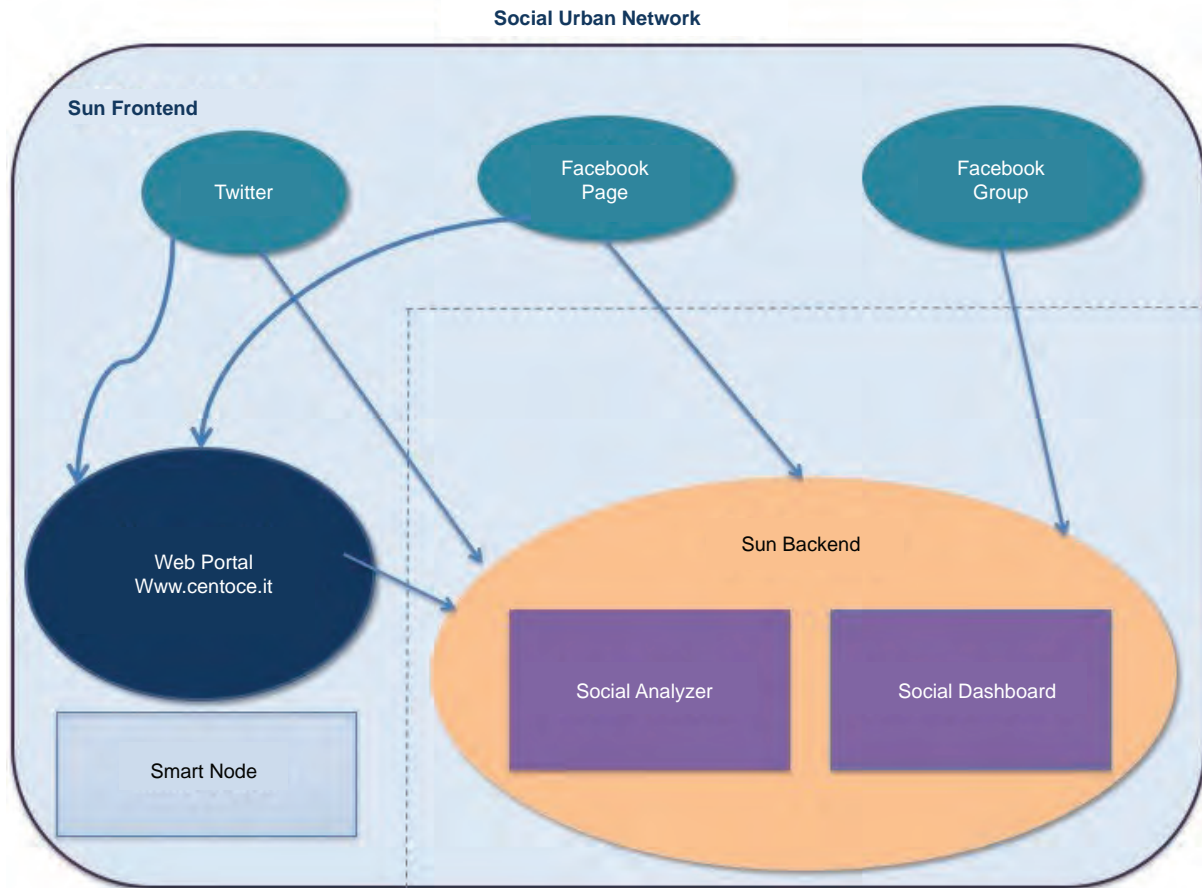

Figure 1: Centocelle SUN structure

can see the community streaming subpage of the Centoc'è webportal, advertisings of local initiatives and a short promo of the TRYBe App.

As part of our technological operations in the district, we decided to design and create the TRYBe App, a digital governance tool created to improve the model of the urban platform in the Centocelle neighborhood of Rome.

TRYBe App is made of the following elements:

- a Google Map based map where the projects are geo-located with pins,
- an asynchronous chat,
- a digital clipboard for notes,
- a progress bar,
- an helpdesk.

The map and two progress bars can be seen in the screenshot in Figure 2. After signing in to the App the user can add a new proposal choosing among four categories: Culture, Nature, Social and Green. Once the category has been chosen, users can fill in a form with

their proposal. When the submission is accepted users can add the key actions they intend to do to develop their proposal and they can get access to the resources that the district is offering to support their project. In order to reach the final stage of their proposals users must also interact with the helpdesk via an asynchronous chat.

In the App users can also access to their “medal collection”: here each user can see how many (if any) digital badges related to the TRYBe App they have earned. Digital Badges put learners in control of their credentials by enabling them to claim and display the badge on any platform. Digital Badges are portable rather than tied to one specific system (e.g., badging platform, learning management system, social media site) and they contain rich metadata that provide information about achievements such as who earned it, who issued it, the criteria required, and in many cases even the evidence and demonstrations of the relevant skills. Digital Badges are released by ENEA via the first Italian IMS Global certified platform, C-box (available at www.iqcheckbox.it).



Figure 2: Screenshots of the TRYBe App

Five kinds of Digital Badges are available in the C-Box Platform:

1. Open Badge which is a participation or check-in event badge;
2. Competence Badge which represents the ensemble of knowledges, competences and abilities acquired during the participation to an event or an experience;
3. Job Description Badge;
4. Recollection Badge;
5. Soft Skills Badge.

In the demo district of Centocelle, ENEA has designed and released only Open and Competence Badges: namely 1 Open Badge and 10 Competence Badges with the TRYBe App and 1 Open Badge and 4 Competence Badges for the college student smart lab.

Another activity developed in the framework of the Centocelle demonstrator is related to the integrated sustainability actions connecting environmental, energy and social issues. This was part of an engagement process aimed at involving citizens in the sustainable transformation of their district towards the creation of a smart community.

In particular, in Centocelle, an Urban Living-Lab (ULL) was created where urban innovation is conceived, designed, developed and evaluated as a result of a district stakeholders' active participation [15]. In fact, in order to help the promotion of healthier and more eco-sustainable life-styles, any innovation process should be open and its creative phases should be guided directly by the user. A collaborative approach based on a user-driven open innovation process is renown as Living-Lab, [16].

Actually, the Centocelle ULL puts high attention on experimentation and co-creation process, allowing the exchange of interdisciplinary knowledge among scientific communities, citizens, companies and local administration. One of the main issues discussed during the Centocelle ULL phases, was the promotion of a Circular Economy transition at urban level. According to EMF [17], Circular Economy (CE) is an emerging concept for a systemic shift from unsustainable linear models (based on take-make-dispose approach) towards circular models.

The application of CE at urban level aims to achieve the maximum value from the use of all resources, products and waste, fostering energy savings and impacts reduction [18].

As a result, implementing circular economy at urban level can enable gaining business and economic opportunities, also providing environmental and societal benefits. Therefore, a circular economy contributes to building long-term resilience and sustainability in urban area. Results of these practices have been analyzed in terms of potential energy-environmental advantages related to the adoption of circular economy approach at urban level. In particular, during the ULL phases different CE models were identified within Centocelle District, such as coworkings, community gardens, km0 practices, second-hand markets. These models are based on CE strategies, such as regeneration, sharing, optimization and closing-the-loop [17]. This research has investigated the benefits related to CE strategies adoption. As a result, several benefits have been highlighted in terms of energy saving, waste prevention and CO₂ emissions reduction.

Other relevant engagement processes have concerned the establishment of two smart educational laboratories: one for facilitators and one for college students. The laboratories act as creative spaces for the development of project and communication ideas, focused on the themes and objectives for integrated sustainability (economic, environmental and social).

Therefore, some of the facilitators' proposals focused on sharing economy, energy and environmental issues. In particular, "Recyclability" is the name of a proposal that entailed the creation of an 'urban factory of the reuse and recycle' through demo services; "Culturhub" is another proposal that focuses on a centre that can offer a range of sociocultural services through educational and formation programmes; finally "Real ideas Co-lab", aims to create an incubator of ideas for sustainable projects about district services designed by the citizens.

The accompanying activity of the facilitators also led to another important result: the creation of a neighborhood Community Cooperative, called CooperACTiva, the first community cooperative in a complex urban area. Specifically, the Cooperative is a multiplier of its experience and a new adapter of needs being defined. This new economic operator, governed by the district facilitators, aims to contribute to the struggle that public and social operators daily lead against the digital, social, economic and infrastructural divide that characterizes the suburbs of the big cities. It will do so through a social business plan that will create work for the inhabitants of the neighborhood with activities connected to sustainable integrated tourism, energy issues, culture and creativity, circular economy, collaborative digital and neighborhood services.

CooperACTiva has achieved the aim of making some citizens entrepreneurs and investors not only managers of common assets. In particular, social workers protected by Italian Law 142/2001, have shown that they are taking the path towards the social economy where shortly, energy community could be triggered.

The phase of adjustment and evolution of the governance and the routes of hybridization with the local government is still underway, demonstrating a certain management capacity. Further possibilities to widen the fields in which the Cooperative can operate are those of:

- assisting the accompaniment of other local and non-local cooperative forms;
- strengthening the relationship with the 5th Municipality of Rome
- training service for future social workers
- sponsorship research and self-financing management
- public and private mix services
- energy transition integration.

Finally, CooperACTiva will reinvest all its profits in projects and activities for the benefit of the neighborhoods concerned. It is the first time that this particular form of business, which offers citizens the opportunity to be active protagonists in the management of common goods to respond to their needs, is experimented in a complex urban reality like that of the outskirts of the capital. It is a collective institution and / or community enterprise for urban / local co-governance through the co-management of urban common goods and / or the provision of collaborative social-digital district services in a logic of sustainable local development.

The whole task on Centocelle community has been realized by ENEA research team on smart cities and communities; Municipality V – Roma Capitale; LUISS University - LabGov (Laboratory for the Governance of Commons) that has developed and tried out a co-city methodological protocol for the local co-governance; Transition Italia, that had lead an urban facilitation laboratory for the circular economy; Fusolab Association for the content management of the Social Urban Network centoc'è; Periaogò Association for the definition of a training methodology for a school smart lab; Art Attack srl that has developed the ICT architecture of the Social Urban Networks; Pomiager srl for the development of TryBe app.

4. Conclusions

The Centocelle project has validated the model that will allow Centocelle neighborhood to become not only a smart community but also a self-governed community.

The success of the model discussed in this article is strictly related to a deep community engagement. However, such an engagement can only be obtained for matters that are already emerging within a community, i.e. a community cannot be motivated to feel engaged in a theme which is not coming from the community itself.

Another central point of the model is that, in order to succeed at a community level, the community itself has to accept and actively promote a self-sustainable economic policy, that can be harnessed through constant participation of local associations, crowdfunding projects and other initiatives aimed at enhancing the human capital.

Finally, the model demonstrates that, when dealing with social dynamics, outcomes are often related to unpredictable factors related to human behaviors of individual citizens within the society.

A task of the project has focused its attention on developing a group of district facilitators able to promote initiatives for urban and social regeneration of the neighborhood, based on circular economy principles.

To achieve that a Living-Lab was created, an open innovation environment where transformative and regeneration processes are guided directly by users; in this way the facilitators could be directly involved reducing the distance between different roles and capacities.

Inspired by the principles of centric and polycentric community, such as the American models of “Smallest Unit neighborhood”, Centocelle has developed many

organizational centers that reproduce common principles promoted by a new and innovative organization of governance as the center of interpretation of the priority needs for the community itself: the Cooperative of Community CooperACTiva that is continuously evolving.

The process carried out in the Centocelle district, has investigated the level of acceptance of an innovative technology through some surveys on families involved in its testing, highlighting:

- the desire to redesign the technology itself on the basis of knowledge of involved subjects.
- the need for energy efficiency has come second ahead of structuring a technology of integrated services.

In addition, the SUN model has received additional enhancements inputs as well as the TRYBe App. The experiment in Centocelle has highlighted that the citizens take into great consideration integrated sustainability and, in particular, energy transition, referring to the cultural conditions and adaptation in which they want to renew themselves, fixing the limits of adaptation through the lens of new social structures and in relationship of energy technology offer.

Consequently, the Centocelle project delivers an exhaustive contribution to theories and studies on governance and on energy communities focusing on:

- the importance of organizational governance considered as the space that facilitates the emersion of new sustainable projects.
- the importance of developing energy communities within an expanded framework of social capacities that are linked to other issues (not only the energy one).
- The importance of making internal and external roles, capacities, spaces converge in order to build a new knowledge process.

The gap that this study highlights is that energy transition cannot be treated as an a-priori task, but an aspect of the community that transpires after an experience of convergence between socio-technical performance and behavior.

The energy-society combination will be achieved through the perspective of energy communities, in which groups of citizens will be able to gain environmental, economic and social benefits by sharing the production and consumption of energy (prosumers) from renewable sources.

Acknowledgements

This article was invited and accepted for publication in the EERA Joint Programme on Smart Cities' Special issue on *Tools, technologies and systems integration for the Smart and Sustainable Cities to come* [1]

References

- [1] Østergaard PA, Maestoso PC. Tools, technologies and systems integration for the Smart and Sustainable Cities to come. *Int J Sustain Energy Plan Manag* 2019;24. <http://doi.org/10.5278/ijsepm.3450>
- [2] Demitri, M. (2016). Le Smart City: città intelligenti, digitali ed inclusive. www.marcodemitri.it.
- [3] https://www.agid.gov.it/sites/default/files/repository_files/leggi_decreti_direttive/dl-18-ottobre-2012-n.179_0.pdf
- [4] Meloni, C., Tundo, A., Paoloni, G., Orsucci, F., Cervini, F. (2017). Dalla smart city alla smart community, in *EAI 1/2017* pp.40-45. <http://eai.enea.it/la-rivista/anno-2017>
- [5] M. Covarrubias, G. Spaargaren, I. Boas, Network governance and the Urban Nexus of water, energy, and food: lessons from Amsterdam in *Energy, Sustainability and Society*, 05/2019.
- [6] G. Fuchs, From the economist's point of view - a review of the "The German energy transition: Design, implementation, cost and lessons in *Energy, Sustainability and Society* 05/2019
- [7] Kardiner in D. Cohen, S. Kitayam *Handbook of cultural psychology* Second edition. The Guilford press 2019.
- [8] F.W. Geels, *Ontologies, socio-technical transitions (to sustainability), and the multi-level perspective*, Elsevier, 2010.
- [9] Mori, P., A., 2014, "Le ragioni economiche della cooperazione di utenza nella gestione dei servizi pubblici", in L. Sacconi (a cura di), *Beni comuni e cooperazione: una prospettiva etica, economica e giuridica*, Bologna, Il Mulino, 187–206.
- [10] Community Catalysts (2014). *Microenterprise*. Disponibile al sito: <http://www.communitycatalysts.co.uk/products/micro-enterprise/> (Ultimo accesso 10/10/14 Dickinson H., Glasby J. (2010).
- [11] Annunziato, M., Chiarini R., Mariano A., Mastrolitti, Meloni, C., Chiarini, R., Novelli C., Pistochini P., Tundo, A., Zini P. (2016). "La metodologia per la smart community e la co-governance del distretto". Report RdS/PAR2015/017. http://www.enea.it/it/Ricerca_sviluppo/energia/ricerca-di-sistema-elettrico/accordo-di-programma-MiSE-ENEA-2015-2017/efficienza-energetica-negli-usi-finali/smart-city-smart-community/report.
- [12] Romano S. Experimental demonstration of a smart homes network in Rome. *Int J Sustain Energy Plan Manag* 2019;24. <http://doi.org/10.5278/ijsepm.3335>
- [13] <https://www.smarthome.enea.it>
- [14] Cassinadri E, Gambarini E, Nocerino R, Scopelliti L. Sharing Cities: from vision to reality. A people, place and platform approach to implement Milan's Smart City strategy. *Int J Sustain Energy Plan Manag* 2019;24. <http://doi.org/10.5278/ijsepm.3336>
- [15] Cappellaro, F., Cutaia, L., Innella, C., Meloni, C., Pentassuglia, R., Porretto, V., Co-design of a circular economy through Urban Living labs: transformative practices in Rome (Italy). *Urban Transformation*, 1, in press.
- [16] Bergvall-Kåreborn, B. & Ståhlbröst, A. (2009). Living Lab: An Open and Citizen-Centric Approach for Innovation. *International Journal of Innovation and Regional Development*. 1. 356-370. <http://doi.org/10.1504/IJIRD.2009.022727>
- [17] Ellen MacArthur Foundation, (2015), *Growth Within: a Circular Economy Vision for a Competitive Europe*, SUN, McKinsey Center for Business and Environment. https://www.ellenmacarthurfoundation.org/assets/downloads/publications/ElleMacArthurFoundation_Growth-Within_July15.pdf
- [18] EMF, Ellen MacArthur Foundation, (2017). *Cities in the circular economy: an initial exploration*. https://www.ellenmacarthurfoundation.org/assets/downloads/publications/Cities-in-the-CE_An-Initial-Exploration.pdf

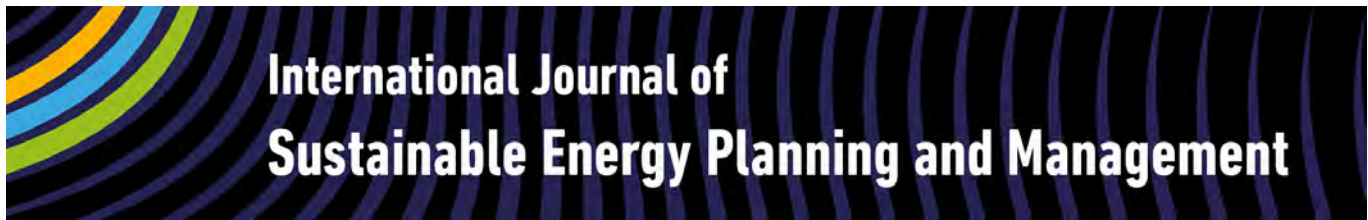

Virtual round table on innovation for smart and sustainable cities

Paola Clerici Maestosi*, Peter Berkowitz, Han Brezet, Jonas Bylund and Giovanni Vetrutto

URL: <http://doi.org/10.5278/ijsepm.3502>

INTRODUCTION: *Why a Virtual Round Table on Innovation for Smart and Sustainable Cities?*

by Paola Clerici Maestosi

Innovation is, according to the definition given in *Innovation in Firms: A Microeconomic Perspective*, OECD, 2009, the “*implementation of a new significantly improved product, good, service, or process, a new marketing method, or a new organizational method in business practices, workplace organization or external relations*”.

We know that innovation can be incremental – in terms of optimization of existing products, services or systems - or radical such as innovations which dramatically change social and business practices, and create new markets.

Concerning the urban dimension, specifically sustainable urban development, it appears clear that incremental improvement, whilst potentially important, could not be sufficient to bring the required structural change.

Cities are indeed the best place to experiment innovation as its societal dimension is characterized by a combination of technology, infrastructure, production systems, policy, legislation, user practices and cultural meaning.

Moreover cities are interconnected social, technical and ecological systems made by people, infrastructures, buildings, flows, functions and services.

Cities are the principle engines of innovation and economic growth.

However, urban activities consume a significant amount of resources, generate waste and pollution, and cause structural depreciation.

Due to our increasingly globalised production and consumption systems, negative environmental impacts are felt locally and globally.

To achieve sustainable urban development, targeted growth in key technology sectors, is required to provide the infrastructure and solutions that support operations and behaviours which reduce the negative environmental impact caused by urban life and urban development.

It is a shared opinion that sustainability challenges cities are facing cannot be approached and supported by traditional disciplinary modes of research, innovation and funding as the limitation due to working with the silos approach is misleading.

This does not mean that there is only one pathway to support the transition to sustainable urban development.

This Virtual Round Table on innovation for Smart and Sustainable Cities compares pathways experimented in three different country in Europe: Netherlands thanks to the point of view of Han Brezet, Sweden thanks to Jonas Bylund, and las but not least Italy thanks to the contribution of Giovanni Vetrutto.

Added value is the foreword provided by Peter Berkowitz Head of Unit - Smart and Sustainable Growth, Directorate General for Regional and Urban Policy, European Commission.

I would like to thank all of them and express my sincere appreciation for their contribution.

*Corresponding author - e-mail: paola.clerici@enea.it

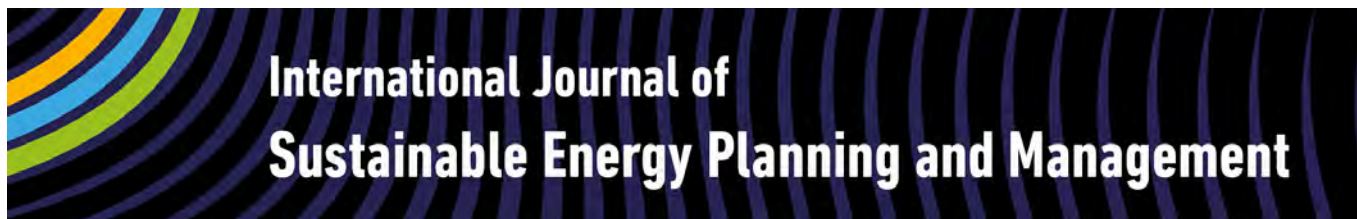

International Journal of Sustainable Energy Planning and Management

DIALOGUE

FOREWORD

by *Peter Berkowitz*

Head of Unit - Smart and Sustainable Growth
Directorate General for Regional and Urban Policy
European Commission

The European Union needs to reach net-zero greenhouse gas emissions by 2050 if it is to contribute to stabilising the climate this century, as reflected in recent IPCC reports. A communication from the European Commission last November (European Commission 2018) showed that this is challenging but feasible from a technological, economic, environmental and social perspective. As such, the UN Sustainable Development Goals (SDGs) provide a guiding framework to address both the environmental and social dimension of moving to net zero-carbon societies.

However, there are many uncertainties regarding potential pathways towards the achievement of deep societal and economic transformations necessary to achieve this shift. Indeed, given the diverse starting points and the magnitude of the changes for our economies and societies, this will affect unevenly citizens, regions and sectors across Europe.

For instance, many parts of Europe need to diversify their economies as they move out of carbon-intensive or coal activities. Fast growing regions face different types of challenges, such as increasing congestion, growing energy demand and population pressures. With increasing urbanisation, cities and urban areas will even play an increased role in this transition. At the same time, the involvement of rural areas will be essential, notably as regards the sustainable production of food and renewable energy sources.

Public, private and civil society actors at local level will deliver these changes on the ground. The European Union will play an important role in supporting them to deliver a just and inclusive transition. This means a process of transition that is good for people, manageable at local level, benefits our businesses whilst at the same

time leads to the necessary greenhouse gas emissions reductions and less pressure on the environment.

Deep transition requires new solutions

In order to facilitate a process of deep transition, Europe needs new policy approaches to promote emerging industries and new value chains, based on breakthrough technologies. Businesses need access to technical knowledge and the expertise of other actors to develop innovative solutions and participate in new value-chains. Further action is therefore needed to facilitate deeper strategic inter-regional collaboration along industrial value chains. By building on investment in areas identified as part of smart specialisation strategies, participants in the quadruple helix can identify new areas of potential collaboration.

Smart specialisation strategies within the EU's Cohesion Policy ensures that industry, researchers, public sector and civil society work together to identify business needs and local opportunities for investment in innovation. These strategies are a pre-condition for Cohesion policy support – €41 billion for the 2014–2020 period – to areas of innovation-led growth potential. Energy has been one of the most common areas chosen in these national and regional smart specialisation strategies. This means that significant funding in the area will also be available and more importantly opportunities for cooperation. To support the cooperation and have real projects across the energy innovation chain, the Commission is promoting the creation of partnerships between the interested regions. These partnerships aim at connecting regions with similar smart specialisation priorities and helping them realise innovative projects across the value chain. So far, five partnerships have launched in the area of energy – on marine renewable energy, on bioenergy, on sustainable construction, on smart grids, and on solar energy.

In order to test new approaches to developing innovative solutions to transition, the Commission has launched two pilots (European Union 2018). One of the pilots is



International Journal of Sustainable Energy Planning and Management

DIALOGUE

aimed to help interregional innovation projects across value chains, including on energy (for sustainable construction and for marine renewable energy). The other pilot supports the industrial transition of regions that are experiencing specific structural challenges linked to technological change and the transition to a low-carbon economy. The results of these pilots will feed into the development of smart specialisation strategies post-2020.

The role of cities needs to be further strengthened in managing the low carbon transition

Engaging stakeholders in regional and city planning and economic development processes increases the ownership and better embeds action in the local setting. Many cities have organised public consultations and citizen involvement in projects with EU funds and the partnership principle is, for example, a cohesion policy requirement. However, more can be done to increase the role of cities and to engage citizens across Europe.

An example of such engagement is the Urban Agenda for the EU, which aims to strengthen the urban dimension in EU policies and to improve the involvement of urban authorities in their design and implementation. The agenda represents a new multi-level working method promoting cooperation between Member States, cities, the European Commission and other stakeholders through thematic partnerships. Work on the fourteen partnerships is currently ongoing covering key urban and related low-carbon transition themes¹. It shows that collaboration between different levels and broad engagement of stakeholders can give a multitude of solutions to concrete problems cities face that are tailored to the needs of these cities.

EU funds to support deployment of new solutions

The EU funds – although small compared to the investment needs – play an important role in stimulating the

change on the ground. In particular, EU cohesion policy has a long experience in supporting industrial and environmental transition of Europe's regions. It provides financial support for investments in a wide range of areas that contribute to smart, sustainable and inclusive growth and jobs. More importantly, Cohesion policy also represents a policy framework for integrated territorial development and is particularly well suited to address issues related to structural change, working in partnership with actors on the ground in a place-based and holistic approach.

For example, in the current 2014–2020 funding period, EU cohesion policy provides substantial support for the realisation the Energy Union on the ground. This includes significant funding of EUR 69 billion – or around EUR 92 billion with national public and private co-financing – for investments in a variety of projects across the five Energy Union dimensions. Implementation is progressing well, with 71% of the total funding allocated to projects by end 2018. Importantly, this support goes beyond funding and cohesion policy provides Member States, regions and cities with administrative capacity building and technical assistance and cross-border cooperation possibilities, so that investments actually contribute to a real and lasting transition.

For the 2021–2027 period, Cohesion policy will continue to put a strong emphasis on supporting a clean and fair energy transition, by supporting innovation and the deployment of new solutions. It will do so by supporting Europe's cities and regions to anticipate and manage the energy transition in a targeted and tailored manner. The regulatory proposals offer a shorter, modern menu of priorities to build smart, green, low-carbon and more social Europe. Urban and territorial aspects are given more prominence with a separate priority objective. Finally, the Commission has proposed a dedicated instrument to support the development of interregional value chains as well as reinforcing the commitment to the Urban Agenda with the European Urban Initiative.

¹ e.g. energy transition, climate adaptation, jobs and skills in the local economy, mobility, urban poverty, housing, air quality. For more info: (European Commission 2019), (European Commission n.d. A)

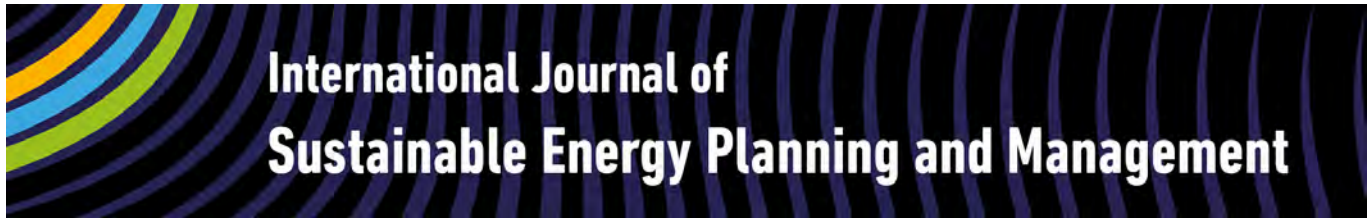

Concluding remarks

Europe must accelerate its transition towards a carbon-neutral economy. This can only be achieved by the full engagement of regions and cities in a process of deep transition. Through Cohesion policy, the European Union will strengthen its support to this process, notably through support to smart specialisation,

deployment of new solutions and development of value chains. However, success will depend on engaging all relevant actors at all levels. This will require new ways of working, the development of new models of public sector management and a deeper understanding of the policies that can facilitate system change at subnational level.

International Journal of Sustainable Energy Planning and Management

DIALOGUE

POINTS OF VIEW

A dialogue between Paola Clerici Maestosi, Han Brezet (NL), Jonas Bylund (SE) and Giovanni Vetrutto (IT)

Paola Clerici Maestosi: *The shift from New Public Management to Multilevel Public Governance lies on promoting innovation in public administration. Has this process taken place in your country?*

Han Brezet: The developments of the last ca. 50 years in The Netherlands cannot be well understood without the history model of Braudel, distinguishing between three type of waves in societal development: the longer term, conjuncture waves and events (Smith, 1992). In our case, without the “House of Europe”, and its institutionalization including innovation aimed policies and instruments such as the different innovation related directorates and R&D programs, which could be seen as part of the longer-term wave, developments in the national innovation ecosystem cannot be well explained. However, *ceteris paribus*, here we will focus mainly on the conjunctural waves, with events mostly as their illustrations. We argue that in The Netherlands within the conjuncture a ‘polder (wetland) paradox’ exists in which at the same time NPM models survive and new forms of MPG pop up, living in co-existence (Celik, 2018)

In The Netherlands this goes back to the creation of large parts of the country -the long-term wave- of land reclamation, dike building and water works engineering and management. From its’ origin, this required on the one hand village level initiative, entrepreneurship, skills and local co-design and cooperation but on the other hand governance within the region and country, leading to the establishment of regional Water Board bodies, as multi-stakeholder entities, including representatives from the higher national levels. (Mostert, 2017) This historically grown governance model -partly due to its geographical position below the sea-level and

experienced flooding danger from both rivers and the sea- is still at the core of today’s approach of innovation in the country: while the Water Boards can be regarded as examples of semi-self-steering NPM agencies, using a decentralized service delivery model, at the same time their daily program consists of co-developing and co-managing their waterworks related activities with a variety of actors, using a MPG-like multi-stakeholder approach: the Dutch innovation governance paradox.

Therefore, both developments can be observed during the last decades. In areas such as health care, social care (elderly, youth), social building sector, energy sector and education definitely the private-style corporate governance model has been dominant. However, this has lead in various cases to lower quality of public goods’ services and personnel dissatisfaction in many ways and areas, due to too intensive competition on common good markets, where instead cooperation and joint planning would make sense, like in the care for the elderly.

A NPM-adapting movement can now be observed in The Netherlands, building theoretically strongly on the model of Mazzucato (Mazzucato, 2018), which acknowledges a crucial guiding and facilitating role for governments in societal relevant innovation in stead of leaving this to business and privatized government agencies. Such an approach has to bring back responsibilities close to governments or avoid market competition in common good areas.

A less shock wise and more insidious, though very significant MPG-related trend in the Netherlands’ innovation ecosystem stems from the design disciplines. Starting 50 years ago at the Delft University of Technology as the new discipline ‘industrial form giving’, today design thinking and industrial design disciplines have reached all capillaries of society, not only in higher

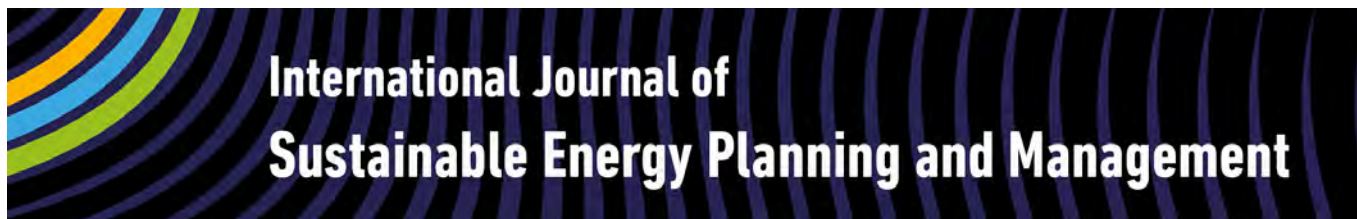

education institutes, industries, but also in governments at all levels, within consultancies and other members of the quadruple helix. By joining forces with the art disciplines, a new and powerful business sector has emerged, the ‘Creative Industry’, which is now cooperating intensively with the more traditional R&D and technology oriented industry and innovation sectors. Nearly all higher education institutes in the country have a department for design, or have design thinking in their missions and programs, leading to a significant change in innovation paradigm, where user involvement, multi-stakeholder engagement, out-of-the-box solutions, creativity tools and methods, and common good -United Nations (UN, 2017)- goals orientation are becoming standard. Top-down, government is stimulating this with both institutionalization and Creative Industry aimed programs. Furthermore, this trend is supported by the philosophy of Richard Florida on the creative class (Florida, 2012) and by Dutch -mostly sustainability driven- innovation thinkers’ theories, conceptualized as Transitions Theory or Sociotechnical Transitions Theory (Geels, Elzen & Green, 2004. Sovacool, 2017. Ceschin & Gaziulusoy, 2019). This philosophy, which is quite influential in the country, suggests that -radical- societal transitions can occur via interactions among three levels: the niche, the regime and the landscape.

Here, the Dutch Paradox is expressed quite clearly: a hybrid governance model, top-down oriented at creating new rules and entities at a distance -regimes- for -sustainable- innovation, with their semi-private mission and tasks, while at the same time design thinking=joint product- and service development and management notions and practices infiltrate all levels of society, starting bottom-up in niches.

Jonas Bylund: Yes and no. There is an increasing awareness not just in planning and organisational studies but also in public sector and administration development circuits that the New Public Management (NPM)

approach perhaps did not lead to the anticipated – or promised – effects.

The point of departure for NPM in Sweden was tied up in a push for devolution and increased local democracy in local democratic settings, i.e. municipalities. The effects were rather ‘headless chicken’ (Barrett 2004) and that more and more issues and challenges in the everyday work of local urban governance falls between chairs. The need stems from a sense that current issues and concerns, particularly challenges around the UN Agenda 2030 and the Sustainable Development Goals, escape the current sectoral and silo organisation of most public administrations. In a way, it is a kind of emergent public, although with a focus on public administrative persons and capacities rather than the typical civil society and other in the neo-pragmatic resurgence over the last decades (cf. Marres 2010).

Hence, after a couple decades with NPM reforms: ‘What we can see, then, is that an administration that was initially relatively independent has become even more “bottom heavy” since the 1980s...’ (Hall 2013: 409); since

‘Public-sector management in Sweden used to be characterised by its relatively detailed, hands-on nature, while at the same time allowing a certain latitude: within their budgetary frameworks and outside areas that were regulated in detail, public authorities could, in principle, do what they liked...’ (Hall 2013: 408) Of course, Swedish municipalities still retains their ‘planning monopoly’ on land-use (except areas of national interest in terms of e.g. military or biotope importance). This means that there is less to vertically integrate from a municipal local governance point of view. (On the Swedish territorial administrative set up, see e.g Bäck 2003).

By NPM and its role in European planning and policy, I rely mainly on the understanding conveyed by Barrett’s (2004, pp. 257) more than a decade old synthesis on the field of policy implementation. Here, the sense of NPM is the transfer (and not really translation) of business and industry management principles and practices onto



International Journal of Sustainable Energy Planning and Management

DIALOGUE

public administrations, with accompanying new or re-mixes of centralisation/decentralisation balances as well as a discursive change around policy implementation and meaningfulness.

In Sweden, then, the sense at the moment is not that multi-level public governance simply succeeds NPM. Firstly, since NPM is also an effect of the rise of governance (as a political science concept) in contrast to mid-20th Century understandings of government in the West.

Secondly, because multi-level public governance as a counter-movement to NPM (if it can be characterised as such given the general governance characteristics just mentioned) is probably better understood in Sweden as New Public Governance (NPG). Although NPG is not strictly a counter-movement, there seems to be a non-linear move from the one to the other, and in parallel by a rather more focus on what we might call New Public Services (NPS) to stem and rectify the effects of NPM – and which has been around simultaneously as NPM proper. A contrast between NPG and NPS might be seen in the former's focus on organisational capacity whereas the latter is more focused on the product and delivering the service, so to speak. The former, in terms of promoting innovation, works more in terms of Public Innovation Governance, whereas the latter is more about Public Service Innovation.

However, it's never that easy. The shift is not a clear-cut one and it seems, when talking to colleagues out in 'the system' that all three occur at the same time and are currently active ways of structuring everyday urban planning and management, in different degrees in various municipalities.

There is, of course, a distinction to be made on innovating public services, on the one side, and innovation governance, on the other. The former has more to do with the products and services the Swedish public sector is to provide in some or the other way and where e.g. schools, primary education, transport and mobility, public utilities and housing was privatised in different

and varied degrees during NPM reforms. The latter, public innovation governance, has more to do with the capacity to enable, support, and innovate in complex governance situations. (cf. OECD 2011; EC 2011)

However, the multilevel governance aspects may be more appropriate to understand as NPG?

Giovanni Vetrutto: The sunset of NPM comes from a functional and theory point and not from a technological point; nevertheless, ICT gave the main instruments to overcome its impasse world (Osborne & Gaebler, 1992; OECD, 2005).

The prevalent address of NPM from the late 1980s to the early 1990s (Pollitt & Bouckaert, 2004), led lately to a general disaffection with that approach, especially in the countries that experimented it in a deeper and pervasive way (like New Zealand and Great Britain); then the new paradigm of MPG rose on totally different socio-economic and organizational principles (Vetrutto, 2010).

In the context of a strong revival of the free market neoclassical approach, NPM inspired reforms that were reduced to the logic of microeconomic efficiency. The only admitted public value to be produced was the sum of separate single microeconomic efficient services. As a consequence, a number of quasi-markets for single administrative services or products were enabled.

As a matter of fact, NPM was not the adoption of managerial technicalities in the skills matrix of public managers; it was a comprehensive organizational and institutional rebuilding that gave start to the so-called process of agencification (Christensen & Laegreid, 2006; Verhoest, 2017): the outsourcing of public single-product bodies with business goals and models.

The most ambitious reform in this sense was realized in New Zealand during the '90s, and since the early years of the new century saw dissatisfaction and changes of address, because, on the one hand, the fixing of medium and long term microeconomic performance goals in separate agencies precluded wider, integrated



International Journal of Sustainable Energy Planning and Management

DIALOGUE

and horizontal policies with more ambitious goals; on the other hand, the “business oriented” approach came to predominate in the electoral circuit (citizens – parliaments – governs) in the pursuit of more complex goals, other than the saving of resources, for example in the changing of socioeconomic conditions considered unequal or in any sense not approved by the majority of the electoral body (Rennie, 2005).

The most important criticism to the NPM model, anyway, moved on a different level: it implied the inadequacy of the “quasi-market” logic on a conceptual and cognitive basis.

NPM was based on the wrong assumption of considering means and goals of the administrative (and political) action as known. That was barely possible in the small number of years that saw the prevalence of the neoclassic revenge, of the minimal State and of the self-regulation of rationale social actors disputed. Until then the simple contractual or quasi-contractual logic was considered sufficient to solve the main collective problems and challenges.

When this prevalence started to unravel, long before the major crisis of 2008, preferences and orientations of the majority of citizens started moving to the request of more demanding and integrated policies, which the contractual and business-oriented model couldn't afford to give (Guy Peters & Pierre, 1998).

For a number of years, the world blindly believed only in the return to the logic of the invisible hand and of the pull of efficiency. The technological revolution that started at the end of the last century gave to the economic actors more and more room for efficiency gains and organizational rationalizations, leading to the overcoming of Fordism. In more recent years, the same technologies have given the economic actors a new awareness about the chance to reconsider transactional, organizational and operational choices using the network model, the “coopetition” dynamics, and more interconnected relations between private and public sector: the referring is to the concept of milieu innovateur theorized in the nineties by Manuel Castells (2010). On a territorial

level, there has been a rediscovery (Hidalgo, Klinger, Barabási & Hausmann, 2007) of the Hirschmanian economic theory of agglomerations (Hirschman, 1958, 1963, 1967), highlighting the basic value of social capital and distributed knowledge (Dahrendorf, 1959, 2003).

The revenge of the market versus the State left progressively room to a new awareness about the inextricable connection of the public and private sectors, especially by means of the new “connective” and “cooperative” ICT technologies. What once, in the words of the most important Italian political scientist of the last century, was the “great dichotomy” between “public” and “private” became a syncretism of both (Bobbio, 1974).

A number of cultural developments stemmed from this change of attitude in policy making: from the new success of the theory of capitalism of Karl Polanyi (2013), to the Nobel prize of a thinker like Elinor Ostrom (2007), who dedicated her entire research life tearing down the enemy's myths of the Leviathan State and of the self-regulating invisible hand market. Ten years ago important scholars already declared the NPM overcome (Dunleavy, Margetts, Bastow & Tinkler, 2006); the reason for that is the more useful and elastic methodology offered by the MPG in shaping and conducting public policies in the era of new digital means; an era characterized exactly by being digital.

Paola Clerici Maestosi: *Which are the most innovative instruments and fields/domain of application?*

Han Brezet: The shift from an at first instance institutional and NPM-oriented innovation policy is now more and more enriched with and based upon MPG-elements.

Good illustrations of modern MPG approaches can be for instance found in the higher education and sustainable innovation area.

The Dutch science agenda is now aligned with general public participation on urgent societal issues: via an intensive consultation of the general public's opinion by means of questionnaires, interviews and group

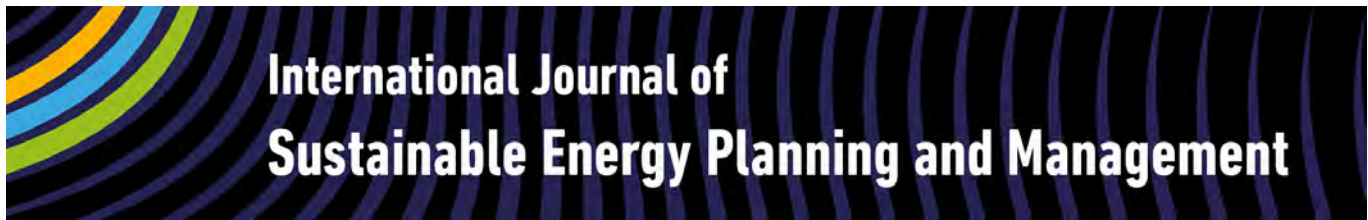

meetings as well as modern digital media, during the period 2015–2018, 11.700 research questions have been gathered from the Dutch population as relevant inputs for the national science agenda. Via a joint design process of scientists, policy makers and government departments, knowledge users, industry sectors and civil society, these issues have been translated into 140 clustered problem areas and 25 ‘grand challenges’ knowledge routes, including structural funding of more than €130 million per year. This national science agenda is shared with regional science programs from one or more provinces and with innovation strategy agenda’s of cities. (Ministerie OCW, 2018.)

In line with this development, new programs with enlarged bottom-up project options have been designed for polytechnics and SMEs as well as local Innovation Labs, Design Factories and incubators intensively promoted and facilitated. But a major role also can be distinguished here for the universities and other higher education institutes, who during the last decades very successfully, bottom up, are stimulating innovation via spin offs and new ventures at their campuses, both with a low- and high-tech character.

From these and other examples, various lessons also can be learned with respect to orchestration and governance in digital platform ecosystems (Mukhopadhyay & Bouwman, 2019).

Jonas Bylund: The applications or, rather, exploratory settings to develop public administrative innovation in Sweden does not necessarily follow the multilevel public governance recipe, but rather starts to organise around innovation capacities and around ‘boundary spanners’ and supporting mechanisms such as the Project Studio in Borås² or issue-oriented approaches like trust based governance by task-forces in Ängelholm.³ These counter measures are seen as a capacity building to regain and reinvent what has been lost during NPM – which is still operational – and to shape

organisations that are dynamically more robust in terms of organisational learning and tackling wicked issues in complex situations such as urban planning etc. This is in line with the ultimate objective to both increase skills and enable UN Agenda 2030 as well as safeguard basic public services provision. These boundary spanners are not sufficiently captured in any conventional vertical/horizontal axis understanding.

The shift or, rather, the approaches to tackle these issues in complex municipal development and systemic innovation has been flocking around (explicit, intentional) experimental approaches, many times by approaches similar to urban living labs. In this regard, particularly a growing interest in boundary spanners, congruent with the intermediaries seen as crucial for transformation capacity building (e.g. Wolfram 2018) has been noticeable lately.

Giovanni Vetrutto: The most relevant projects that led to MPG frameworks came not from a direct central intervention more from a pure local initiative.

In 2006 a complex center-periphery program, named ELISA, was launched and produced the best results using a simple but effective scheme: the center (a department of Prime Minister’s offices entitled about local government) addressed threats and goals, and a combination of regional and local authorities proposed the solutions, gaining the financial instruments to realize its plane, tool and platform (Conti, Vetrutto, 2018).

The ELISA funding program (Enti Locali – Innovazioni di Sistema, Local Authorities – System Innovation) was introduced in 2006 as an instrument to create a national fund for the investment and the innovation in the local authorities and in its decade of operation, it gave an important contribution to the organizational and technological modernization of the Local Authorities. This attempt can be considered as a precursor with respect to what would later be the prevailing attitude of those European policies which, in view of the challenges of the international economic crisis, responded favoring the local dimension of development. In practice, this has

² <https://www.innovationsplattformboras.se/projekt/projektstudio>

³ https://portal.research.lu.se/ws/files/48486503/SOU_2018_38_Final3.pdf



International Journal of Sustainable Energy Planning and Management

DIALOGUE

resulted in financing fewer but major projects, investing in innovation and Local Authorities, where technological innovation has fully shown it can be the lever for streamlining and enhancing public functions.

The three main fields that were innovated through this program were:

- **INFO-MOBILITY:** integrated management of logistics and info-mobility in local public transport in the urban and suburban public and private mobility. This means new systems for monitoring and managing fleets, for traffic control and regulation of traffic light cycles, for air pollution detection, management of gates in the ZTLs (Controlled Traffic Zone), for integrated ticketing, for the improvement of information available to users by exploiting the potential of the web and the mobile.
- **QUALITY OF SERVICES:** measuring systems based on ICT technologies so as to assess the quality of the services provided by Local Authorities. The goal is to improve services for users and the efficiency of its internal processes throughout advanced systems of Citizen Relationship Management (CiRM), highly interactive web portals, implementations to support the annual and multiannual programming, solutions for measuring organizational and individual performances, integration and upgrading of labour information systems (at the beginning, even though the labour-related projects were in a stand-alone group, then, during the assessment of the projects, they were absorbed by the quality of services field.).
- **TAXATION AND CADASTRE:** integrated digital management of local services concerning taxation and cadastre through cooperative application models. The aim is to increase the ability of overseeing and monitoring the territory, countering tax evasion and promoting tax equalization. Tax, civil registry services, construction industries: all

these fields of application are now the backbone of the organizations that adopted them.

Apart from the innovation communities born from the ELISA program, there's only another single MPG scheme that had a great success and that is worth citing, the COMMONWEB platform for civic engagement, services deployment and intercommunal collaboration, enacted without any help or involvement from central authorities by a "Consorzio" of all the local authorities of the Trentino Autonomous Province.

Paola Clerici Maestosi: Innovation Communities and sustainable/innovative management models: what's going on in your country?

Han Brezet: Nowadays, the MPG inspired approach in the Netherlands is not restricted to areas, in which the country performs already good, in the top-3, like measured in the European DESI-index (DESI, 2019). These scores include areas like connectivity, human capital, use of internet services, integration of digital technology and digital public services, all in relation to the Digital Economy and Society.

Also the poor sustainable development situation in the Netherlands, with for instance low scoring European positions in the energy transition and nature protection fields, has undergone an MPG impulse in recent years.

For instance, the energy transition area has adopted the new élan of co-design and co-makership in 'National Transition Agenda's', in which climate tables of involved stakeholders from all quadruple helix backgrounds have co-formulated future missions and goals of energy efficiency in production and consumption as well as renewable energy contribution. Specific roadmaps are envisaged and developed for each subsector, and the interim-results are promising so far (PBL, 2019a). A similar approach has been chosen for the National Agenda for the Circular Economy (PBL, 2019b). Again, these programs know their bottom-up



International Journal of Sustainable Energy Planning and Management

DIALOGUE

counterparts in cities and regions, and meet each other often at provincial -intermediary- level.

They still are -via the old NPM-line of thinking-side-supported with special, newly established institutes, such as the New Energy Coalition and the European Energy Academy in Groningen, Climate Adaptation Labs (in Rotterdam and Groningen) and the EBN (Energie Beheer Nederland) entity, calling itself ‘an entrepreneur in Dutch subsurface on behalf of the State’, at proper distance from the national government. (EBN, 2019).

Jonas Bylund: What we see is less of a programme, but more of ‘swarm intelligence’ forming around what we might call the necessity of boundary spanners. Similar to the notion of boundary objects, these are actors who works a lot ‘in between’, they are intermediaries that translate and connect between sectoral approaches, silos, between departments, public private and civil society, etc. This is also in-between the so-called vertical as well as so-called horizontal lines. Since most of any innovation and the challenges in public administration and urban governance faces ‘falls between the chairs’ nowadays, this figure is identified as at times already working in practice. But also as a resource, capacity, that we arguably need much more of – without having to ‘destroy the silos’ as we hear a lot in policy circles. Their work effects a kind of institutional thickness or density⁴ that is required to coordinate quite complex urban developments full of wicked issues.

Then, of course, in Sweden, as in many other European settings, we still have a kind of ecological modernisation attitude lingering in these matters. A remnant of 1980s–1990s technocratic approaches to urban sustainability, the ecological modernization approach means that, at times, required systemic transitions are still understood as technological feats to be performed ‘under the hood’ rather than by co-creation with affected actors

⁴ A notion that, if not coined by him, is used by Heiti Ernits to describe the ecologies needed for public administrations to tackle complex issues.

and that if anything threatens the comfort of the consumer, ‘acceptance’ has to be sought. This is of course in stark contrast to the approach in challenge-driven innovation to shape more robust solutions by early-on and transparent co-creation with multi-actor stakeholder groups, for example in urban living lab settings.

Giovanni Vetrutto: All the examples mentioned above give a very clear view on how much can be realized with an effective collaboration among different levels of government even in a country like Italy, that is at the last positions in the European DESI index (European Commission, 2018).

A report from the Politecnico of Milan University already showed some years ago that the small size of most local and regional authorities in Italy is not sufficient as economy scale level; and that an effective collaboration is needed to reach the pervasive goal that the new ICT models can assure in terms of administrative modernization (Department for Regional and Local Affairs & Politecnico di Milano - School of Management, 2014).

What is still missing in Italy is a systematic and comprehensive and conscious national strategy agreed among different levels of government, from the State down to the local authorities, in all the major fields of innovation.

What is happening, instead, is that in a lot of situations there are different arrangements of local, provincial, regional and rarely ministerial authorities to produce single projects and limited efficiency and effectiveness gains (Vetrutto, 2017).

Paola Clerici Maestosi: *Which is the relationship, in your country, between local authorities and central administration?*

Han Brezet: Historically speaking, the larger, strong cities (Amsterdam, Rotterdam, The Hague, Utrecht and Eindhoven), together with the region oriented



International Journal of Sustainable Energy Planning and Management

DIALOGUE

Provinces are the strong players in the intermediary innovation field.

Today, in most cities and provinces one will find Creative Councils and Innovation Boards who are (pro-) actively addressing local opportunities with local strengths, but also participating in the Government innovation agenda setting while creating their own programs, with support from the national government. Particularly, during the last ten years, a variety of new regional initiatives successfully have taken off, which align stakeholders from different perspectives and organizations, such as the RDM labs and facilities in the harbour area of Rotterdam, the ‘de Waag’ maker space in Amsterdam, the AMS (Amsterdam Metropolitan Solutions institute. (AMS, 2018)), a joint venture of MIT Boston, Delft University of Technology and Wageningen Research University, the high-tech campus with Philips and others in Eindhoven and the Water Campus and Alliance in the Province of Fryslan.

These local and regional lighthouses, including the Wadden Islands as testbeds for sustainable innovation have a relevant new role for the development of Dutch innovations. (Brezet, Belmane and Tijjsma, 2019).

Jonas Bylund: Strained. With a tradition or cultivation of a rather weak regional (county) level for the last 500 years. Although much of sustainability is, from a national government point of view, thought to happen by the regional catalyst, this territorial scale of administration is more of an outline than a substantial driving force in governance (apart from the management and delivery of specific services such as health care and police). This may account for a kind of constant question-mark and even mismatch in general in Sweden towards the logic in the EU around structural funds and programmes aimed at supporting regional development. The municipalities, then, closely guards and covets their almost sovereign mandate to rule/manage land-use issues (again, barring issues of national interest/importance). So, for a country that politically and administratively during large parts of the 20th Century has been managed by strongly

consensus-oriented procedures, there is a kind of peculiar local governance individualism and fragmentation that the regional county level cannot always be very effective facilitating and coordinating towards functional regional sustainable development.

Giovanni Vetrutto: In Italy there has been, especially from the late 90’s, a strong preference of political parties and governments for the empowerment of regions and not of local authorities; that preference came from political and tactical reasons and produced a number of limits in territorial policies in Italy; the most important one is the absence of a clear and organic urban strategy (Vetrutto 2019).

Each region has a sort of limited but strong autonomy in leading reform projects for their local authorities; in a very small country with a high number of regions, in many cases very little, this is definitely a problem (Caporossi 2019).

When a strong attempt to reform the juridical basis of all the administrative system of local, provincial and regional authorities, with an important law of April 2014, it produced very limited results, due to a very faint implementation attempt (Vetrutto 2016).

Paola Clerici Maestosi: *In which way European structural Funds contribute to shift from New Public Management to Multilevel Public Governance?*

Han Brezet: In the Netherlands, the role of European Structural Funds has been particularly strong in the more remote regions, like in the North of the country. Special organizations, overarching more provinces and smaller cities, have been set up, to deal with the ESF in regions. For instance the SNN (Samenwerkende Noord-Nederlandse instellingen) program covers three provinces, a number of regional cities and representatives of the quadruple helix in its board. Compared to a number of years ago, the ESF-programs are modernized, following MPG insights. For instance, the Operational Program North (OP Noord)



promotes innovation and entrepreneurship in the context of societal -smart RIS-specialisation- challenges like climate change, health, food security, water, energy. It stimulates participative innovation and living labs to establish the region as a test bed for innovation. Compared to the traditional approach of taking winners and sectors as starting point, the North ESF program starts with challenges, “willers” and is mission-oriented, following Mazzucato (Mazzucato, 2018). Moreover, a programmatic approach is considered essential compared to the regular project-to-project improvisation, building a systematic knowledge position and helping to strengthen the regional innovation eco-infrastructure. (Brezet, Belmane and Tijmsa, 2019.)

Jonas Bylund: As just mentioned, in Sweden, the role of European Structural Funds has been a question-mark and even mismatch in general towards transnational programmes aimed at supporting regional development for the first decades of joining the EU. However, the Swedish regions and municipalities are learning how to handle them more and more.

Giovanni Vetrutto In Italy the contribution of European Structural Funds to the reshaping of the different public administration territorial levels has been very weak.

The effective and quick use, in strategically orientated way, of these funds has never been a reality.

In the last two septennial periods of European programming Italy has shifted to the last positions on every classification, becoming late on its own standards for the amount of resources spent, for the time of spending, for the effectiveness of results produced (Barca 2011; Barca 2018).

In this context, the policies funded with the national operational program on governance were in line with this ineffective trend.

Acknowledgement

This article is a part of the EERA Joint Programme on Smart Cities’ Special issue on Tools, technologies and

systems integration for the Smart and Sustainable Cities to come (Østergaard and Maestosi 2019)

References

- Bäck, H. (2003). Party Politics and the Common Good in Swedish Local Government. in *Scandinavian Political Studies*, 26(2), 93–123.
- Barca, F. (2011). *La coesione territoriale in Italia alla fine del 2011. Relazione alle Commissioni Bilancio di Camera e Senato del Ministro per la coesione territoriale.*
- Barca, F. (2018). *Politiche di coesione: tre mosse*, Roma, IAI, April 2018, 13 p.
- Barrett, S. (2004). Implementation studies: Time for a revival? Personal reflections on 20 years of implementation studies. *Public Administration and Development*, 82(2), 249–262.
- Bobbio, N. (1974). *La grande dicotomia*, in *Studi in memoria di Carlo Esposito* (pp. 2187–2200). Padova, Italy: CEDAM.
- Brezet, J.C., N. Belmane & S. Tijmsa, 2019. The Tipping Guide – The Innovation Program’s Perspective for the new Governance of Islands. Province of Fryslan, The Netherlands. www.fryslan.frl/islandsofinnovation
- Caporossi, P. (2019). *W le Regioni?*, Soveria Mannelli, Italy: Rubbettino
- Castells, M. (2010). *The rise of the network society. The information age* (2nd ed.). In Blackwell Publishers (ed.), *Economy, Society and Culture*, 1. Oxford, England: Wiley Blackwell.
- Celik, S., 2018 Doctoral dissertation. On the Paradoxical Nature of Innovation. Evidence from Social Networks in Fryslân. Delft University of Technology. The Netherlands.
- Ceschin, F. & I. Gaziulusoy, 2019. *Design for Sustainability – A Multi-level Framework from Products to Socio-Technical Systems.* Routledge, London and New York. Free downloadable from: www.taylorfrancis.com
- Christensen, T., & Laegreid P. (2006). *Agencification and the regulatory reform.* In T. Christensen, & P. Laegreid (Eds.), *Autonomy and regulation: coping with agencies in the modern state.* (pp.8–49). Cheltenham, England: Edward Elgar.
- Conti, A. & Vetrutto, G. (2019), *ICT from below: ELISA program and the innovation of local government in Italy*, in *International Journal of Social Science Studies*, vol. 7, n. 3, p. 70.



International Journal of Sustainable Energy Planning and Management

DIALOGUE

- Dahrendorf, R. (1959). *Class and class conflict in industrial society*, Stanford, CA: Stanford University Press.
- Dahrendorf, R. (2003). *Libertà attiva. Sei lezioni su un mondo instabile*, Bari, Italy: Laterza.
- Department for Regional and Local Affairs & Politecnico di Milano - School of Management. (2014). *Reti di Città Intelligenti. Risultati e prospettive Programma ELISA*. Milano, Italy: Politecnico di Milano, 2014. Retrieved from <http://www.affariregionali.it/media/169091/labegov.pdf>
- DESI, 2019. DESI2019-Netherlands_ENG.pdf
- Dunleavy P., Margetts H., Bastow, S. & Tinkler, J. (2005). *New public management is dead-long live digital-era governance*. *Journal of Public Administration research and theory*, 16(3), 467–494.
- Ebn, 2019. <https://www.ebn.nl/en/>
- EC. (2011). *Cities of tomorrow: Challenges, visions, ways forward*.
- European Commission 2019. *Urban agenda for the EU Multi-level governance in action*. EC, Bruxelles, 2019. https://ec.europa.eu/regional_policy/sources/docgener/brochure/urban_agenda_eu_en.pdf
- European Commission n.d. A. *Urban Agenda for the EU*. EC, Bruxelles. <https://ec.europa.eu/futurium/en/urban-agenda>
- European Commission n.d. B. *Cohesion Policy*. EC, Bruxelles. https://ec.europa.eu/regional_policy/en/2021_2027/
- Advanced Metropolitan Studies (AMS), 2018. <https://www.ams-institute.org/>
- European Commission, 2018. *A Clean Planet for all: A European strategic long-term vision for a prosperous, modern, competitive and climate neutral economy*. COM(2018) 773 final. EC, Bruxelles, 2018 <https://eur-lex.europa.eu/legal-content/EN/TXT/PDF/?uri=CELEX:52018DC0773&from=EN>
- European Commission. (2018). *Digital economy and society index (DESI) 2018*. Country profile Italy. European Commission. http://ec.europa.eu/newsroom/dae/document.cfm?doc_id=52226
- European Design Innovation Initiative, 2012. *Design for Growth & Prosperity*. Report and Recommendations of the European Leadership Board. DG Enterprise and Industry. Thomson and Keskinen eds. Unigrafia, Helsinki, Finland.
- European Union 2018: *Pilot Action. Regions in industrial transition*. European Union, Bruxelles, 2018 https://ec.europa.eu/regional_policy/sources/docgener/informat/industrial_transition/pilot_industrial_transition.pdf
- Florida, R., 2012 *The Rise of the Creative Class*. BASIC BOOKS, New York.
- Geels, F.W., B. Elzen & K. Green, 2004. *Understanding Systems Innovation: A Critical Literature Review and a Conceptual Synthesis*. In: *System Innovation and the Transition to Sustainability*. Cheltenham, Northampton, Edward Elgar, 19–47.
- Guy Peters, B., & Pierre J. (1998). *Governance without government? Rethinking Public Administration*. *Journal of Public Administration research and theory*, 8(2), 223–243. <https://doi.org/10.1093/oxfordjournals.jpart.a024379>
- Hall, P. (2013). *NPM in Sweden: The risky balance between Bureaucracy and Politics*. In Å. Sandberg (Ed.), *Nordic Lights: Work, management and welfare in Scandinavia*. Stockholm: Studieförbundet Näringsliv och Samhälle.
- Hidalgo, C. A., Klinger, B., Barabási A., Hausmann L. (2007). *The Product Space Conditions the Development of Nations in Science*, 317, 482–487.
- Hirschman, A. O. (1958). *The strategy of economic development*. New Haven, CT: Yale University Press <https://doi.org/10.1177/000271625932500118>
- Hirschman, A. O. (1963). *Journeys towards progress*. New York, NY: The Twentieth Century Fund.
- Hirschman, A. O. (1967). *Development projects observed*, Washington, DC: The Brookings Institution. <https://www.pbl.nl/en/publications/outline-of-the-circular-economy>
- Marres, N. (2010). *Front-staging Nonhumans: Publicity as a Constraint on the Political Activity of Things*. In B. Braun & S. J. Whatmore (Eds.), *Political Matter: Technoscience, Democracy, and Public Life* (pp. 177–210). Minneapolis: University of Minnesota Press.
- Mazzucato, M., 2018. *The Entrepreneurial State. Debunking public versus public sector myths*. Penguin, London UK.
- Ministerie OCW, 2018. *Nationale Wetenschapsagenda* In: <https://wetenschapsagenda.nl/landingpage/index.html>
- Ministerie OCW, 2019. *Brief over de Uitkomsten van de eerste call van de Nationale Wetenschapsagenda*. Ministerie van Onderwijs, Cultuur en Wetenschappen, The Hage, Netherlands, July 12th, 2019
- Mostert, E., 2017. *Between arguments, interests and expertise: the institutional development of the Dutch water boards, 1953-present*. In: *Water History*, 9(2), 129–146.



International Journal of Sustainable Energy Planning and Management

DIALOGUE

- Mukhopadhyay, S. & W.A.G.A. Bouwman, 2019. Orchestration and governance in digital platform ecosystems. In: *Digital Policy, Regulation and Governance*, 21(4), 329–351.
- OECD, 2009. *Innovation in Firms: A Microeconomic Perspective*, OECD, Paris 2009
- OECD. (2005). *Modernizing Government. The way forward*. Paris, France: OECD Publications. <https://doi.org/10.1787/9789264010505-en>
- OECD. (2011). *Fostering Innovation to Address Social Challenges*. Retrieved from <http://www.oecd.org/sti/inno/47861327.pdf>
- Osborne, D., & Gaebler, T. (1992). *Reinventing government: How the entrepreneurial spirit is transforming the public sector*. New York, NY: Addison Wesley. <https://doi.org/10.1002/pam.4050130113>
- Østergaard and Maestosi 2019. *Tools, technologies and systems integration for the Smart and Sustainable Cities to come*. Int J Sustain Energy Plan Manag 2019;24 2019. <http://dx.doi.org/10.5278/ijsepm.3450>
- Ostrom, E. (1990). *Governing the commons. The evolution of institution for collective action*. Cambridge, UK: Cambridge University Press. <https://doi.org/10.2307/3146384>
- PBL, 2019a. *Klimaat- en energieverkenning 2019*. Planbureau voor de Leefomgeving. <https://www.pbl.nl/publicaties/klimaat-en-energieverkenning-2019>
- PBL, 2019b. *Outline of the circular economy*. Planbureau voor de Leefomgeving.
- Polanyi, K. (2013). *Per un nuovo occidente. Scritti 1919- 1958*, Milano, Italy: il Saggiatore.
- Pollitt, C., & Bouckaert, G. (2004). *Public management reform: A comparative analysis* (2nd ed.). New York, NY: Oxford University Press.
- Rennie, R. (2005). *Sostenere l'innovazione nelle pubbliche amministrazioni*. Queste Istituzioni, 136/137, 101–115. Roma, Italy: QUES.IRE.
- Smith, M.E., 1992. Braudel's temporal rhythms and chronology theory in archeology. In Knapp 1992, *Anales, Archeology and Ethnohistory*.
- Sovacool, B.K. & D.J. Hess, 2017. Ordering theories: Typologies and conceptual frameworks for sociotechnical change. In: *Social Studies of Science*, 2017. Vol 47 (5) 703–750.
- UN, 2017. *The Sustainable Development Goals 2017*. United Nations, New York, USA.
- Verhoest, K., (2017). *Agencification in Europe*. In E. Ongaro, & S. van Thiel (Eds.), *The Palgrave Handbook of Public Administration and Management in Europe*, (pp. 327–346). Basingstok, UK: Palgrave Macmillan. <https://doi.org/10.1057/978-1-137-55269-3>
- Vetritto, G. (2010). *Di cosa parliamo quando parliamo di pubblica amministrazione*. Queste Istituzioni. 156/157, 7–16. Roma, Italy: QUES.IRE.
- Vetritto, G. (2016). *L'Italia da rammendare. Legge Delrio e ridisegno del sistema delle autonomie*. Rivista giuridica del Mezzogiorno, 1, 153-171. <https://doi.org/10.1444/83297>
- Vetritto, G. (2017, June 22). *Community d'innovazione, il modello pubblico che sta cambiando il territorio*. In *Agendadigitale.eu*. Retrieved from: <https://www.agendadigitale.eu/cittadinanza-digitale/governare-la-complessita-facendo-sistema-le-community-d-innovazione/>
- Vetritto, G. (2019), *La "lentissima fondazione" delle autorità metropolitane*. Rivista Italiana di Public Management, vol. 2, n. 1
- Wolfram, M. (2018). Learning urban energy governance for system innovation: an assessment of transformative capacity development in three South Korean cities. *Journal of Environmental Policy and Planning*, 21(1), 30–45.

International Journal of Sustainable Energy Planning and Management

CONTRIBUTIONS

Opening authors



Paola Clerici Maestosi

ENEA, Italian National Agency for New Technologies, Energy and Sustainable Economic Development.



Paolo Civiero

IREC, Catalonia Institute for Energy Research.



Gilda Massa

ENEA, Italian National Agency for New Technologies, Energy and Sustainable Economic Development.



Poul Alberg Østergaard

Aalborg University.

International Journal of Sustainable Energy Planning and Management

CONTRIBUTIONS

Research and experimentation authors

Poul Alberg Østergaard.

Aalborg University

Paola Clerici Maestosi.

ENEA-Energy Technologies Department

Paolo Civiero.

IREC Catalonia Institute for Energy Research

Gilda Massa.

ENEA-Energy Technologies Department

Sara Ben Amer.

TUD Technical University of Denmark

Rasmus Bramstoft.

TUD Technical University of Denmark

Olexandr Balyk.

TUD Technical University of Denmark

Per Sievert Nielsen.

TUD Technical University of Denmark

Maria Alessandra Ancona.

University of Bologna

Michele Bianchi.

University of Bologna

Lisa Branchini.

University of Bologna

Andrea De Pascale.

University of Bologna

Francesco Melino.

University of Bologna

Antonio Peretto.

University of Bologna

Maciej Widzinski.

MP PAN, Gdańsk

Patryk Chaja.

IMP PAN, Gdańsk

Anders N. Andersen.

Aalborg University - EMD International A/S

Marta Jaroszevska.

IMP PAN, Gdańsk

Sebastina Bykuc.

IMP PAN, Gdańsk

Jakub Sawicki.

IMP PAN, Gdańsk

Verena Heinisch.

Chalmers University of Technology

Lisa Goransson.

Chalmers University of Technology

Mikael Odenberger.

Chalmers University of Technology

Filip Johnsson.

Chalmers University of Technology

Tanja Totzer.

AIT Austrian Institute of Technology

Romana Stollnberger.

AIT Austrian Institute of Technology

Roland Krebs.

Superwien urbanism ZT OG

Mara Haas.

Superwien urbanism ZT OG

Christoph Biegler.

Fraunhofer Austria Research GmbH

Anna Dziadkiewicz.

University of Gdańsk

Elisa Cassinandri.

Municipality of Milan

Elisa Gambarini.

Municipality of Milan

Roberto Nocerino.

Poliedra, Politecnico di Milano

Lucia Scopelliti.

Municipality of Milan

Carola Clemente.

Sapienza University of Rome

Marilysa Cellurale.

Sapienza University of Rome

Sabrina Romano.

ENEA – Smart Energy Division

Martina Botticelli.

Marche Polytechnic University

Francesca Dionisi.

Sapienza University of Rome

Ivan Dochev.

HafenCity University Hamburg

Hannes Seller.

HafenCity University Hamburg

Irene Peters.

HafenCity University Hamburg

Francisco Javier Miguel-Herrero.

Fundación CARTIF

Victor Ivan Serna-Gonzalez.

Fundación CARTIF

Gema Hernandez-Moral.

Fundación CARTIF

Sergi Taraglio.

ENEA – Smart Energy Division

Stefano Chiesa.

ENEA – Smart Energy Division

Luigi La Porta.

ENEA – Smart Energy Division

Maurizio Pollino.

ENEA – Smart Energy Division

Marco Verdecchia.

University of L'Aquila

Barbara Tomassetti.

University of L'Aquila - CETEMPS

Valentina Colaiuda.

University of L'Aquila - CETEMPS

Annalisa Lomabardi.

University of L'Aquila - CETEMPS

Savis Gohari.

NTNU

Stig Larssaether.

NTNU

Francesca Cappellaro.

ENEA - SSPT Dept. for Sustainability

Roberta Chiarini.

ENEA - DTE-SEN Energy Dept.

Claudia Meloni.

ENEA - DTE-SEN Energy Dept.

Claudia Snels.

ENEA - DTE-SEN Energy Dept.

Peter Berkowitz.

DG for Regional and Urban Policy EC

Han Brezet.

TU Delft

Jonas Bylund.

IQ Samällsbyggnad

Giovanni Vetrutto.

Council of Ministries Presidency, Italy



International Journal of Sustainable Energy Planning and Management

CONTRIBUTIONS

Acknowledgement of value stakeholders

Silvio Alessandrini.

Head of Automation and Innovation Technologies for the Network - Areti (Acea)

Daniela Baer.

Researcher, SINTEF, Norway

Niels Bethlowsky Kristensen.

Climate and energy planner in the City of Copenhagen

Ercole De Luca.

Innovation – Grid Flexibility & Dispatching, Areti

Biagio Di Pietra.

Senior Researcher, ENEA-UTEE (Technical Unit for Energy Efficiency)

EREN.

Spain

Francesca Hugony.

Researcher, ENEA - National Energy Agency, Italy

Alexandre Lemille.

Advocate of a Circular Economy 2.0, adviser on EU H2020 and Interreg projects

Kjerstin Ludvig.

Project management NEPP

Ubaldo Occhinegro.

Council Representative for Urban Planning - Construction, Mobility and Strategic Plans, Municipality of Taranto, Italy

Dario Pulcini.

Councilor for Environmental Policies, Municipality V – Roma Capitale

Roland Schwörer.

Renewable Energy – Heat Concepts, Hamburg Ministry of Environment and Energy

Dariusz Wojtas.

Chairman of the Board of Municipal Thermal Energy Company in Ostrowiec Świętokrzyski, Poland

Theodor Zillner.

Austrian Ministry for Transport, Innovation and Technology, Energy and Environmental Technologies

International Journal of Sustainable Energy Planning and Management

CONTRIBUTIONS

Dialogues virtual round table participants



Paola Clerici Maestosi

Scientific Board Coordinator for the special issues serie EERA Joint Programme on Smart Cities.
Coordinator for WP Academy EERA JPSC.
Vice-chair Joint Programming Initiative Urban Europe.
Vice-chair SET.Plan action 3.2.
Senior Researcher, ENEA, Italian National Agency for New Technologies, Energy and Sustainable Economic Development.



Peter Berkowitz

Head of Unit - Smart and Sustainable Growth Directorate General for Regional and Urban Policy European Commission



Han Brezet

Professor Department Design, Engineering, section Design for Sustainability, TU Delft (NL)



Jonas Bylund

Programme Manager, IQ Samällsbyggnad, (SE)



Giovanni Vetrutto

Head office for Urban policies, institutional modernization and International activity, Department for regional Affairs, Council of Ministries Presidency (IT)

International Journal of Sustainable Energy Planning and Management

CONTRIBUTIONS

EERA Joint Programme on Smart Cities full members



International Journal of Sustainable Energy Planning and Management

CONTRIBUTIONS

EERA Joint Programme on Smart Cities associated partners

